

**Exploring Circumcision: History, Myths, Psychology, Restoration,  
Sexual Pleasure, and Human Rights**

**The  
Joy of  
Uncircumcising!**

**Jim Bigelow, Ph.D.**

**Foreword by  
James L. Snyder, M.D.**

**Intentionally Blank Page**

---

# The Author's Preface to the Electronic Edition

---

## **“THE JOY OF UNCIRCUMCISING, Exploring Circumcision: History, Myths, Psychology, Restoration, Sexual Pleasure and Human Rights”**

Copyright © 1992, 1995, 1998, 2002 by Jim Bigelow, Ph.D.

All rights reserved. No part of this book may be reproduced for profit in any form without written permission from the author.

This book may be downloaded and printed for personal use following payment to the National Organization of Restoring Men (NORM) at [www.norm.org](http://www.norm.org) via PayPal (online payment, including international and credit card payments) or other method listed on the website. If you need to contact NORM via a method other than the web site please see the resources section at the end of this book for our mailing address and phone number.

### **INTRODUCTION TO THE ELECTRONIC VERSION**

The last updated information that was available in the printed book is found in the 1998 BULLETIN. Since then, several major research papers have been published, and in addition there have been two international symposia. Furthermore, there have been two marches on Washington, D.C., as well as important legislative action in several states. Information on the research and other issues is available through NOCIRC at [www.nocirc.org](http://www.nocirc.org) as well as Circumcision Information and Resource Pages at [www.cirp.org](http://www.cirp.org).

### **CHAPTER NOTES**

The following errata are included here and at the beginning of each indicated chapter. Note that sixteen needs to be added to the page numbers listed in the table of contents and the index as these refer to a printed version of the book

CHAPTER 4 The research presented in this chapter has been greatly expanded in several instances. For latest research, see introduction above.

CHAPTER 10 The original intent of this chapter was to present a variety of theoretical positions in the hope that such a presentation would spark further research regarding the psychological aspects of circumcision, circumcisers, and the circumcised. Due to this intent, the chapter may seem to the casual reader to be unnecessarily complex. There are still many unanswered questions, and it is hoped that those in the field of psychology will take up this issue more thoroughly.

CHAPTERS 15 through 18 These chapters are presented here as in the original publication. In 1992 this information was the most current thinking about foreskin restoration. Since that time, a number of additional methods and devices (both home made and commercial) have become generally available. For more current information, see the National Organization of Restoring Men [www.norm.org](http://www.norm.org).

CHAPTER 19 This chapter has been retained for historical purposes. The surgical touch ups suggested here have not proven successful in most cases. Therefore, it is suggested that the individual continue the restoration process until sufficient tissue has been produced to effect more reliable coverage of the glans.

CHAPTER 20 While many men would desire a 'quick fix' to regain a foreskin, the trends in surgical reconstruction have not proven sufficiently reliable to date to warrant recommendation. (See position statement at [www.norm.org](http://www.norm.org)). This chapter is presented here for historical completeness as in the original publication.

*The most significant restoration discussed in this book is not that of the foreskin but of CHOICE, a choice restored to those from whom that right was taken when they were too young to defend themselves.*

*Therefore, this book is dedicated to those circumcised men who cannot still the voice of their own indignation...especially those who have believed that there is no hope.*

#### **Notice**

Nothing in this book is meant as, or should be taken as, medical advice. If you are interested in foreskin restoration, consult a physician. Because no two individuals are the same and you are likely to have special needs, all restoration activities should be carried out under the supervision of a physician. Of necessity, neither Hourglass Books nor the author make any guarantees concerning the information or techniques contained in this book or the uses to which they are put. Products mentioned in this book are cited for information only and are not recommended or guaranteed.

#### **Voices' Note**

Except where full name or specific source is noted, the letters cited throughout this book were received by UNCIRC, NOCIRC, NORM, NOHARMM, Gulf Coast Infant Circumcision Information Center, etc. The letters, including the initials and city or state at the end of each one, have been edited to conceal the identity of the writer and also for length and conventional terminology.

Copyright © 1992, 1995, 1998 by  
Jim Bigelow.

All rights reserved. No part of this book may be reproduced in any form without written permission from the publisher.

Printed in the United States of America.

ISBN 0-934061-22-X

---

# Foreword

---

When a young man first discovers the power of his own sexuality, it is always an unforgettable event. For most men, there follows a period, perhaps a lifetime in duration, of interest in human sexuality and in the structures of his own body, and those of others. Natural curiosity will lead most young American men to discover that most American penises are circumcised, but that some are not. Whether this discovery leads to regret and a desire to regain what has been lost is one of the important subjects of this book.

Most of the men of the civilized, modern, industrial world will grow to maturity in societies that do not circumcise their infant males. In these countries a male child will be left to grow to maturity with the normal anatomy which nature intended, including a foreskin on his penis. However, some primitive societies subject both their male and their female children to various forms of genital alteration with the stated purpose of making them more beautiful, cleaner, or to protect them from disease or disgrace. A recital of the benefits of female circumcision from a member of a society which forces that mutilation on its little girls will sound much like the reasons given for circumcision of little boys in America. Why does this happen in our American society, which prides itself on being the most open and progressive society on Earth? Just why is circumcision done? Does it really help? What is lost in a circumcision? Can mistakes be made? Can the lost parts be replaced? These are all major questions which this book addresses.

The author, in estimating the number of American men who have negative feelings about the circumcision which was forced upon them as an infant, reckons up a number in the millions. In my own independent calculations I have estimated that probably 90% of the 125 million American men are circumcised. If only 1 % of that number regret the fact of their circumcision for any reason, there are over 1 million American men who should be acutely interested in the contents of this book. For others, the matter has been rationalized away (“...a complete denial to the point of no conscious feelings or attitudes relative to the circumcised state”). It is the hope of the author, myself, and others, that this book will reach the one million or more men who are its natural audience...those who consider their circumcision to have been an assault on their bodies...those who are desperate to find information on what has happened to them...and those who seek sympathy and help for their wounds.

There is no doubt that some will find this a controversial work. I have found that discussion of the topic of circumcision, circumcision complications, and foreskin restoration before audiences of physicians has produced reactions ranging from

disbelief to hostility. Physicians like to believe that everything they do is for the benefit of their patients and grounded upon scientific fact. For most of them, the thought that their own circumcision—or the one they have just recommended for a child—is harmful, is a threat to their professional integrity. No doubt some or all of this reaction is a defense mechanism by which the circumcised male builds elaborate explanations as to the good reasons it was done to him.

Some physicians have gone on record recommending routine newborn circumcision as a public health measure to prevent venereal disease, venereal warts, and even AIDS. The fact that we are seeing an increasing incidence of all these and other sexually transmitted diseases in a population that is essentially a circumcised population only seems to increase the calls for more circumcisions. But circumcision has been shown to be ineffective in preventing these same diseases. After all, why should we have vocal street demonstrations demanding more research into the cause and cure of AIDS if a simple circumcision is all that is needed to make the problem go away?

The author, a Doctor of Psychology, has treated this subject with the skill and sympathy it deserves. Strangely, the vast majority of physicians, who are sworn to use their knowledge and skills to serve the sick and to heal the wounds of humanity have been indifferent to the feelings of injury which circumcision has created in significant numbers of men. A woman who has suffered a disfiguring breast injury or surgery for cancer can expect to receive sympathetic and skilled efforts at reconstruction of her breast. A man who has suffered loss of an arm or a foot can expect and receive highly skilled efforts to restore both form and function. But the same man who wishes to have restoration of the normal form and function of his circumcised penis will have to endure indifference, curiosity, and hostility from many physicians. This book fills the gaps of information which the medical profession has yet to address. The author has combined the information from many sources, including the experience of lay groups pursuing foreskin restoration and the gradually increasing medical literature and experience, to make this book authoritative, informative, and highly readable.

The final benefit to be gained by the publication of this book is that it will increase the fund of information available to laypeople, especially young parents, to arm them to oppose the continued practice of routine newborn circumcision by physicians.

**James L. Snyder, M.D., FACS**  
Past-President of the Virginia Urological Society

---

## “...and suddenly men began to scream.”

---

Marilyn Milos, R.N., the founder of NOCIRC, has said, “After I saw my first infant circumcision, I began my work to stop the screams of babies, and suddenly men began to scream.”

- What circumcision did to my body is bad enough, but what it did to my mind is worse.
- Adrenalin shoots through me when I hear the word ‘circumcised.’ I freeze.
- I think I could have accepted a deformity that was an accident of nature, but I can’t accept that someone *did* that to me.
- I was circumcised when I was five—70 years ago. I felt rage then and I still feel rage now.
- I envy my dog.
- I asked a friend if he felt ‘different’ when he was the only uncircumcised man in the shower and he said, ‘Yes—gloriously different.’
- I’m Jewish and I hate being circumcised.
- I couldn’t even make myself *say* ‘circumcised’ until I was in my 20s.
- The fact that other boys were circumcised too never made *me* feel any better.
- I used to think there were two kinds of boys: circumcised boys like me and *real* boys.
- My mother told me she could hear my screams from the other end of the hall.
- I have nightmares about being circumcised by force.
- I think of myself and other circumcised men as amputees.
- Fear, pain, crippling, disfigurement and humiliation are the classic ways to break the human spirit. Circumcision includes them all.
- The head of my penis is just dead.
- I never got used to being circumcised. I just learned to endure it.
- I feel that my father betrayed me by letting my mother have me circumcised against his wishes, and I’ve always sensed that deep down he rejected me because he saw me as damaged.
- My feelings about the doctor who circumcised me are too violent to describe.
- My greatest fear to this day is having a knife pulled on me.
- It hurt. It bled. It left an ugly scar.
- I’d give anything I own if I could wear a T-shirt with ‘INTACT’ printed on it and it could be true.
- I hate that word. The sound ‘cir...’ makes me shudder.
- What possible advantage could there be to removing from the penis its only movable part?
- I have wondered what it’s like to have a foreskin all my life.
- I tried several times to ask my mother about what had been done to me; but when I opened my mouth to speak, the words stuck in my throat and no sound came out.
- I was just a baby—I couldn’t stop them.
- I’m restoring my foreskin because I was born with one, and damn it, I’m going to die with one.

(collected and edited by John A. Erickson)

---

## Acknowledgment—First Edition

---

Marian Anderson, the great American Contralto, uses the plural pronouns, we and us, when referring to herself because “one realizes the longer one lives that there is no particular thing that you can do alone.” Miss Anderson’s sentiments are infinitely true where the writing of this book is concerned—‘we’ worked at all times with the unfailing support and cooperative labor of others.

First, I would like to thank my wife, Deb, for her constant support, understanding, and help. The writing of this book has absorbed nearly a year of our life. She has encouraged, typed, cooked and cleaned, worked at her own job, shielded me from interruption and responsibility, and literally made it possible for me to work day and night, often seven days a week, to complete this project. In every way, this is *our* book.

Two others have stood and worked along side me, both in my study and personal education and in my writing. Marilyn Milos was the first person I actually spoke to, in 1987, after I learned that I was not alone in my feelings of personal loss and woundedness due to circumcision. She has never failed to make her support, knowledge, and the resources of NOCIRC available to me. In many ways, this is *our* book. R. Wayne Griffiths and I began to work together when I first undertook to revise the restoration

instructional material early in 1990. From that time on, Wayne has made his time, labor, computer expertise, and even the hospitality of his home constantly available to me. Once again, in many ways, this is *our* book.

I must also express my gratitude to Edward Wallerstein, Rosemary Romberg, and Anne Briggs. Their landmark books provided me with a wealth of information, particularly for the first half of this book. Their pioneering efforts and documentation allowed me to tap in on resources I would never have known about without their earlier labors. I am truly indebted to each of them.

Behind the scenes are also those men who, for their own reasons, prefer to remain anonymous. Each of you know who you are. I thank you for the support, information, and trust you have given me in sharing your histories and knowledge with me. Please accept my heart-felt thanks.

I want also to express my appreciation to two members of my family, Michele and Eric, for their help with the very tedious task of proofreading the later drafts. Thank you so very much for your time, effort, and support.

Finally, I would like to express my gratitude to the publisher. To publish this book in the United States today takes real courage and daring. Thank you for taking a chance on me as an author and on the response of the men of this nation to this effort to bring a painful and, until now, hidden subject into the open.

**Jim Bigelow, 1992**

---

## Acknowledgment—Second Edition

---

I have continued to enjoy the same support from friends and family during my work on this second edition as was true while I wrote the first. A special note of gratitude is due, however, to my wife, Deb, whose serious illness during work on this revised edition in no way interfered with her urging me to finish the task. Once again, this book absorbed a large piece of our life, but there was never a hint of suggestion that I should abandon the project. This is still, in every way, *our* book.

Both Marilyn Milos and Wayne Griffiths deserve special thanks for their willingness to help evaluate the

added material and to undertake the difficult task of proofreading modifications, additions, and insertions to an existing text—there were times when it nearly drove us all ‘round the bend.’ As before, in so many ways, this is *our* book.

Finally, my thanks again to the publisher who has the courage to continue to make this book available. I trust the several reviews of the first edition by major medical journals, both in this country and abroad, have helped to repay the faith placed in this endeavor.

**Jim Bigelow, 1995**

---

# Introduction to the Second Edition

---

When the first printing of this book neared depletion, the question arose: should we simply reprint the original edition or publish a revised, expanded second edition? There were so many issues to consider. For instance, the restoration system, as described in the first edition, remains virtually unchanged except for the inclusion of a few additional tape products. On the other hand, new manufactured devices and/or methods have been introduced since the first edition was published. In addition, there have been several new developments worldwide, both in the fight against routine circumcision and in the restoration movement. It seemed important that these devices and developments be documented. Actually, the publication of the first edition of this book attracted a good deal of attention, particularly from the medical community and from the media.

One of the biggest surprises, however, in terms of attention to the book and to foreskin restoration itself, has been the international interest. Men from virtually every other English-speaking nation have responded—resulting in restoration information and support centers being formed in both England and Australia—as well as individuals and groups in other countries such as France, Belgium, and Germany seeking both information and cooperation. Clearly, untold numbers of circumcised men the world over are dissatisfied with what was done to them and are seeking a remedy.

Another issue which needed to be both acknowledged and addressed is the increasingly acrimonious debate over genital mutilation of children worldwide. While the current political and social focus is on female genital mutilation

(FGM), an ever-growing number of enlightened educators, politicians, health care providers, and social activists are recognizing that what is done to males is not fundamentally different—in terms of human rights and individual choice—from that which is so vigorously denounced in the Western world when female children are involved. Again, a larger story needed to be told.

Finally, the issue of foreskin restoration needed to be put into proper perspective. Some of the reviews of this book, as well as some press and media coverage, suggest that those who are active in the modern-day restoration movement are motivated by a need to indoctrinate and persuade circumcised men to restore their foreskin—a sort of search for disciples. Not so! It is true, however, that many of us who were circumcised as infants or young children decry the fact that we were given no choice. And choice is at the heart of both the restoration movement and this book. Personally, I have no desire to ‘convert’ any circumcised man who is content with his circumcised state to a program of restoration. I do, however, have a relentless desire to inform *every* circumcised man that, while he almost surely had no choice about his circumcision, he does have a choice as to whether or not to remain in that state. In terms of the inner self, choice is validating, liberating, empowering, and healing. And no other individual, family, medical or religious community, or social ideal has the right to deny the circumcised male this belated choice concerning his own body!

Therefore, in order to more thoroughly address these and other issues, this new, expanded edition is offered in the hope that it will help to further the cause of genital integrity for every child born upon the face of this planet.



# Bulletin—1998 Update

In the three years since the publication of the second edition of this book, the volume of interest, activity, and material related to stopping all forms of genital mutilation of children—of both sexes—has grown at such a rate that the following chronicle must be viewed only as representative of the many significant events, publications, and developments which have occurred.

## EVENTS

### **Fourth International Symposium on Sexual Mutilations, August 9-11, 1996, Lausanne, Switzerland**

After three sessions of the International Symposium on Circumcision (1989, 1991, & 1994), the Symposium became truly international with its first meeting abroad under its new title which encompasses all forms of genital mutilation on all persons under the age of consent. A Fifth Symposium is scheduled for August, 1998, in Britain (contact NOCIRC for further information).

### **American Academy of Pediatrics (AAP) Task Force Committee on Circumcision, June 1997, Chicago, IL**

Robert Van Howe, M.D., a leading opponent of routine infant circumcision, was invited as a consultant to make a 45 min. presentation but was kept for 1-1/2 hrs. as the Committee sought further information.

### **American Psychological Association (APA) Convention, August 15-19, 1997, Chicago, IL**

The APA was confronted, perhaps for the first time, with the possibility of adverse effects of infant male circumcision. The video, WHOSE BODY, WHOSE RIGHTS?, was shown at a regularly scheduled session and NOCIRC/NOHARMM had an information table. As a psychologist, I was very gratified to have fellow psychologists and related professionals thank us for being there, including remarks such as: 'It's about time'; 'At last'; and 'Keep up the good work.'

### **W Five, "Circumcision," October 21, 1997**

The Canadian Television Network show, W5, (similar to 60 Minutes or 20/20) aired a 12 min.

report following the publication of Dr. Margaret A. Somerville's statement (see below) that, "circumcision of baby boys is a criminal assault . . ." I believe this segment to be the most powerful national coverage of this issue to date in North America.

### **Association of Pre- and Perinatal Psychology and Health (APPAH), December 4-7, 1997, San Francisco, CA**

Robert Van Howe, M.D., served on a panel discussing "Cutting Edge Research." He dealt with the ineffectiveness of anesthetic during infant circumcision and noted that its use in no way vindicates the procedure.

## PAPERS AND PUBLICATIONS

**Denniston, George, M.D. & Milos, Marilyn F., R.N., eds.,** SEXUAL MUTILATIONS: A HUMAN TRAGEDY, New York, Plenum Press, 1997. (These are the proceedings of the Fourth International Symposium on Sexual Mutilations, August 1996, Lausanne, Switzerland.)

**Goldman, Ronald, Ph.D.,** CIRCUMCISION: THE HIDDEN TRAUMA, Boston, Vanguard Publications, 1997.

**Goldman, Ronald, Ph.D.,** QUESTIONING CIRCUMCISION: A JEWISH PERSPECTIVE, Boston, Vanguard Publications, 1998.

**Kayaba, Hiroyuki, et al.,** "Analysis of Shape and Retractability of the Prepuce in 603 Japanese Boys," JOURNAL OF UROLOGY, vol. 156, no. 5, 1996.

**Laumann, Edward O., Ph.D., et al.,** "Circumcision in the United States: Prevalence, Prophylactic Effects, and Sexual Practice," JOURNAL OF THE AMERICAN MEDICAL ASSOCIATION, vol. 277, no. 13, April 2, 1997.

**Somerville, Margaret A.,** interviewed by Sharon Kirkey, "Circumcising Baby Boys 'Criminal Assault,'" OTTAWA CITIZEN, Friday, October 17, 1997.

**Taddio, Anna, et al.,** "Effect of Neonatal Circumcision on Pain Response During Subsequent Routine Vaccination," LANCET, vol. 349, no. 9052, 1997.

**Taylor, John R., M.B., FRCP, et al.,** "The Prepuce: Specialized Mucosa of the Penis and Its Loss to Circumcision," BRITISH JOURNAL OF UROLOGY, vol. 77, 1996. (Dr. Taylor first presented his findings at the Second International Symposium on Circumcision, 1991. This is the long-awaited publication of his work.)

**Van Howe, Robert S., M.D.,** "Variability in Penile Appearance and Penile Findings: A Prospective Study," BRITISH JOURNAL OF UROLOGY, vol. 80, 1997.

## POSITION STATEMENTS OF MEDICAL SOCIETIES

In 1996, five medical societies in English-speaking countries issued statements opposing routine infant male circumcision: 1) Australasian Assoc. of Paediatric Surgeons, 2) Australian College of Paediatrics, 3) Australian Medical Assoc., 4) British Medical Assoc., 5) Canadian Paediatric Society, Fetus and Newborn Committee.

## RESTORATION ON THE INTERNET

Restoration information and resources have gone High Tech. While the number of web sites is constantly growing and their quality is varied, those interested in 'surfing the net' will find a great deal of interesting and informative material. Simple searches under key words such as *foreskin* and *circumcision* will now yield any number of sites with valid information. There is no doubt that this is only the beginning in terms of informing the circumcised men of the world that there is hope for their condition and that there are any number of ways they can help to stop routine male circumcision.

## PROFESSIONAL ORGANIZATIONS

- Attorneys for the Rights of the Child
- Doctors Opposing Circumcision (D.O.C.)
- Nurses for the Rights of the Child

For information on these and other affiliated groups, contact NOCIRC (see listing under RESOURCES).

---

# Contents

---

**1**

## **Why This Book?**

- To Give Circumcised Men Hope
- To Document Foreskin Restoration from Its Ancient Beginnings to the Present
- To Share All Available Credible Information About Modern-day Foreskin Restoration
- To Talk Honestly About the Sexual Advantages of Having a Foreskin
- To Provide Circumcised Men with a Dignified Voice
- To Bring the Hidden Pain of Infant Circumcision into the Open
- To Prepare the Therapeutic Community for Things to Come
- To Question the Psychological Impact of Infant Circumcision
- To Redefine Infant Circumcision as a Human Rights Issue
- To Place Infant Male Circumcision into a Worldwide Context
- To Inform Christians About the True Nature of Modern-day Circumcision
- To Tell Both the Good News and the Bad News

**1**

**2**

## **The Natural Penis**

- The Visible Anatomy of the Penis and the Foreskin
- Foreskin Development and Early Function
- Sensual Responsiveness of the Natural Penis
- The Pleasure Dynamic: A Sexual Function
- The Gliding Mechanism During Intercourse
- Prevalent American Attitudes Toward the Natural Penis

**11**

**3**

## **The Circumcised American Penis**

- The Glans Becomes an External Organ
- Loss of Sensual Sensitivity
- Problems Unique to the Circumcised Penis
- Reduced Sexual Functions of the Circumcised Penis
- Trouble-free Maintenance
- Circumcision in Older Children and Adults

**19**

---

# Contents

---

4

## Common American Myths About the Penis and Infant Circumcision

- The Foreskin Is Simply Redundant and Purposeless Skin Which Extends Beyond the *Actual Penis Itself*—A Mistake of Nature.
- The Intact Penis Is Very Difficult to Care for and to Keep Clean.
- Sooner or Later the Foreskin Is Likely to Cause a Serious Medical Problem; Therefore, the Individual Is Better Off Without It.
- The Infant Foreskin Should Function Normally at Birth; Unfortunately, Many Males Are Born with Phimosis Due to Adhesions Between the Glans and the Foreskin.
- Phimosis and Paraphimosis Are Common Developmental Problems in the Intact Older Child or Adult and Always Require Circumcision.
- Circumcision Is the Appropriate Preventive or Treatment for Urinary Tract Infection and Other Troublesome Irritations and Inflammations.
- Uncircumcised Males Are at Higher Risk for Venereal Disease than Are Circumcised Males.
- Having a Foreskin Puts the Male and His Sex Partner at Higher Risk for Cancer.
- Newborn Infants Do Not Feel Pain. Or, More Recently, They Do Feel Pain; But It Is Minor, of Short Duration, and Is Not Remembered. Therefore, the First Few Hours or Days of Life Are the Optimum Time for Male Circumcision to Be Performed.
- Routine Infant Circumcision Is Virtually Risk Free.
- Infant Circumcision Does No Harm to the ‘Penis Itself.’
- You Can Depend on Statistics.

29

5

## Common Circumcision Myths Which Cloud Social Issues

- Adult Males Do Not Like to Undergo a Circumcision; Therefore, It Would Be Best to Circumcise *All* Infant Males at Birth—It Is Kinder to Them.
- It Is the Right of the Parents, or a Medical or Religious Practitioner, to Make the Circumcision Decision for the Infant—After All, He Is Only a Baby.
- Circumcised Men Are Either Positive or Indifferent Relative to Their Circumcision Status.
- Many Less Sophisticated Cultures Circumcise Their Males, and Frequently Their Females, for Reasons of Rites of Passage, Markings, or Custom; But Americans Circumcise for Valid Medical Reasons.
- Those Men Who Do Resent or Dislike Their Circumcised State Are Emotionally Unstable and Are Probably in Need of Psychological Help.
- Men Who Actively Seek Foreskin Restoration Are Obsessed and Mainly Homosexual.

46

---

# Contents

---

**6**

## **The Development of Circumcision in Judaism**

- Origins of the Rite
- Milah
- Periah
- Messisa
- Questions and Issues Regarding the Circumcision Rite

**54**

**7**

## **Foreskin Restoration Among the Jews**

- Restoration During the Hellenic Period (323-30 B.C.)
- Restoration During the Early Roman Period (27 B.C.-cir. 140 A.D.)
- Jews and Foreskin Restoration Under Hitler (1930-1945)
- Jews and Modern-day Foreskin Restoration

**61**

**8**

## **America's 100-Year Infatuation with Circumcision**

- Victorianism in the Late 19th Century
- Surgical 'Treatments' for the Male Masturbator
- Surgical 'Treatments' for the Female
- Preventive Medicine
- The Reputation of the Foreskin in America
- The Style of the Typical American Penis
- Early Freehand Methods of Circumcision
- America's Tools of the Trade
- The Probe
- The Gomco Clamp
- The Plastibell
- The Advent of the Circumcision Board
- The Results of a Successful Circumcision
- Minor Mishaps—Oops!
- Complications of Difficult Circumcisions
- Circumcision and the Abnormal Penis

**69**

---

# Contents

---

**9**

## **Twentieth Century Christianity and Infant Male Circumcision in America**

- The Dawn of a New Christian Attitude Toward Male Circumcision
- A Careful Look at Old Testament Law and Ordinances as Medical Prescription
- Are the Old Testament Law and Ordinances Valid Medical Measures?

**83**

**10**

## **Psychological Factors Related to Infant Circumcision**

- Infant Male Circumcision as a National Phenomenon
- Infant Male Circumcision and the Medical Community
- Parents and Infant Circumcision
- Infant Circumcision and the American Male

**89**

**11**

## **Why Men Today Want to Uncircumcise**

- Common Reasons Men Give for Restoring Their Foreskin
- Psychological Motives for Foreskin Restoration
- Twentieth Century Foreskin Restoration Is Historically Unique

**113**

**12**

## **The Modern Foreskin Restoration Movement**

- The Unknown Independents
- The Earliest Record of Modern-day Surgical Foreskin Reconstruction
- Grassroots Movement: Early Networking
- Early Breakthroughs in Surgical Technology
- The Impact of the Intact Baby Movement
- Recent Books from the Perspective of the Intact Baby Movement
- Men's Self-help and Activist Organizations

**121**

---

# Contents

---

**13**

## **Skin Expansion: How It Works and What It Provides**

- How Does Skin Expansion Work?
- Skin Expansion Used in the Reconstruction of Male Genitalia
- Nonsurgical Foreskin Restoration Using Skin-expansion Principles
- What to Expect from a Restored Foreskin
- What Not to Expect from Foreskin Restoration
- Surgical Touch Ups to the Restored Foreskin
- The Restored Foreskin

**131**

**14**

## **The Skin- Expansion System Getting Started**

- Supplies and Implements
- Cautions
- The Fun Side
- Solving the Problems of Wearing Tape on Your Penis
- Solving Some Life-style Problems
- Advantages of the Skin-expansion System of Foreskin Restoration
- Disadvantages of the Skin-expansion System of Restoration
- Most Frequently Asked Questions
- Keeping Track of Your Progress
- Partner Support

**140**

**15**

## **The Skin- Expansion System Stage I— The Tape Strap**

- Three Basic Taping Methods
- Three Basic Tape-strap Procedures
- Nonrestricted Procedure
- Extended-wear Procedure
- Weighted Tape-strap Procedure
- Learning to Apply the Tape
- Initial Joys of Stage I
- More Joys of Stage I
- How Long Does Stage I Take?
- The Goal of Stage I

**152**

---

# Contents

---

**16**

## **The Skin-Expansion System Stage II—The Tape Ring**

- Three Basic Taping Methods
- Three Basic Tape-ring Procedures
- Nonrestricted Procedure
- Extended-wear Procedure
- Weighted Tape-ring Procedure
- Joys of Stage II
- How Long Does Stage II Take?
- The Goal of Stage II: The Point of Equilibrium

**161**

**17**

## **The Skin-Expansion System Stage III—Expansion Devices**

- The History of Homemade Expansion Devices
- When to Use an Expansion Device
- General Statement of Caution
- Three Basic Taping Methods
- Two Basic Expansion Devices
- The Foam Rubber Cone: Construction and Use
- Stainless Steel Ball Bearings in Tandem
- Extended-wear Weighted Device
- Initial Joys of Stage III
- Homestretch Joys of Stage III
- How Long Does Stage III Take?
- Setting a Final Goal
- Conclusion

**169**

**18**

## **Alternative Skin-Expansion Innovations**

- Do-It-Yourself
- Manufactured Devices and Methods
- Conclusion

**182**

**19**

## **Finishing Touches to the Restored Foreskin**

- Living with an Unruly Foreskin
- Surgical Touch Ups
- Electrolysis

**188**

---

# Contents

---

**20**

## **Trends and Options in Surgical Foreskin Reconstruction**

- The Platinum-ring Implant
- Z-plasty Techniques
- Free-graft Procedures
- Scrotal Graft with Implantation
- Rotated-graft Procedure
- Skin-expansion Techniques
- Advantages of Surgical Foreskin Reconstruction
- Disadvantages of Surgical Reconstruction
- Most Frequently Asked Questions
- Realistic Expectations of Surgical Reconstruction
- A Look Toward the Future

**193**

**21**

## **Cooperative Approach: Doctor and Client**

- One Success Story
- One Doctor's Ideas
- Future Developments

**206**

**22**

## **Where Do We Go From Here?**

- A Plea to the Medical Community
- A Message to Insurance Companies
- The Need for New Cultural Attitudes Toward Males
- A Demand for the Human Rights of Infant Males
- A Plea for Valid, Cross-cultural Research
- A Challenge to Cherished Beliefs and Traditions
- A Call for Political and Legal Action
- A Proposed National Registry
- The Need for Improved Networking Among Interested Men
- Support Groups for Men Wounded by Circumcision
- Activism: A Good Way to Channel Bad Feelings

**208**

<b>Postscript</b>	<b>222</b>
<b>Notes</b>	<b>222</b>
<b>References</b>	<b>231</b>
<b>Glossary</b>	<b>235</b>
<b>Resources</b>	<b>236</b>
<b>Index</b>	<b>238</b>



# 1

## Why This Book?

*“When women want to enlarge a perfectly normal (sized) organ, the breast, they’ve gotten support and even encouragement. But when men want to **restore** a perfectly **normal** and **useful** part of their bodies, that was removed from them against their will, (some suggest) they have to undergo psychiatric exams....I just don’t get it.”*

**Dean Edell, M.D.**

Radio and TV physician

Lately, when I meet a friend or acquaintance I haven’t seen for awhile, the *routine* is absolutely predictable:

Them: What are you doing these days?

Me: I’ve written a book.

Them: Oh, what’s the book about?

Me: The history and techniques of foreskin restoration.

Them: Come on, I’m serious; what’s the book about?

Me: I’m serious too, foreskin restoration.

Them: Why would anyone write a book about that?

Here’s why—

### To Give Circumcised Men Hope

I grew up believing that I was the only circumcised kid who wished it hadn’t been done to him. I wondered why it had been done to me, and I wondered what the doctor did with it after he cut it off. I grew up in a rather strict religious tradition that believes in healing through prayer. And I often prayed that God would heal my foreskin and give it back to me. As I got older, and my foreskin wasn’t healed, I tried to convince myself that it was, no doubt, for the best. And, as I married and had children of my own, I talked quite convincingly to myself and to my friends who were also becoming fathers just how proper and wise routine circumcision was. I fit in!

But, the feelings of loss and violation never went away, neither did the wish that I had my foreskin back. But, of course, I knew that was impossible. And, like most men in this country, I got on with my life. And I kept my mouth shut about my feelings. You really only have to be laughed at a few times to learn to keep some things to yourself.

### Men’s Voices...

“I have been looking for help for years and was about to give up when I stumbled onto UNCIRC. I would give anything to regain what I have lost. I can’t express how excited I am and how much I look forward to beginning the process.”

S.H., Chico, CA

“Unfortunately, at the age of eleven I was circumcised for ‘health reasons’ and more recently feeling very altered. Now the problems that have been caused by the circumcision are showing up as definite sexual problems. The loss or diminishing of sensation is the most problematic.

Not being a big advocate of surgery (but not totally out of the question either), I would like to explore the possibilities of the stretching method. Would you possibly have names of any men in the New York City area who have tried these techniques that I might be in contact. I certainly understand people’s right to privacy and would not want to interfere with it. Someone to talk to close to home would certainly be appreciated!”

C.W., New York

“I am actively participating in the stretching program outlined in your very sensitive and informative literature. Please wish me luck and stamina in completing this program. I’m sure I’ll

*(continued)*

### Men's Voices...

need it. I have no intention to give up—I have noticed significant increase in sensitivity in the three weeks that I have kept my glans covered and hope for continued improvement in this area. I'm happy that you have dedicated yourself to disseminating this information to the men who feel cheated by having been routinely circumcised as I was."

M.N., Pittsburgh

"I just read an article in the newspaper on the work being done by UNCIRC and I had to write. I am only 25 years old, but I have always felt that something was missing when I looked at my body. As a teenager, my best friend had a complete penis. I remember how I used to look at him and want the same thing. Now I've read that it is possible!

Please send me the book on restoration techniques. I can't wait to receive it."

B.I., Dearborn

"The article in Sunday's newspaper was fascinating. I had no idea other men were interested in the idea of possible restoration. I just assumed it was a futile idea until reading the article."

T.R., Detroit

"You can't know how happy I am that I found your organization. You are making a life-long dream come true, and the process as written is working wonderfully."

C.F., Brooklyn

"I must confess that it is really exciting to think that there is a process other than surgery that can restore the foreskin, and I am so glad to hear of an organization dedicated to the process. As neither my father nor my older brother were circumcised, I have had foreskin envy since I have been old enough to notice the difference!"

M.J., Wisconsin

"What can you tell me about foreskin restoration? I wish, as a child, I had never been circumcised."

S.D., Missouri

I was in my 50s when I saw a TV talk show discussing the practice of infant circumcision in this country and the fact that some men were restoring their foreskin. I couldn't believe what I was hearing: Other men didn't like being circumcised either, and something *could* be done about it. What a hope! True to my nature, I set about to acquire every piece of information I could find on the subject of foreskin restoration. I found that there was a burgeoning foreskin restoration movement, and I got increasingly involved. Early in 1990, I formed UNCIRC (UNCircumcising Information and Resources Center) as an information exchange center for men who, like me, want to keep informed on the subject.

This book, then, is the culmination of a lifetime of struggle and resignation and a few years of hope and progress. As a psychologist, let me assure you that these last few years of anticipation and accomplishment have done wonders to restore not only a sense of wholeness from an anatomical point of view but a sense of wholeness in terms of my body belonging to me. Every victim of every sort of childhood abuse will know the significance of that statement. And so, this book is written to bring hope to those circumcised men who have always believed that there was no hope or healing for either their physical or their psychological wounds.

### To Document Foreskin Restoration from Its Ancient Beginnings to the Present

This reason for writing the book is a little like the mountain climber who says that he climbed the mountain because it was there. To my knowledge, no book has yet set out to bring together in one document that which is known of foreskin restoration throughout history. I certainly do not flatter myself to imagine that this record is without error or omissions. And, no doubt, further literary research will add to that which is currently known to this author.

But, in spite of any shortcomings of this work, the story of foreskin restoration needs to be told in America today. The subject and the practice of foreskin restoration could hardly have had another place on earth or time in history when more millions of men are in the position to be at least curious or potentially interested at a personal level. And so, this book is written to document what I have been able to gather of the history and practices of foreskin restoration, particularly such information as may benefit the circumcised males of this generation.

## To Share All Available Credible Information About Modern-Day Foreskin Restoration

Each week or two someone writes to share a different taping procedure, or to describe a new ‘discovery,’ or to say that he has seen a doctor who suggested yet a different surgical technique. Therefore, the goal of sharing all available information is somewhat ambitious. On the other hand, many of the so-called discoveries and new techniques are, in fact, simply variations of those things which have been or are being done by others.

Nonetheless, the goal remains the same: to let men know as much as possible about what has been tried, what is being done, and what has produced results. No one knows at the present time just how many men have sought restorative help from doctors or embarked on some sort of foreskin restoration program. No one knows how many circumcised men wish they could do something to reverse their circumcision. What I do know is that the letters never stop coming, and circumcised men continue to ask for help. Therefore, this book is an earnest effort to share the accumulated knowledge about foreskin restoration in as comprehensible and useful a manner as possible. It is my desire that the information provided here will add substance to men’s hope that *something can be done!*

## To Talk Honestly About the Sexual Advantages of Having a Foreskin

We do not talk easily in our culture about sexual matters. And we don’t talk about the sex organs. Most particularly, we do not talk about the penis. And we certainly do not talk about the sexual fun and enjoyment provided by the foreskin. Because of our silence, and the resulting ignorance, we can rather easily be convinced that it is of absolutely no consequence one way or the other whether or not a male has his foreskin.

In fact, we have a very long history of appalling ignorance about such fundamental sexual functions as the female orgasm because it wasn’t polite to talk about such things. As late as 1969, the book, **EVERYTHING YOU ALWAYS WANTED TO KNOW ABOUT SEX\*** *\*but were afraid to ask*, became a runaway best seller chiefly because it did talk about a host of things you ‘just didn’t talk about’ (1).

Well, it’s time to talk far more openly about the male sexual response and the long-denied functional differences between the natural and the circumcised penis. It’s time for males to know that the differences are very real. Circumcision does not provide added benefits; rather, it is the subtraction of very natural sexual functions.

### Men’s Voices...

“Regarding foreskin restoration, I’ve wondered about this off and on for years and want to explore and learn all I can about it. It’s reassuring to know I haven’t been the only one out there.

I look forward to hearing from you, and if you have a mailing list, please put me on it.”

B.H., Colorado

“Please send me your book covering all phases of foreskin restoration by stretching. I can’t believe that I may possibly have a foreskin again. I can’t wait to hear from you.”

J.L., Alabama

“I am a 73-year-old male who was circumcised five or six years ago because of an inflammation of the foreskin. Since this surgery, I have had problems. My family doctor and the surgeon he recommended to do the circumcision seem unable to appreciate my problems. Therefore, I have been, until recently, more or less resigned to living with the difficulties.

Recently, I became aware of UNCIRC and the possibility of foreskin restoration. Please send me your book on the recommended stretching program.”

H.L., Sparks, NV

“Just saw your article. I would appreciate if you would send me all the related information. At this point, I’m willing to try anything other than putting a knife to that part of my body for yet a second time. Perhaps your book will let me restore my body to the way it’s supposed to be.”

W.M., Spokane

“Thanks for the information. I am glad and comforted to learn that there are other men like me who are concerned about this issue. If women can pressure medical care insurance companies to pay for breast implants, restoration, reshaping, etc., we men should be able to have our foreskins restored.”

G.M., Maine

“Parents should not make the decision [to circumcise] for their sons. It should be a personal decision and against the law without personal

(continued)

### Men's Voices...

consent (at legal age). Society has been brainwashed or socially conditioned to make excuses for circumcision.

I think your program and methods are a Godsend for people like me, and I wish the information was more widely known and available for everyone who might want to change. I wish I could have started the program 20-30 years ago."

E.S., Wyoming

"It still amazes me today at how strongly I reacted, even at the age of 8, at learning that I had been circumcised. (I went swimming with two uncut boys in a creek and then asked my dad why they were different.) I felt so violated and so angry at this. I didn't know how to talk about it so I kept it to myself. Straight men and even gay men will not talk about it; they just laugh nervously or act embarrassed when the subject arises.

Fortunately, at the age of 30, I told my analyst about my feelings and I was so humiliated to even bring it up. He told me I had every right to feel the rage and he was very understanding. I think I feel much like children who are sexually abused. I feel violated and ashamed."

M.T., Alabama

"I was brought up in the suburbs of a midwestern city. My father was a graduate of Princeton, and my mother went to Wellesley. Among parents of their background in the 1930s, circumcision was the rule. But the practice was still not universal, as it became after World War II. I would estimate that about 80% of the boys I grew up with were circumcised like me, while 20% were intact.

In eighth grade I went to the same New England boarding school that my father attended. It was around this time in my life that I began to be sexually active and curious about sexual matters. One night as we were getting ready for bed, I asked my roommate why some penises were different from ours (he was also circumcised). He told me that everyone is born with a piece of skin covering the end of the penis but that most of us had ours cut off when we were babies.

*(continued)*

But, it is also time that circumcised males know that they can regain a delightful degree of the natural sensitivity of the glans, of the natural stimulation to the glans by the foreskin, and of the natural gliding function of the foreskin during sexual intercourse—to the pleasure of both the restored male and his partner. And so this book is written to speak openly and honestly about what has been lost through circumcision and what can be regained through foreskin restoration.

### To Provide Circumcised Men with a Dignified Voice

It was quite a revelation to me to discover just how many men feel as I do about being circumcised. But the biggest shock was to discover that the medical profession does not believe that we 'dissenters' exist in any significant number. Or, if we do exist, we are 'psychologically disturbed people who do not need to be taken seriously.' I had no idea, as I became acquainted with the issues, just how long some groups had been speaking out against routine infant male circumcision in this country nor how firmly the battle lines had been drawn.

I can and do accept the fact that there are differences of opinion on this or any other subject in human affairs. It does seem incredible to me, however, that the vast majority of the medical community can deny the existence of a legitimate contrary point of view and characterize those who work for it as fanatics and kooks. Early in the awakening phase of my involvement, I became aware that circumcised men who feel betrayed and violated by a culture and a profession which should have protected them would someday demand to be heard. It is my fervent hope that this book will speak with a dignified voice to say to this nation that, as circumcised men, we do care that you robbed us of our birthright: a whole body. And we do care that you are continuing to sexually mutilate the majority of males born in this nation. And, we are certainly *not* going to stop speaking out now that we have found our voice!

### To Bring the Hidden Pain of Infant Circumcision into the Open

Recently several well-known celebrities and entertainers have stepped forward to say that they are the victims of child abuse. Their purpose in coming forward is to raise this nation's awareness of a very old and hidden crime against children. Incest, molestation, and childhood rape of both sexes are only recently receiving nationwide attention. I would like to make two points here. The first is to note that the very first violation of a child's genitals in this nation is the indiscriminate surgical alteration of the infant male's penis. A child so violated will

never know nor regain a whole body. And it saddens me to note that not one of the celebrities who has stepped forward to champion the rights of children has so far acknowledged the fact that forced genital mutilation by whatever name is child abuse.

The other point that must be made is to answer those critics who question the wisdom of forcing individuals to deal with pain or wounds which they have apparently successfully buried. It's the old 'shouldn't-you-let-sleeping-dogs-lie?' syndrome. Whether the subject is incest or infant circumcision, there are those who wonder if it wouldn't be kinder to just keep still rather than risk awakening pain that otherwise might remain buried forever.

I would like to say clearly that it is not my intention to awaken pain in any circumcised male who is content with his circumcision. On the other hand, it is not possible to offer help and affirmation to those already in pain without acknowledging the validity of their pain and pointing out the shame and shortcomings of the system which has so needlessly caused that pain. In the process of extending such comfort and support, some men who have until now been oblivious to their feelings may be unexpectedly confronted and made aware of their pain. If that should happen, I can only trust that this book will give them hope and a sense of courage in the midst of their newly discovered pain. As a nation and as men we simply cannot continue to keep silent about the devastating effects of infant circumcision so that men already circumcised can remain blissfully unaware of their woundedness and won't be upset by what they hear.

### **To Prepare the Therapeutic Community for Things to Come**

The first therapists to see various stress disorders a few years ago had no other labels to apply to them than to call them some sort of borderline personality disorder. Then, as the numbers grew and job stress, burnout, and chronic fatigue became better known, we changed our views, our diagnoses, and our labels. In the case of strong negative feelings about one's circumcision, I was told by a urologist, as late as the winter of 1991, that men who seek the restoration of their foreskin are "at least borderline schizophrenics." When labeled like that, such men certainly do not need to be taken seriously.

My own experience with dozens of these men in person and hundreds by letter and telephone assure me that such a blanket diagnosis is not accurate. No doubt the first super-determined males who beat down the doors of the establishment to demand treatment presented the picture of a pretty animated and driven human being. But, as the numbers increase and the message spreads that it is okay

### **Men's Voices...**

To say that I was stunned and outraged by this revelation would be an understatement. I simply could not believe that this had happened to me, and I wished that I had been left intact, even though I would have been in the minority."

P.L., North Dakota

"For almost sixty years I have been very anti-circumcision minded and until recent years felt I was almost a minority of one. In the past few years, it has been a pleasure to learn that some doctors and nurses now agree with me.

I want to have restoration surgery, but will need to sell my wife on the idea. She thinks it's a silly idea, but I think that by using a little time and care, I will be able to bring her around.

In the meantime, I am going to make a special glans cap out of a soft pliable plastic. The cap will allow me to tape skin over the glans without getting any tape on the sensitive areas. Also, the cap will offer something solid to hold the stretched skin out and, in time, to stretch the skin beyond the end of the glans.

I hope that will work. However, I am still a candidate for restoration surgery. I am a retired metallurgist and am very good at making things. So in the meantime, I will make the cap using some casting methods I know about. I will let you know how well it works.

If I was single (which I don't want to be), I would be in the doctor's office tomorrow. So until my wife goes along with the idea of surgery, I will try stretching.

Keep up the good work and send me word from time to time on how the battle goes. Get to the mothers-to-be and brand new ones—that is where to stop circumcision. The fathers, in most cases, will go along with what their wives want to do."

E.R., New Mexico

"Please send me information on foreskin reconstruction. I am 31 years old. I have been trying to make my penis look 'normal' for 15 years. I am afraid that if I confronted any old M.D. with the problem, he'd lock me up."

S.A., California

## Men's Voices...

"Help. I was mutilated as a baby. I am considering restoration and would like to obtain the information you have on both surgical and non-surgical techniques."

M.B., New York City

"Briefly, and to the point, I had a circumcision when I was 19 years old by a Navy physician, because I had warts in that area. At first I was so sensitive that I could hardly approach a partner for sex. Over the years I could tell that the sensitivity was diminishing to the point that I was experiencing some difficulty. I am now 66 and feel that a reconstruction would be very helpful."

C.R., Virginia

"I would like information on the latest method of restoration used today. I am not gay. However, I am a victim of this unfair and cruel act of violence on a man's body. I have been emotionally scarred as well as physically. Today you hear a lot said about choice. What choice did I have? Or did any other boy for that matter?"

C.R., Massachusetts

"Please send me some information about foreskin restoration. I've phoned plastic surgeons within 70 miles, and even urologists, and have come up skinless. I really do feel like I've been robbed. Who in the heck took it upon themselves to rape and rob and mutilate me when I was less than a month old? It's not fair. It should have been my choice."

C.B., Indiana

"Please help my fantasy come true. Please send me any information you can on foreskin restoration. I'm not interested in surgery. My penis was cut once and I don't want anyone cutting it again."

G.P., Pennsylvania

"I'm a 35-year-old male who was butchered without my permission. And I've had difficulties throughout my life because of this. But I'm too shy to ask all the questions I'd like answered. For example, can it be redone? Can it be done secretly? (To avoid being made fun of.) My wife thinks I'm nuts."

D.Q., New Jersey

to care that your body was mutilated, I expect many more circumcised males to admit to themselves and to their wife, family, counselor, minister, rabbi, therapist, psychiatrist, etc., that they feel violated, cheated, and disfigured. As that happens, the community at large, and the therapeutic community in particular, must be ready to deal with their pain without judgment or labels which will do further damage. This book, then, is written in the hope that it will in some way alert the therapeutic community to be prepared to help wounded men whose pain and anger are only now beginning to be articulated.

## To Question the Psychological Impact of Infant Circumcision

As a psychologist, I cannot ignore the question of the possible psychological impact of infant trauma on the majority of the males in this nation for nearly 100 years. There are far more questions at this point than there are answers. But the few answers we do have are enough to set off warning signals. We know, for example, that abused children are apt to become abusers. We know that violence begets violence. And we know that a variety of childhood traumas result in rather predictable behavior and personality problems later in life.

In light of even this limited knowledge, to simply go on year after year inflicting excruciating trauma on a large segment of our infant male population and assume that there are no related consequences later in life is, in this age of enlightenment, sheer madness. And so, this book is written to raise at least some of the questions that must be asked and answered about the possible psychological consequences of routine infant circumcision.

## To Redefine Infant Circumcision as a Human Rights Issue

We've come a long way in our nation in our awareness of human rights, but we still have a long way to go. Historically, it was only a few short years ago that it was the right of one human being with a certain color skin to own another human being whose skin was a different color. That was the tradition, their right, and the law! Those who dared to oppose the system and the law were treated as criminals who were threatening the economy of a large segment of this nation.

Later, this struggle evolved into a fight for the civil rights of a people declared free but certainly not granted equal status. During this later era, research was published to support the idea that blacks were indeed inferior in certain measurable traits. It took a long time to convince some people that those findings were meaningless and beside the point. Inalienable human rights, not statistics, were the only valid measures upon which to settle such issues.

Now, we have another struggle with at least some similarities. Infant males are regularly strapped down and surgically altered for life. In many cases, the procedure is done because statistics are used to show that *as a group* males will have fewer cases of this or that if we routinely cut off a normal, healthy part of their body. Actually, the statistics for these claims are as biased, and the research as flawed, as those which were applied to blacks a few years ago. But statistics, valid or not, are beside the point. The real point is that a baby boy's genitals belong to him. No one has the right to alter or amputate any part of his genitals unless he was born with an obvious birth defect which requires radical and immediate treatment. And, using worldwide standards, such a condition would be so rare that it would be classified as an anomaly.

Somehow, we as circumcised males must make our message heard. Medical research using large-number samples cannot decide the infant circumcision issue. Numbers have no morals. Hitler used numbers. Southern preachers and teachers used numbers. The real issue is one of human rights. And so this book is written to confront those who are so encapsulated in their own disciplines that they believe that medical statistics are the only justification needed to disfigure and sexually diminish millions of males in this country every year.

### **To Place Infant Male Circumcision into a Worldwide Context**

Most Americans have no idea that we are the last nation on earth to hang onto the routine circumcision of our infant males. The rest of the English-speaking nations tried the experiment with us but gave it up years ago. We are a rather proud, naive, and self-satisfied nation. That is, we assume that we are pacesetters and that the other nations are either following our lead or soon will. It comes as rather a shock, then, to discover that we are the laughing stock of the other industrialized nations, that we are now the only nation on earth to circumcise the majority of her infant males for nonreligious reasons.

Nor do the other advanced nations have any of the inflated health problems that our medical community warns us will result if we do not circumcise our males. The rest of the world simply can't figure us out. We claim that infant circumcision protects from urinary tract infection (UTI) and venereal diseases and the AIDS virus. But, as a nation, we have some of the highest per capita epidemics and incidences of these problems, and the vast majority of our sexually active males are circumcised, which is supposed to mean better protected. This book is written, then, to tell the truth about infant circumcision. It doesn't save the male from anything that other less drastic preventive measures and treatments cannot do. And it robs the male of a great deal of sexual pleasure and responsiveness, especially as he ages. The rest of the world has stopped this nonsense, so should we!

### **Men's Voices...**

"I am very interested in your organization. I live in Kansas City and recently heard you interviewed on a local radio show. I have always wanted to somehow recapture the beauty of my foreskin, but I thought it was impossible, until I heard you! It was music to my ears, or should I say, music to my penis! Can you send me some kind of literature or information on your organization? I am very interested in the procedure also, which by the way, I have already begun. So far so good!"

M.N., Kansas City

"Up until I contacted you I didn't know if there was any way to repair at least some of the damage done by circumcision. It's great to know that I can restore the appearance of my penis as well as restore some sensitivity.

The stretching method seems ideal since it doesn't add to the scarring like surgery would. Also, the simplicity and lack of expense are major advantages.

Once again, thank you."

S.M., Buffalo

"I am seeking information on your group after reading an article in the newspaper. For the last several years I have consulted with various physicians in an attempt to have my foreskin restored. None of these physicians were sympathetic to my requests. From reading the article, the quotes lead me to believe that I have many of the same feelings about the loss of my foreskin since birth. Many times I have wished I could be intact."

R.P., Missouri

"I was very surprised to learn of the chances for restoration of the foreskin! I would very much like more information on this process, and I would like to know of the way one would go about seeking a physician who performs such techniques and medical miracles.

I would appreciate any information you could send me on this process, as I would very much like to start the process of foreskin restoration if it applies to me."

J.S., Illinois

### Men's Voices...

"I read about your group and the restoration interests we share. Please send me any information you have concerning the 'undoing' of what has been done to us and many men such as ourselves.

I think what you are doing is just fabulous, and I cannot tell you how warm I felt when I read about you in the local newspaper. We are not alone....

I must ask, though, that you send me any information available in the enclosed discreet, self-addressed envelope since I do not live alone, and I am not yet ready to speak of my wishes. I could not, unfortunately, add a stamp since you are in the U.S., but I assure you if your organization requires funds, and you send me information on where to send the funds, I will support you."

Q.P., Quebec

"Recently, I was contemplating the damage done to me early in life without my permission, and a friend suggested that I contact you. I understand that you have techniques to reverse this, and I would very much like to learn more. I eagerly await any information you can forward."

University Professor, Cambridge, MA

"Please send me information. I have long been interested in foreskin recovery, because all my life I've felt like I wasn't given a choice regarding a very personal subject. My father was uncircumcised and felt it would be 'cleaner' if his boys were. Ever since childhood I've wanted my foreskin back. It would be great if this is something I could do."

K.O., New Jersey

## To Inform Christians About the True Nature of Modern-Day Circumcision

Christianity, in all its many forms, represents the largest and most powerful religious force in America. And many dedicated Christians continue to incorporate infant male circumcision in their life style on the grounds that it must be wise if God at some point directed his children to do it. I have met very few Jews and even fewer Christians who know that the style of circumcision which is practiced both by Jews and the medical profession today bears little resemblance to the circumcision rite in biblical times. Almost no modern-day Christians know that the rabbis radicalized the circumcision procedure in approximately 140 A.D. Before that time it was a rather simple, symbolic procedure, quite different from the current practice which denudes and permanently alters the nature of the glans. Most Christians assume that God told Abraham to carry out a procedure something like that which a modern doctor or rabbi calls circumcision. It follows, therefore, that what they have the doctor do to their son is a circumcision like God told Abraham to do some 4,000 years ago. It isn't! And so, this book traces the history of circumcision and of foreskin restoration among the Jews from Abraham to the present so that those Christians who perpetuate medical circumcision in the name of God's wisdom and Christianity can be better informed.

## To Tell Both the Good News and the Bad News

As I laid out the organization for this book, I was reminded of the old vaudeville routine where one character comes up to the other and says, "Have I got news for you! Some of it good and some of it bad. Which do you want first—the good news or the bad news?"

Well, as a circumcised male, "Have I got news for you! Some of it good and some of it bad. Which do you want first?" You may think that I'm just making a little joke, but I'm not. If your primary purpose for reading this book is to learn the good news about what you can do to get back that which was taken from you, you may want to turn directly to Chapter 11 and begin reading the good news first. That way, you can take the bad news of circumcision's history and its consequences in small doses.

On the other hand, some of us are gluttons for punishment. Or, as we may prefer to think of ourselves, we are thorough and systematic thinkers who want the whole subject laid out in its historic and cultural context with no shortcuts. If you are this sort of reader, you'll want just to turn to Chapter 2 and begin reading at the beginning of the story as we consider the natural penis the way nature designed it before man redesigned it.

Either way you choose to read this book, my hope is that it meets a need for you and answers at least some of your questions and above all gives you a sense of not being alone.



## Parents' Voices...

"My wife and I were interviewing physicians for our expected child. One asked us, 'If it is a boy what about circumcision?' I came out with a pounding NO!! My wife said yes. So I had to tell her, talk with her, and inform her of what circumcision really is, and isn't. And tell her the impact mine had on me. She just assumed that since I was [circumcised], and since it is what others did to their sons, that ours would be circumcised. Needless to say, our son was born 03-06-92 and was left intact. A decision which I and my very caring wife are very proud of."

K.B., Washington

"At two weeks of age, our son Peter was circumcised at our pediatrician's office. I was invited to stay and watch. The next 20 minutes were to affect me for the rest of my life. The method used was the Gomco method. I had to witness Peter's screams while the foreskin on his penis was ripped way from the glans, crushed with a hemostat, pulled through the hole in the clamp, and finally severed with a scalpel. Peter became pale, gasped for breaths, and almost fainted. After it was over I could not talk, only hold my sobbing baby and bury my tears in his blankets because I knew I had been the one to decide on his circumcision. Had I known how barbaric and cruel it was, I would have never, never proceeded with this mutilation."

R.W., Provo, UT

"We waited until Mike was six days old as he was born early, and I demanded to be at the circumcision to comfort my baby. When I saw the doctor pick up the forceps, rip the foreskin away from the glans, and begin cutting the foreskin away with surgical scissors, I nearly went into shock. I'm not the least bit squeamish,

but I could not believe how he was mutilating my baby.

I couldn't believe the pain Mike went through during the operation. He had terrible problems with infection and scarring. I vowed that no other son of mine would ever have this happen to him, and I have been very vocal against circumcision for the last 18 years.

I had hoped it would not bother Mike as it had bothered me. Unfortunately, he often said to me from the time he was a young boy that he wished he had never been circumcised and would never do that to one of his own sons. I could only agree that it was a very barbaric and unnecessary procedure to perform on a human being. It has been one of my life's regrets that I could not undo the wrong that was done to him."

T.R., New Mexico

"I have always felt maternal guilt about Mark's circumcision. The obstetrician invited me to watch, which I did, and he assured me Mark was only screaming because of the restraints. I cry even today because my instinct at the time was to stop the doctor, but I didn't, because I couldn't explain myself."

A.N., Jamestown, NY

"Thank you so much for speaking with this sobbing mother last Saturday afternoon. My despair had reached an unmanageable point. God knows how I wish I could turn back the hands of time. I would never have had our infant son circumcised if I had been fully informed—no one would! But sadly I can't."

K.P., Canada

"I am the mother of a 17-month-old boy. Every time I change a diaper (and sometimes in between) I sorrowfully regret my ignorant

decision to let the doctor circumcise my newborn."

L.C., Reno, NV

"When I was born, I had the grave misfortune to be delivered by a doctor who convinced my mother to agree to my being circumcised. Since that day I have cursed all and sundry for the unwarranted and criminal mutilation of my penis. Perhaps I have overreacted but the loss of my foreskin has developed into a major psychological problem to such extent that I have had to undergo prolonged psychoanalysis, but the fixation is so firmly implanted in my mind that no amount of treatment has had any effect whatsoever. I would sell my soul to the Devil ten times over if I could get my foreskin back again. I have two sons who sport two magnificent long, loose foreskins, the sight of which turns me green with envy. I had to defend their foreskins and their right to retain them, almost with violence, such is the circumcision mania among doctors. God made men's penises with foreskins because they are supposed to have one and I want mine back. I have developed an absolute fixation in regard to foreskins in general, and my lack of one in particular, so please forgive me."

M.G., Father of 2 intact sons

"My five-month-old was circumcised at the hospital at just one day old. I thought it was an awful thing for such a tiny one to experience. I was with my son when the procedure was done, and it was the *most* barbaric thing I'd ever witnessed. I cried and cried and blamed myself for not going with my gut instinct ('No, no, no!'), even if it meant continuing to argue with my husband."

H.T., New Hampshire

## Women's Voices...

"I am a Registered Nurse. I hold a California EMT-1A rating (Emergency Medical Technician) and I hold a Bachelor of Arts degree in social psychology from a California state university. I am married and have three children, two of which are boys. As a surgical nurse I have witnessed many circumcisions.

The circumcised adult penis is less capable of responding to sexual stimulation than the natural penis. Additionally, the circumcised penis transmits a lesser grade of erotic pleasure to the male than does the natural penis. In my own personal experience I have found that it is easier to bring a man with a natural, intact penis to full erection and to maintain that erection during the course of an evening, and do so with less effort, than it is to accomplish the same objective with a man with a circumcised penis. Further, a natural penis provides me with a much more enjoyable rainbow of vaginal sensations, and provides a much more exciting object to fellate.

My impressions are not the basis for my conclusions. They merely add personal substantiation to academic observations."

D.V., R.N., Sacramento

"I first became aware of how naive American women were about circumcision during my freshman year at an American university. My roommate and I were dating the same guy, and I made a comment to her that I... 'dug Ron the most because he was uncircumcised, like my Danish boyfriends back home.' There ensued a heated debate because my roommate insisted that Ron was circumcised. It seems she had only seen his penis in the erect state, when the foreskin was quite naturally retracted, and assumed that, because the head of his penis was exposed, he must be circumcised! First of all, all normal uncircumcised penises have a foreskin that is capable of being completely retracted. Furthermore, I defy the average American male or female to distinguish between a circumcised penis and an uncircumcised one with the foreskin retracted,

either in a flaccid or erect state. There simply is no visual difference, except to an expert such as a physician (or myself!).

I find it a crime that so many American males are mutilated by circumcision. True, from an aesthetic standpoint the completely exposed head of the penis is a work of art, but, as I have already pointed out, the uncircumcised male can achieve the same look by merely retracting his foreskin.

At the same time, the uncircumcised penis has a 'cuteness' and personality of its own, and has much more potential in foreplay than the relatively inflexible circumcised penis. Moreover, the exposed head of the uncircumcised penis is infinitely more exquisitely sculptured than the circumcised one. For one thing, the head retains a smooth, satiny texture and an extreme sensitivity to touch throughout one's life. When a boy is circumcised at birth, by comparison, this sensitivity is soon lost. The skin of the glans becomes rough and the corona (rim) of the glans, unrestricted by the protective foreskin, flares out in what I believe is a most unattractive manner.

Another little-known fact is that the leading one inch or so of foreskin, which is the part ordinarily removed in circumcision, is richly endowed with erectile tissue, which responds to oral and manual stimulation in the same way as the female nipple.

The most common argument for circumcision is cleanliness. It's true that without regular washing, the foul-smelling smegma does form beneath the foreskin of the uncircumcised male. In this instance, European men could take a good lesson from American men. With American bathing habits (at least once every two days), smegma never becomes a problem."

Danish-American woman

"I have been in the United States nearly five years, since leaving my native Sweden. When I first started dating here, I was surprised, confused, shocked and disappointed because

almost all of the men here are circumcised. I have always regarded circumcision as barbaric and ugly. There are many American ways that I still do not understand, and perhaps I am still experiencing a culture shock, but a whole penis can't be that bad, can it?"

Swedish-American woman

"Even an uncircumcised man with bad technique is more satisfying to me than the best circumcised lover. You get that double motion action with an uncircumcised man. It's the best."

Woman caller on radio talk show

"I did not realize I even had smegma under my prepuce until the age of 45 when I was reading an article on female circumcision and examined myself. No one told me about it, and even as a nurse, I was unaware. In my research of women, I found I am not alone! One hundred percent of the several hundred women I've talked to have never retracted their foreskin to wash—and they have not had problems."

M.M., California

"I became obsessed with the idea that my boyfriend should be circumcised. We were very happy together, had much in common, and best of all, we were very compatible in bed. But I refused to get married until he was circumcised—and he gave in.

That little operation completely destroyed our life together. Before he had fabulous staying power, but after the operation he would have an orgasm in five minutes and leave me high and dry.

To make things worse, sex became very painful to me. Twice I had to see a doctor due to minor infections from the chaffing. Our beautiful sexual togetherness became a laborious nightmare of staying creams, lubricants, and frustrations.

He says he will never forgive me, and we no longer speak to each other...but I cannot forget what a stupid mistake I made which altered the life of a lovely person."

B.V., Miami

# 2

## The Natural Penis

*“So God created man in his own image, in the image of God he created him; male and female he created them....And God saw everything that he had made, and behold, it was very good.”*

**Gen. 1:27 & 31 RSV**

The American medical community has been waging war on the foreskin for most of this century. Their aim has been to eradicate the foreskin from every penis of every male born in this nation. The majority of American doctors have portrayed the foreskin as a mistake of nature and the curse of the male gender. In spite of this eradication campaign, the normal human male continues to arrive in this world with a healthy foreskin on his penis. No matter how many we cut off every year, they just keep coming! Since nature seems so stubborn about producing foreskins, perhaps we would be wise as an enlightened people to take a new look at the possibility that nature knows best and that there are, in fact, real advantages to leaving the penis intact.

The penis is often defined as the ‘male reproductive organ.’ Actually, in its sexual function, the penis is used a very limited number of times throughout any given individual’s life for procreation. At all other times, the penis provides sexual pleasure and fulfillment. In recent years, we have become far more comfortable as a culture with the idea of sex for enjoyment. It is in this particular delight, the enjoyment of sex, that the natural penis excels.

But how are American men, circumcised at birth and never allowed to experience their foreskin, to know about the pleasurable functions of the foreskin? And how are American women, acquainted almost exclusively with circumcised males, to know about the relative comfort of a penis which glides within its own sheath and does not dry up the natural lubricant her body provides? It is hoped that the information presented in this chapter will help the American reader to better understand the structure and the function of the natural penis.

### Men’s Voices...

“I’ve been restoring for almost two months and it’s hard to believe. But sex with my wife is getting better. I actually have more feeling. It’s great.”

35-year-old man

“After the coverage, I noticed that I was getting more, let’s say, ‘delicious’ feelings during sex with my wife.”

57-year-old man

“I was strapped down and forcefully circumcised at age 17. Neither parent had me circumcised. My grandmother on my mother’s side saw me masturbating (without my knowledge) when I was staying with her one summer. My grandmother got me to go to the doctor on the pretext of taking a physical for a job and she had me circumcised.

My foreskin was pulled forward and cut off. I had a partial erection due to the handling of my penis prior to and during the surgery. This along with the technique that the doctor used enabled me to retain most of the mucous membrane and frenulum. The doctor told me that I could be re-circumcised if I continued to masturbate. No anesthesia was used. The lady doctor (a friend of my grandmother) told my grandmother that the pain would be good punishment for masturbating. Even though I have a lot of skin left, it is not the same. I had a lot of overhang when erect

*(continued)*

## The Visible Anatomy of the Penis and the Foreskin

A great deal is known, overall, about the structure and the function of the human penis. There are many books, and even more chapters and articles, written to assist doctors and laymen alike to understand how the penis works. And yet, information on the structure and the function of the foreskin itself is noticeably absent. When illustrations of the human penis are presented in an American publication, it is often shown circumcised. Frequently, two illustrations are given—one with and one without—as though either condition were equally normal. The fact remains, however, that the human penis *naturally* has a foreskin (Figure 2-1).

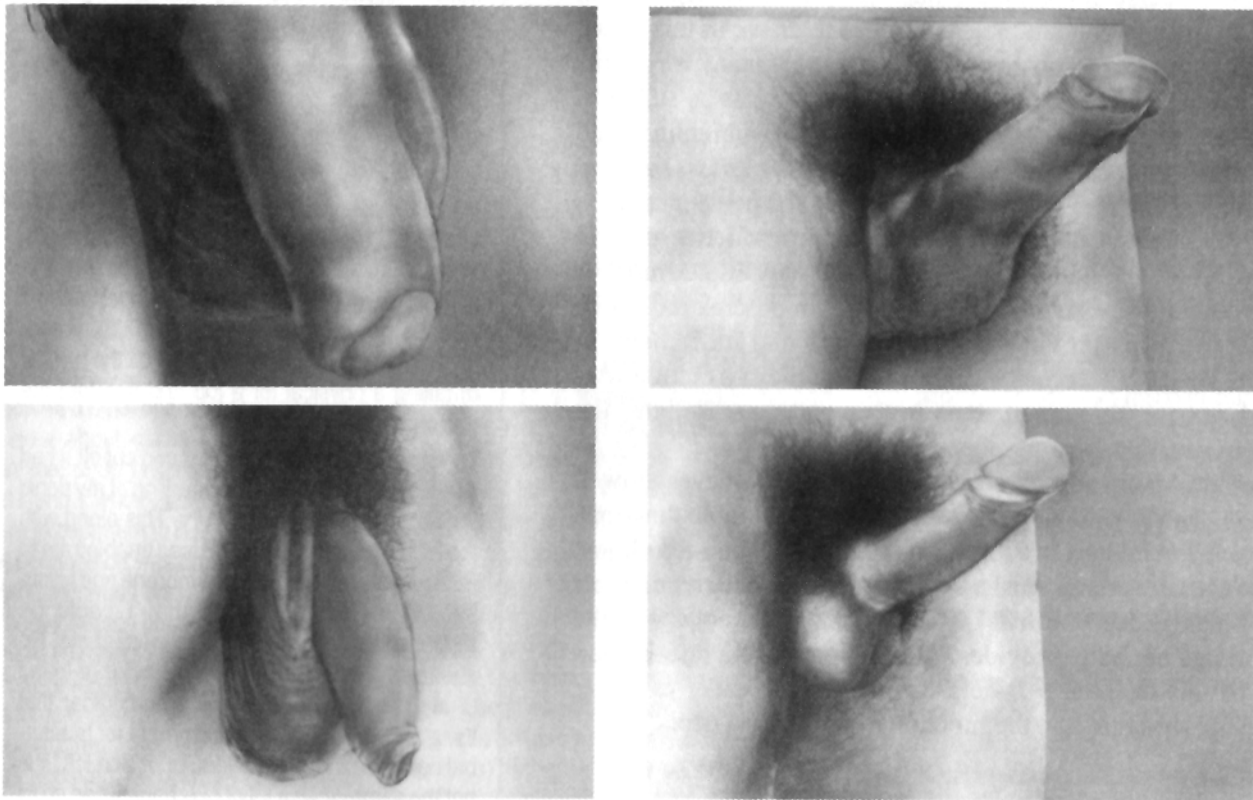

Two typical natural penises, shown flaccid (left) and erect (right). Note the variation of foreskin length in the flaccid state and the relaxed shaft skin in the erect state.

Figure 2-1 The natural penis shown flaccid and erect

Only recently has any research been done to discover the exact structural features of the foreskin. One fact, however, is already very clear—it is *not just extra skin!* Dr. John R. Taylor, a Canadian pathologist, presented his research findings on the structure and function of the foreskin at the Second International Symposium on Circumcision in San Francisco (1991). He noted in his presentation that various structures of the foreskin are so little known or understood that he had to give names to some of them before he could discuss their function. For instance, he has labeled the narrower band, which characteristically reduces the orifice of the foreskin near or beyond the tip of the glans, the “frenar band.” He coined this term because the band itself seems to originate, or to continue, from the frenulum. Dr. Taylor concludes,

The prepuce [foreskin] is much more complex than the ‘simple fold of skin’ described in the textbooks. Its inner, mucosal surface contains a tightly pleated zone, near the tip, rich in nerve endings...with a special sensory function (1).

This special sensory function of the foreskin is an integral part of the “pleasure dynamic” which we will discuss later in this chapter.

With its high density of nerve endings, its rich blood supply, its muscle fibers which give both skin tone and shape to its structure, and its predictable movement patterns, the foreskin is as unique as other ‘skin’ organs such as the scrotum or the eyelids. As for receptor nerves, the frenulum (the web of tissue on the underside of the penis which helps to hold the foreskin forward over the glans, particularly when the penis is flaccid) is exceedingly rich in nerve endings. Dr. Taylor noted that the foreskin, taken as a whole, is far more ‘naturally endowed’ with specialized nerve endings than is the glans. He concluded that, compared to the foreskin, the glans is a rather “dumb organ.” The fact that the male can live and father children without his foreskin does not in any way indicate that it is worthless or of no particular value. On the contrary, the amputation of the foreskin is a very specific loss to the male who is deprived of it (Figure 2-2).

## Foreskin Development and Early Function

The foreskin begins to develop in the male fetus at about eight weeks after conception (2). It develops as a part of the glans itself. At birth, only about 4% of male infants have a foreskin which has separated from the glans. This fact means, of course, that very few newborns have a retractable foreskin. For this reason, it is important that no one—doctor, parent, nurse, etc.—ever force the foreskin back off the glans before the normal developmental separation has occurred naturally. This separation usually takes place during the first few years of the child’s development. By the third year, 90% of young boys will have a fully retractable foreskin (3). It can, however, take up

## Men’s Voices...

and could orgasm by rubbing the tip of my foreskin.

Now, it is not as pleasurable, and I am limited in what I can do. When I was uncircumcised, I had a very long foreskin and there were many things that I could do that I cannot do now—plus, at least 50 to 60 percent of the intense sensation was lost with my foreskin.”

S.A., Phoenix

“...The enormity of the wrong done a baby by depriving him of his foreskin becomes clear if you talk with enough men whose foreskins are intact to realize how much the baby probably would have valued his foreskin—and why—had he been allowed to keep it.

...When you circumcise a baby, you are cutting off a part of his penis that you can cut off only because the person you’re cutting it off of can’t protect himself because he is a baby.”

John A. Erickson, Mississippi

“I was circumcised after the urologist advised it for a very minor irritation of the glans. I agreed, and now bitterly regret it. No information was provided. I feel violated and betrayed. The pleasure is reduced tremendously with the removal of the frenulum and the foreskin.

Uncircumcised sex is a much more complex and multi-faceted experience. For each stroke there are three component sensations all contributing harmoniously to the experience of the complete movement: (1) Retraction of the foreskin, with its sensitive tip, over the glans in the movement to a folded configuration; (2) The folded foreskin surmounting the corona and being stretched to full dimension; (3) The fully stretched foreskin pulling the frenum with the final stage of the stroke which in turn pulls the entire glans producing a pervasive and crowning experience of total sexual stimulation.

Steps one and two, although pleasurable and important in their own right, are subsidiary contributions and are ultimately overcome by the all-encompassing sensations produced by the frenulum. For the circumcised male, the status

(continued)

**Men's Voices...**

is: (1) Two of the three penile structures for sexual stimulation have been removed (frenulum and foreskin) or severely mutilated; (2) The one remaining structure which produces sexual stimulation, the glans, has been desensitized by being deprived of its requisite moisture covering; (3) The activity providing orgasm is reduced in the pleasure it affords; (4) The major dimension of intensity and sexual gratification is missing from orgasm."

W.P. (60 years old, circumcised at age 30),  
Miami

"I was circumcised in infancy, and from what I gathered, it only took a few minutes and it was considered a minor procedure. I am now 43 years old and I still suffer every day and night of my life, both physically and psychologically, because of that so-called minor procedure. I will always be my parents' son, but this body that I have belongs only to me and no one else. No one had my permission to circumcise me, and since there was absolutely no medical reason for doing it, it obviously was a clear violation of my basic human rights, and a clear violation of all medical ethics.

If anyone believes in circumcision, then let them be circumcised. But no one should have the right to force circumcision on anyone else. Shouldn't I have the right not to be circumcised if I don't want to be circumcised? Shouldn't I?

Since infant circumcision is a clear violation of human rights and also violates all medical ethics, shouldn't it therefore be outlawed? If we were truly a civilized country, it would be. Remember circumcision lasts a life time, and once done, it's done for life.

I'm constantly amazed how so few people know what the function of the foreskin is. It's a fantastic design, and because of this, not only are all male humans born with a foreskin, but all male animals of all species have foreskins as well. I don't hear anyone advocating circumcising animals! When are people going to realize that the same God who created the nose and ears and fingers, also created the penis, foreskin and all?

*(continued)*

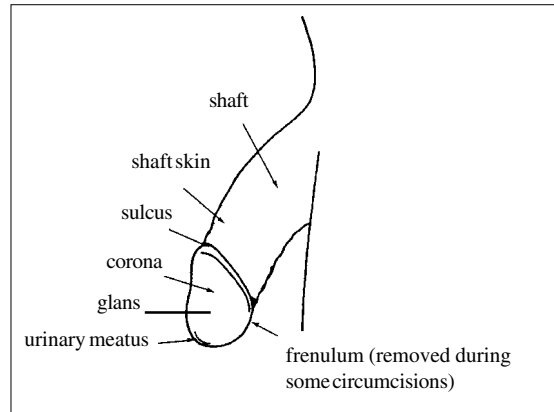

Flaccid circumcised adult penis

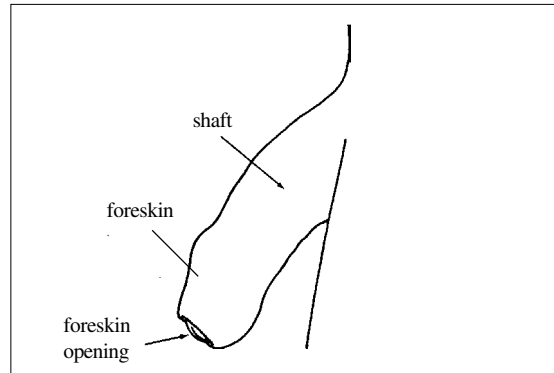

Flaccid uncircumcised adult penis

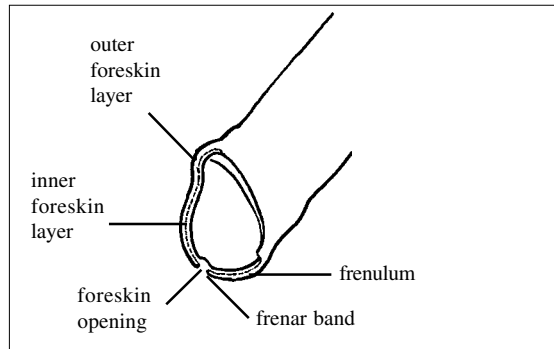

Hidden view showing foreskin layers of flaccid uncircumcised adult penis

Figure 2-2 Visible circumcised and uncircumcised penis anatomy

to 17 years before the last of the natural bonds (synechia) finally disappear. In infancy, no cleansing is required or recommended. Later, when some degree of retractability is observed, cleansing should include gently sliding the foreskin back only as far as it comfortably and naturally retracts and rinsing the penis with clear water. Harsh soaps are never recommended and are unnecessary. The glans is naturally an *internal* organ and should be treated as such.

There is little doubt that the foreskin functions to protect the tender opening (meatus) of the urethra during infancy. In more primitive cultures where infant nudity is common, little hands can freely smear feces and dirt on the penis. And, of course, sitting nude in the dirt puts the tip of the little penis right in the mud. In our culture, where infants are typically clothed, diapers regularly become soiled, and again the foreskin protects the meatus from contamination. As a matter of fact, meatal stenosis (inflammation or ulceration of the meatus) is rarely seen in uncircumcised infants but is quite common in those who are circumcised (4).

### **Sensual Responsiveness of the Natural Penis**

The sensual advantages of having a foreskin are rarely talked or written about in this country. This silence may be due to the fact that so few American males who write material dealing with human sexuality have an intact penis. If, however, we take into account the growing body of evidence worldwide, the sensual advantages of the intact penis are considerable.

The first advantage is, of course, the actual sensual sensations from the nerve endings within the foreskin itself. It is perhaps redundant to point out that these nerves can only provide their normal sensations when the foreskin has not been amputated. These delightful sensations are the major source of pleasure during the earlier, foreplay phase of sexual arousal. As sexual arousal continues, the inner lining of the foreskin and the glans itself become increasingly exposed and responsive to stimulation (Figure 2-3).

If the foreskin is left intact throughout the individual's life, the glans and the inner lining of the foreskin retain the texture, appearance, and nature of internal organs. The surface or outer layer of the glans itself remains mucous membrane and is very tender and transparent in appearance. In this natural state, the glans is capable of experiencing and conducting erogenous sensations not sensed by the more toughened glans of the circumcised penis.

### **Men's Voices...**

The purpose of the foreskin is so simple that anyone who gives this subject just half a thought can immediately see what the purpose is. Men have sex for only 1 or 2 percent of their lives. During the other 98 percent of the time, a man's penis is just dangling there. During this time, men don't want any feelings of any kind coming from their penises. Any feelings during this time are irritations and are obviously unwanted. But during sexual activity, men want their penises to be very sensitive. So what is the one way that we can have both maximum sensitivity and absolutely no irritations, even if the man is lying on a sandy nudist beach or just wearing stiff underwear? The answer is so obvious and so perfect that it's incorporated in all males, both men and animals alike. It's universal! We simply give the head of the penis a protective covering during the 98 percent of the time that it's not being used. And by being covered for the vast majority of time, the head of the penis is kept very sensitive, so when it's exposed during sexual activity, the man is given maximum pleasure. So there we have it! It's so simple!

Could some American doctors be giving wrong advice regarding infant circumcision because it's a big business in the United States? What's the old saying about...if the shoe fits?"

G.D., Arizona

"...I am writing to you now with a very clear message—and one that I feel is not stressed enough. The greatest disadvantage of circumcision, in my view, is the awful loss of sensitivity and function when the foreskin is removed. You will recall that I was deprived of my foreskin when I was 26; I had ample experience in the sexual area, and I was quite happy (delirious, in fact) with what pleasure I could experience—beginning with foreplay and continuing—as an intact male. After my circumcision, that pleasure was utterly gone. Let me put it this way: On a scale of 10, the uncircumcised penis experiences pleasure that is at least 11 or 12; the circumcised penis is lucky to get to 3. Really—and I mean this in all seriousness—if American men who were circumcised at birth could know the deprivation of pleasure that they would experience, they

(continued)

**Men's Voices...**

would storm the hospitals and not permit their sons to undergo this unnecessary loss. But, how can they know this? You have to be circumcised as an adult, as I was, to realize what a terrible loss of pleasure results from this cruel operation."

R.T., Denver

"It's okay to be the only intact boy in the group. Virtually all the boys I grew up with were circumcised. I can state from personal experience that circumcising a boy so that he will look like other boys is not a valid justification.

Educating an intact son about the advantages of the foreskin helps develop and reinforce a good total self-image. I have shared with our son age-appropriate information on circumcision so that he would feel good about himself even though all his friends are circumcised. At four, when he noticed that other boys looked different, my wife and I said that the operation hurt very much and that sometimes things went wrong so that the baby was injured. We also said that we felt boys looked better with their penises intact, and that there were important nerves in that part of the body that he would need later on. The positive self-image that resulted from these talks rubbed off on at least one of his friends. When, at six or seven, our son showed him how the foreskin slips back and forth, his friend came up with the highest kid's accolade: 'It's gross and cool.' As our son approached puberty, I discussed the positive sexual advantages of the foreskin.

He is now a well-adjusted 15-year-old who feels having or not having a foreskin is no big deal. Clearly, being in a minority doesn't bother him and he feels good about himself."

H.M., Illinois

"Like many men my age (29), I was involuntarily circumcised at birth. My father was uncircumcised and wanted me left intact, too. My mother went along with the thinking of the time that I should be circumcised for hygienic reasons. Unfortunately, she won out. As a child, it was difficult to understand why my penis had a scar on it and looked different than my father's. Even now when I see an uncircumcised man in the locker room, I think how fortunate he is to have an intact

*(continued)*

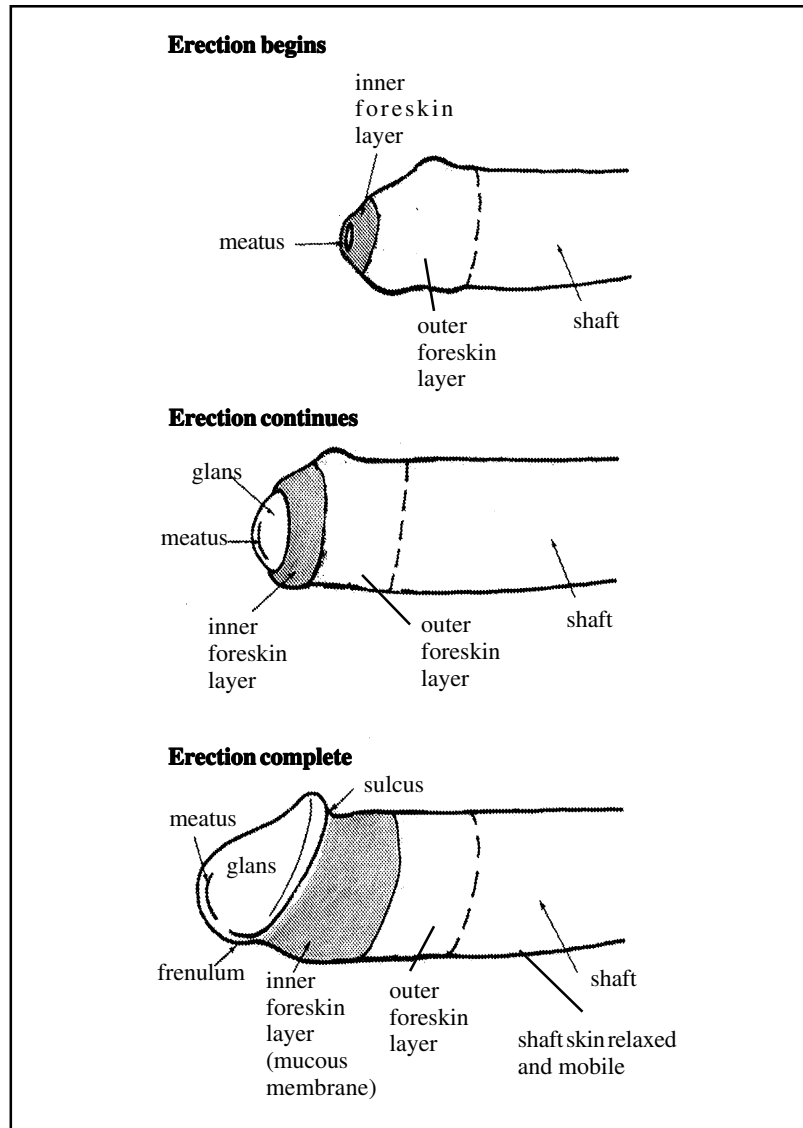

Figure 2-3 Erection process of uncircumcised (natural) penis

**The Pleasure Dynamic: A Sexual Function**

Another advantage of the functioning foreskin has to do with the natural stimulation of the glans. In any good sex manual, the male will be warned not to attempt to stimulate the female clitoris directly. Rather, he will be instructed to learn to move the hood of the clitoris back and forth over the clitoral head (glans). This action, typically, provides the most satisfying stimulation possible for the female. The same holds true for the intact male. The foreskin itself provides the natural glans with the most comfortable and satisfying stimulation possible until the male is well into the later phases of sexual arousal.



The mobile skin sheath of the natural penis allows the foreskin to repeatedly slide back and forth (or unfold and fold again) over the glans during foreplay and intercourse. Dr. Thomas J. Ritter, in his book, *SAY NO TO CIRCUMCISION!*, has coined the phrase, “the pleasure dynamic,” to describe the mutual stimulation between the expanding-contracting of the foreskin itself and the glans as the foreskin slides back and forth over the glans. Dr. Ritter notes:

The psychic and physiological response of the male to this cyclic unit of penile stimulation is exceedingly intense and pleasurable. If one’s partner is participating in this maneuver, the pleasure is immeasurably increased. The dynamic, cyclical penile stimulation during intercourse is illustrated in Figure [2-4] (5).

### The Gliding Mechanism During Intercourse

Finally, we should discuss a very valuable ‘mechanical’ function of the foreskin. This function provides more enjoyable intercourse for *both* partners. During sexual arousal, the female normally produces natural lubrication which allows for comfortable entry of the penis into the vagina. During intercourse, the natural penis, to a greater or lesser degree, thrusts in and out of its own skin sheath, until nearer the point of ejaculation when the glans expands further. This skin sheath acts as a kind of ‘gliding mechanism’ for the penis inside the vagina. As a result, the natural moisture provided by the female remains by and large within the vagina and is not dried up by the repeated thrusting of the male. This condition allows the female to be far more comfortable and to enjoy prolonged intercourse. Furthermore, since the foreskin hugs and stimulates the glans so perfectly, the male is more naturally stimulated throughout each phase of sexual arousal.

### Prevalent American Attitudes Toward the Natural Penis

Most Americans reading this chapter about the natural penis are bound to be saying to themselves, “Yes, but what about cleanliness, what about diseases, and what about needing a circumcision later if it is not done in infancy?” “Don’t foreskins usually cause serious problems?” Such questions are almost inevitable in this country, and we will discuss many of our national myths about the foreskin and circumcision in later chapters. And we will look at some of the ill-founded prejudice which intact males can face in our culture. Let me just say here that the men in the rest of the Western world are found to be as healthy as the men in this country and that they view their foreskin as a source of sexual pleasure and not as a threat to their health. The many supposed evils associated with the foreskin which we have been taught to expect are indeed rare in those advanced countries which allow their

### Men’s Voices...

penis. If I had had a choice, I would still have my foreskin today.”

W.E., Wisconsin

“Marcia Millman, in her review of ‘The Beauty Myth’ by Naomi Wolf (May 12), comments on the strange bodily mutilations that many women go through, especially breast surgery. She asks us to imagine what it would be like if men were regularly having surgery done on their genitals and comments that ‘it’s difficult to imagine men mutilating themselves this way to conform to some image of desirability.’

I couldn’t help but wonder if Millman has ever heard of circumcision. As recently as 15 years ago, 85 percent of boys born in the United States were circumcised, and even today more male infants in the United States are circumcised than not.

I find it a little preposterous that when an adult woman makes a free choice to undergo cosmetic surgery she becomes a victim of anti-woman tyranny, but when an infant boy is strapped down to have a physically and psychologically sensitive part of his body sliced away without consent or anesthesia (the medical establishment believes it is too dangerous to anesthetize infants) it is ignored or dismissed as a ‘cultural’ or ‘health’ issue.”

Letter to the Editor,  
*San Francisco Chronicle*, June 30, 1981

“I am an uncircumcised 25-year-old (because my mother was Rh negative). I think that being intact has made sex more pleasurable. Of course, I have nothing to compare it to, but women I have been with have indicated that I seem more sensitive than circumcised men.”

P.G., Florida

“Circumcision advocates most often try to justify the surgery by saying: it decreases the risk of urinary tract infections (UTIs); it decreases the risk of sexually transmitted diseases (STDs); it eliminates the risk of penile cancer; it makes the penis cleaner.

Well, let’s give them the benefit of the doubt and assume that these claims are correct (and let’s disregard the pain, the complications, and the diminished sexual function caused by circumci-

(continued)

## Men's Voices...

sion). Then it naturally follows that these assumed benefits can also be bestowed on women through routine infant genital surgery. After all, women's genitals are overlaid with skin folds and are moist—perfect for UTIs and STDs. Cancer of the vulva is much more common than rarely seen cancer of the intact penis. And female personal genital hygiene is surely more complicated than in the male. Is infant genital amputation then the answer for UTIs, STDs, cancer, and cleanliness in the female? Of course not. It is unthinkable!

Then why...why do we accept it for males? Physicians and parents must search their own hearts for answers. The next generation of little boy babies is listening...and wondering...and hoping. How will we respond? What will we do to them? They don't want restraint boards, betadine, surgical drapes, crushing clamps, surgical scissors, excruciating pain...They just want to be hugged and cuddled and suckled and loved—just like little girl babies. Just like anybody would want. Can't we do that for boy babies? Can't we just do that for them?"

K.H., Illinois

"The thing I wanted to put in writing is the use of the foreskin for vaginal entry. It has been my experience that the foreskin can be used for easy entry into the vagina without any artificial lubricant, or without any perceivable amount of natural lubrication. At the moment of entry, my wife is able to draw my foreskin forward just beyond the glans of my erect penis. She then manually guides my penis to the lips of her vulva, and as I press the lips of my foreskin inward toward the vagina, she releases me and I slide in as my foreskin retracts, with minimal friction.

I want to go on record as saying everything you have said about having a foreskin is true. The part of foreplay and sexual intercourse that sends me into greatest ecstasy is the moment when my penis begins to swell, and my foreskin is slowly retracted for the first time. The feeling is hard to put into words."

A.N., California

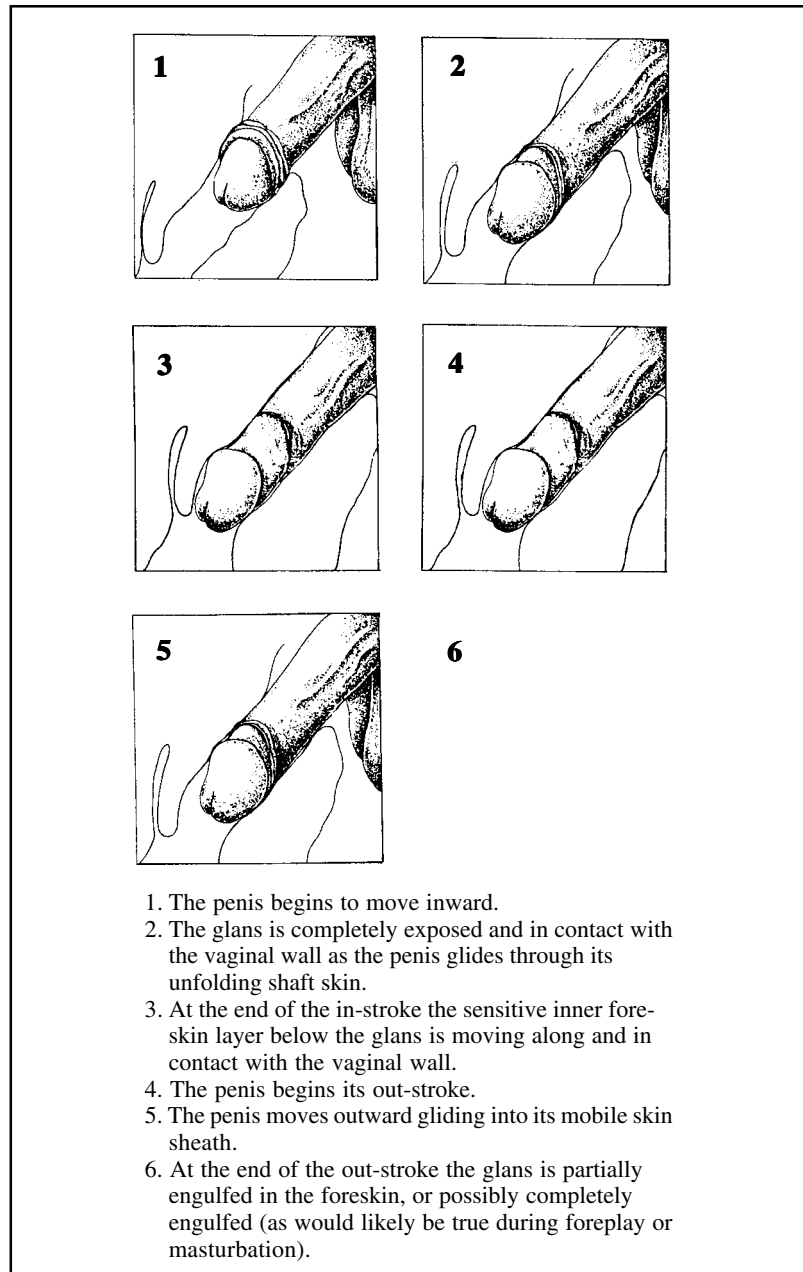

Figure 2-4 Uncircumcised penis pleasure dynamics during intercourse (Adapted from Berkeley (6))

males to keep and enjoy their birthright: a whole body complete with its foreskin.

We have looked briefly at the unique feature of the natural penis—its foreskin. In the next chapter we will look at the circumcised penis and its unique features.

# 3

## The Circumcised American Penis

*“When I was six or seven I found out that scars meant you had been hurt and then realized my penis was.”*

**J.T., Houston**

Prior to the turn of this century, circumcision was recommended as the appropriate treatment for a host of diseases and socially unacceptable behaviors—particularly masturbation. And for the next 100 years, routine infant male circumcision gained popularity as a preventive measure for an array of physical and social maladies. The estimated rates of infant male circumcision in the United States show a steady increase from 1870 to the mid-1980s (Figure 3-1).

The information in Figure 3-1 tells us not only the estimated percentage of males who were circumcised at birth during each decade in this country but also something about the male population in

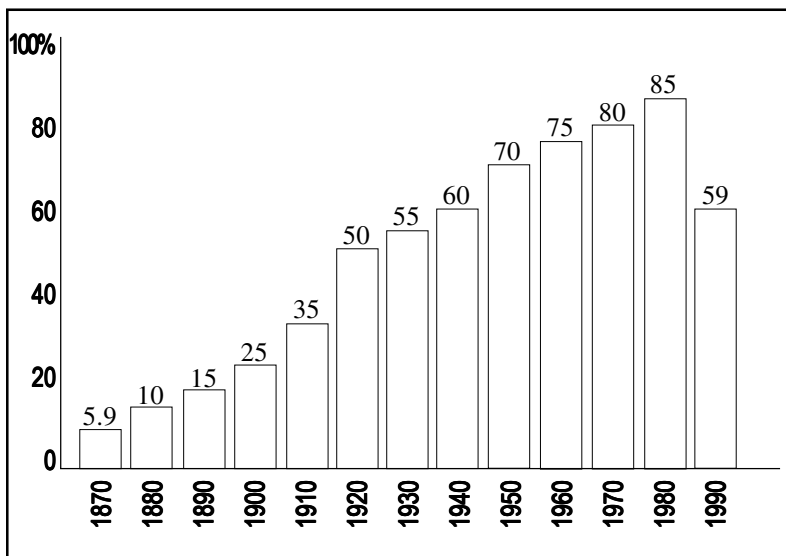

Figure 3-1 U.S. circumcision rate (Adapted from Wallerstein (1))

### Men's Voices...

“I am a 47-year-old secondary mathematics teacher in Oklahoma. Although I wasn't circumcised at birth, I did decide to get circumcised at age 28, mainly because I had heard that it was much easier to 'keep clean' when a male is circumcised. Although it was a little easier to keep fresh and clean after I was circumcised, I found that the negatives of circumcision far outweighed the minor benefit of a slight improvement in hygiene. I wound up being very sorry that I had become circumcised because of a major loss of sexual enjoyment after the circumcision. I found that the loss of my foreskin led to a 'drying out' of the head of my penis and a resulting loss of sensitivity in the head of my penis. But the biggest factor in the loss of sexual enjoyment was that I no longer had a foreskin to massage the head of the penis during intercourse and masturbation. I no longer had skin moving tightly back and forth across the head of my penis, which had provided a great deal of pleasure previously. I still consider my decision to get circumcised to be one of the biggest mistakes in my life.”

R.P., Tulsa

“I was circumcised at age 20 because I felt odd and different from friends. Only afterward did I

*(continued)*

## Men's Voices...

realize how lucky I was to have been 'natural.' I have regretted my decision ever since. I know now that you lose the sensitivity and the versatility of having a foreskin.

I've only recently heard of the restoration possibility and was very excited to say the least! I've always felt jealous and sad when I've seen another man with his foreskin. Fortunately the doctor who performed the circumcision left enough skin to allow for an erection so I can grab the skin with both hands and pull the skin over my glans with a good tug.

I just started to tape the skin over the glans two days ago and have difficulty getting the tape just so without being too tight or loose. I have a concern about the tape being too tight when I get an erection in my sleep. I want to try to keep it taped 24 hours a day. I use paper surgical tape which holds very well for me. I'm trying to think of things to use to put over my glans, stretch the skin over that, and tape it into place, still leaving a hole to urinate through. I've also heard of various weights applied as the stretching

(continued)

America today. A man who was 50 years old in 1990 belongs to an age group in which approximately 60% of his contemporaries are circumcised. And a man who was 20 years old in 1990 will have approximately 80% of his contemporaries circumcised. By these simple calculations, the males with the largest percentage of circumcised contemporaries were only 10 years of age in 1990. These data indicate that the era with the highest percentage of sexually active circumcised males in America is yet to come. The crest of that wave will not hit us until the dawn of the 21st century! Furthermore, if we take into account the rising birthrate during these same years, the increasing *number* of sexually active circumcised males in this country is in the tens of millions. Add to these simple statistics the fact that America has a worldwide reputation as a circumcising nation, and it seems fair to conclude that the 'American penis' is indeed a circumcised penis (Figure 3-2).

Typically, American males make few demands of their penis. First, as little boys growing up in 'bigger-is-better' America, the hope is that it will be big! Then, as sexually active males, the hope is that sexual activity will always feel good to them and that their penis will always achieve and maintain a firm erection, at least firm enough and for long enough to deliver its payload. Actually, this final demand is the *only* concern of the American medical community relative to the sexual function of the penis. After all, if a male can father children and learn some means by which to bring his partner to orgasm, what more does he want?

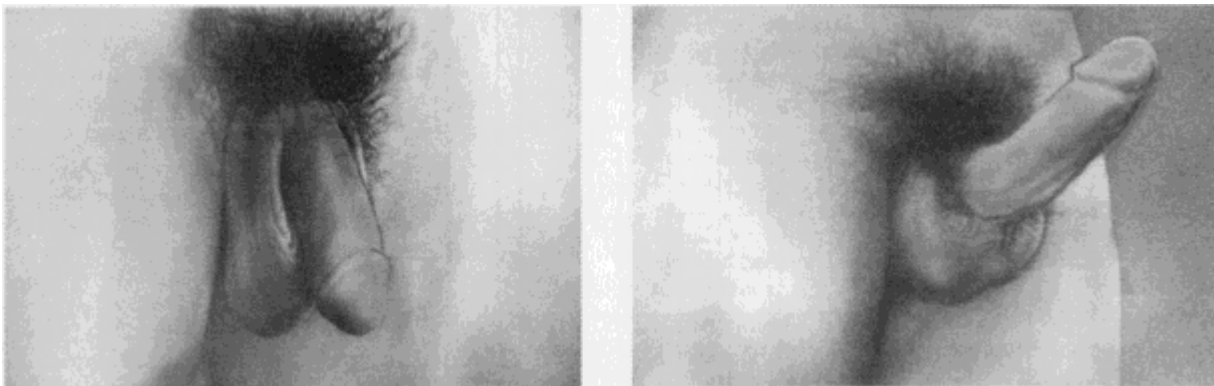

A typical circumcised penis, shown flaccid (left) and erect (right). Note that there is no slack skin on the flaccid penis shaft and the shaft skin is stretched tight in an erect state.

Figure 3-2 The circumcised penis shown flaccid and erect

Since routine infant circumcision has been in vogue in America for most of this century, there are relatively few males with an intact penis whereby valid comparisons can be made. The majority of men in America have grown up in social situations where most, if not all, of their male friends and classmates were also circumcised. Even in such an informal atmosphere as the school locker room, American males have had little or no opportunity to make the most casual comparisons with an intact penis. Further, our national taboo against talking about the penis makes it almost certain that most American men will know nothing about the functions or sensations of the foreskin.

Even now, when the national circumcision rate has been dropping for nearly a decade and the pros and cons of routine circumcision are more publicly debated than at any time this century, the general lack of valid information among circumcised boys is apparent. In 1992, Dr. Norman M. Schlossberger, et al., reported a recent study in which the knowledge and attitudes of adolescent boys (age 11-14 years) about circumcision were explored. When asked to verbally identify their own circumcision status, only 66% of the circumcised boys were able to give an accurate report; however, when shown drawings of a circumcised and an uncircumcised penis, 93% were able to accurately identify their own status. Incidentally, the researchers note:

The uncircumcised boys appeared to have more *prior* knowledge about circumcision in general and greater awareness of their own status than did the circumcised boys....The uncircumcised boys...perceived themselves as being in the minority (2).

It would seem that perceiving one's status as 'minority' heightens both perception and awareness.

The findings reported by Dr. Schlossberger and his associates are consistent with the information gathered at UNCIRC and other circumcision and restoration information centers. Clearly, many circumcised males in our culture grow up never being informed by any significant adult—parent, close relative, doctor, etc.—that they were circumcised, why they were circumcised, nor given any opportunity to ask questions relative to their circumcision. The most frequent response to some of the more specific questions in the various questionnaires is 'Don't know' or 'Never discussed.' In fact, many men indicate that they have never before spoken to *anyone* about their circumcision or their feelings about being circumcised. Many of these men respond that they think they were circumcised for reasons of hygiene. They often go on to indicate that they, too, believe that the circumcised penis is somehow cleaner. But, cultural bias aside, what actually happens to the penis when the foreskin is amputated? (Figure 3-3).

### Men's Voices...

progresses. I hope to hear other mens' ideas, methods, results, and how long it took to achieve their goals.

Looking forward to your added expertise and valued information."

P.R., Fresno

"Throughout my entire life, I've always felt frustrated, never sexually fulfilled, always feeling as if something were missing. Masturbating has never seemed to be anything more than a light release of tension. It never has felt 'so good' like it's supposed to. Something was missing, and I knew it. I had no way of knowing what was missing. I always assumed that all I was missing was a female partner. Once I find a lover, all my troubles will be over, I would imagine. I will be in heaven, and my previous lifetime of lonely frustration will be behind me.

In my early twenties, I found that this was not the case. I found myself alone with a girl friend who was equally curious about sex. One thing led to another, and we ended up engaging in (non-coital) sex. She sure enjoyed her part of it...and that was before she achieved orgasm. The stimulation of her clitoris was obviously affecting her entire body, not just her clitoris. When she came, there wasn't any question about the intensity of her experience. In fact, she used words like awestruck to describe how she felt when the overwhelming feeling swept over her entire body. In the meantime, the excitement of it all left me aching to have my turn. But what a let down! I could hardly feel anything! Where were the fireworks? Why wasn't I going through the ceiling like she had? It was more thrilling than doing it with my own fist...but not much.

None of this bothered me greatly at the time. I was relieved that my curiosity was satisfied—to a degree—and I figured that it wasn't that fulfilling because of our inexperience. It could only get better. Besides, if we had intercourse that would surely be the solution...But now I know that intercourse would not have been the answer. The reason I couldn't feel anything is because I

(continued)

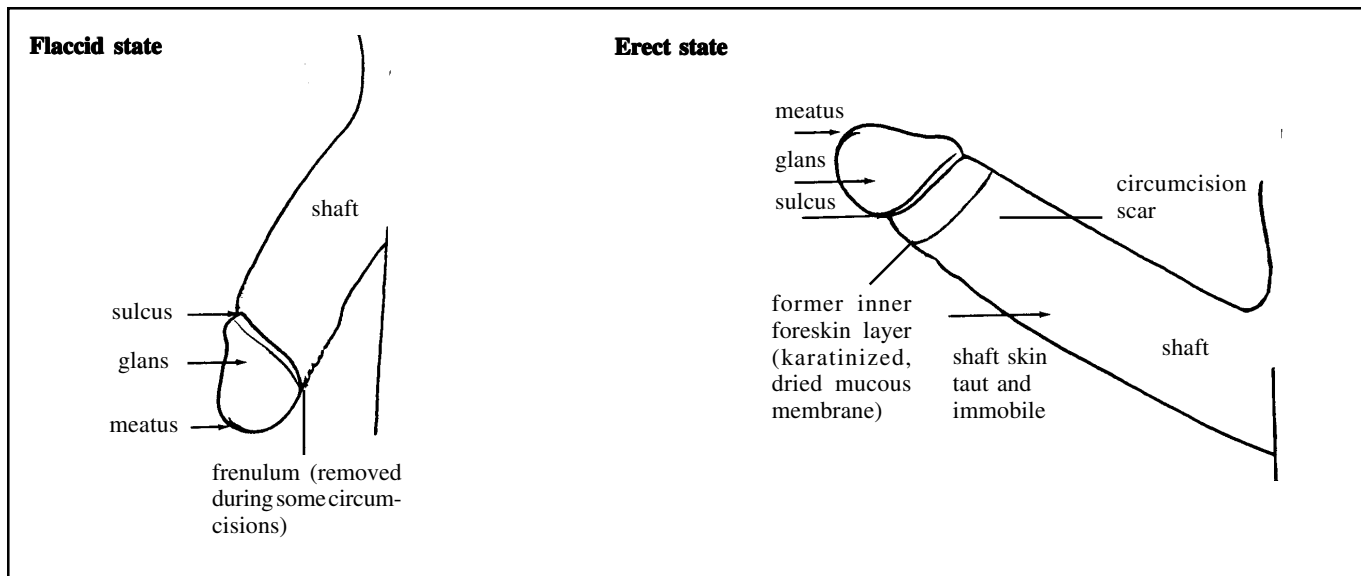

Figure 3-3 Erection process of circumcised penis

### Men's Voices...

was robbed of the most sensitive part of my penis on day one...

I am reminded at this point of a conversation I had with my friend Todd when we were fifteen or sixteen. He broke the news to me that women enjoy sex more than men do. Sure, that's a disappointing thing to hear...but now I realize that it's true—at least in America."

B.Y. (circumcised as infant), Arkansas

"Some of the problems that I have experienced because of circumcision are probably the most common. The main one is a decrease in the sensitivity of the glans, which other men have told me of, too. The main problem with this is that I have difficulty in maintaining an erection without almost constant manipulation. This has also contributed to some mild psychological problems, which compound. I am not impotent, and a doctor has told me that the size of my penis (about three inches above average), along with the decrease in sensitivity due to circumcision, have combined to cause this problem.

Another problem is that I feel some resentment towards my parents because they took it upon

*(continued)*

### The Glans Becomes an External Organ

Circumcision transforms the glans from an internal organ to an external one. And the effects on the glans are dramatic. At birth, only about 4% of males have a fully retractable foreskin (3). Typically, the foreskin and the glans are bonded together and are in fact one organ. Their natural separation takes anywhere from a few months after birth to 17 years to complete. Therefore, in nearly all cases, in order for an infant to be circumcised, his foreskin must first be stripped off his glans. This procedure has been described as "skinning the infant penis alive!" (4). The result to the glans of this stripping procedure is that the natural mucous covering is traumatized and becomes to some degree scarified (Figure 3-4).

Not only does the entire raw surface of the typical infant glans become scarified, in all cases, the outer surface of the glans will undergo a process known as keratinization. Dr. Thomas Ritter explains:

The skin...possesses a coating layer of keratin. The greater the exposure of the skin to abrasion, pressure, and use, the thicker the layer of keratin. Skin is in constant contact with the environment. It is also subject to great temperature variations. It becomes thick when it is subject to rough treatment....Mucous membrane normally possesses no keratin layer....It is softer, usually constantly moist, and its thermal environment usually approaches or is at body temperature.

The unkeratinized mucous membrane of the normal glans penis can select its environmental contacts. The normal glans can be an internal or an external organ. The dry, keratinized circumcised glans has no such choice; it is irreparably locked into a condition of constant exposure to a variety of unusual, non-intended, and in a sense, unnatural environmental agents.

The glans is no longer an internal organ and there is no way of protecting it from environmental objects that it was never meant to contact (for example, urine, feces, dry and wet diapers, and clothing). The epithelium (surface) of the glans eventually becomes dry, dull, leathery, brownish, and keratinized, taking on the character of skin rather than mucous membrane (5).

Even the most casual inspection of the glans of the typical male circumcised at birth will reveal a rough, grainy, ridged, and often pitted surface. This surface is very different from the smooth, glossy, and more ‘transparent’ appearance of the glans which has been allowed to disengage naturally from its foreskin sheath and then has remained protected within its folds.

### Loss of Sensual Sensitivity

The most common effect of infant circumcision on the glans is a general lack of sensitivity. As the glans becomes toughened it is simply not capable of the more subtle and sensual sensations experienced by the natural glans. This condition is further aggravated by aging and the accumulated years of exposure and rubbing against clothing. The result is a truly desensitized glans. This process continues throughout the individual’s lifetime, and many older circumcised males complain that having intercourse with their circumcised glans is like having intercourse with their elbow.

One male, who was circumcised as a sexually active adult, was asked to compare his sensations during intercourse before and after his circumcision. His reply was that, on a scale of 1-10, intercourse with his foreskin was at least an 11 or 12—without it a 3! (6). There seems little doubt that sensual sensitivity is greatly reduced by circumcision and that the reduction is even more pronounced when the circumcision is done at birth so that scarification is added to keratinization. Add to these facts the loss of the nerve endings which were in both the foreskin and the frenulum, and the overall loss of sensation is dramatic.

### Problems Unique to the Circumcised Penis

**Meatal Stenosis.** From the moment of surgery, the circumcised penis is at higher risk for meatal stenosis—inflammation or ulceration of the meatus (urinary opening). Since we are a culture which diapers its young, feces and urine are held close to the body and the penis of the infant male. Anyone who has seen the normal penis of a newborn will be struck by the apparent excess of skin which typically bunches and protrudes beyond the glans itself. This natural protective cover and protruding tube of skin keeps foreign matter well away from the tender opening of the urethra. On rare occasion, a male infant is born without a foreskin. When this happens, it is recorded in his records as a birth defect (aposthia). Yet, when a male is born with a normal penis, complete with foreskin, a vast number of medical professionals in America will seek to give him the birth defect he missed out on as soon

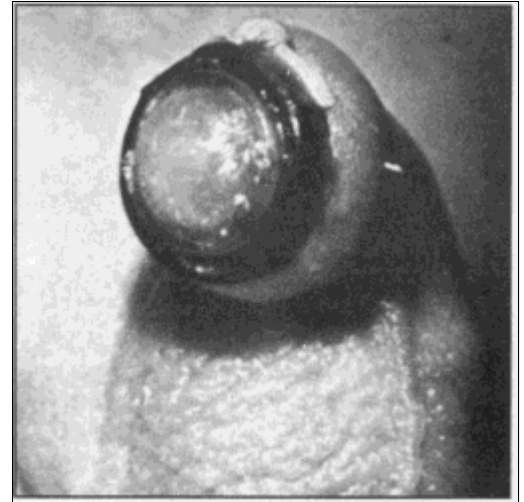

Figure 3-4 Raw and reddened glans after infant circumcision (Plastibell)

### Men’s Voices...

themselves to have a part of my body cut off, without my consent, without any thought that I just might want that part of my body intact.

When I was eight or nine, I realized that I had been circumcised, and even though I don’t recall the exact circumstance, I am sure the discovery was one of confusion and curiosity as to why I had been cut. I do remember that I envied one of my friends because he insisted that he had more to have fun with. Although this may be somewhat amusing now, to a young boy just discovering the pleasures of his body, I am sure that it was a low blow discovering that I had been denied something.

Although I have learned to live with being cut, there have been times when I have wished that my foreskin was intact. I have even gone so far as to use condoms, cut and placed on myself (a tedious and time-consuming task) to simulate a foreskin—so strong is the desire to know what all of my original parts would feel like. Yes, I think that I would consider foreskin restoration, if the procedure could be done successfully, and affordably, although I would feel some trepida-

*(continued)*

## Men's Voices...

tion about the operation. After all, they (doctors) messed it up once...

Forgive the wordiness of this letter, but it is not everyday that a person can air his grievances about such a topic as the barbarism of circumcision."

NOCIRC newsletter

"I am 44 years old and was circumcised at birth because the doctor told my parents that the foreskin would close and I would not be able to urinate. Later my mother told me that most 'nice' boys were circumcised. When our first son was born in 1972 we encountered great pressure from the hospital staff when we refused to have him circumcised. We were treated like weirdos and told that circumcision was universally done. Our second son was born a few years later, and though we encountered no pressure at that time, we were presented the consent forms as a matter of routine.

While I bear no resentment toward my parents for having me circumcised, I have always felt cheated and wonder what it would be like to have a foreskin. I am glad that informed physicians of today no longer regard amputation of the foreskin as necessary to good health."

T.W., Connecticut

"When I was eight, we took a long vacation for three months and stayed at the home of one of my mother's sisters. While there, I shared a double bed with one of my boy cousins.

My cousin was not circumcised, and it was then we both learned something. He wondered why I always went around with my foreskin pulled back. I asked him what he meant, and he showed by retracting his foreskin that he had a knob, too. From that, we put two and two together and figured out that all boys were born with foreskins and some of them, like myself, had lost them through circumcision.

At that time, we both agreed that it was better not being circumcised. He said he never wanted to be circumcised, and I felt that I had been robbed of something that was rightfully mine.

*(continued)*

after his birth as possible. When the natural protection of the foreskin is removed by circumcision, feces and urine are allowed to come into contact with the very tender meatus of the urethra which often results in an inflammation rarely, if ever, seen in uncircumcised infants. It is estimated that about 1/3 of circumcised infants have some degree of meatal ulceration. In the worst cases, surgery is needed to correct the problem (7). How strange, circumcision which was performed to prevent health problems actually creates at least one of its own—in addition to the usual risks and possible complications of the surgical procedure itself.

**Hypersensitivity.** The effects of the scarified covering of the glans are not the same for every circumcised male. For a small number of men, circumcised at birth, the result is hypersensitivity. This is not a pleasant or sensual sensitivity. It is rather an irritating and often painful condition of the glans. Some of these men write to say that they have tried everything they can think of to prevent their glans from rubbing against clothing or bedding. Some have wrapped their penis with gauze or Saran Wrap or have worn condoms during the daytime to protect the glans from friction. Others have tried lotions or powders to ease the hypersensitivity.

## Reduced Sexual Functions of the Circumcised Penis

The sexual functioning of the American circumcised penis is also impaired. I stress the term, American, here because in this country we have typically adopted a tight, severe style of circumcision. If members of the American medical profession were true to their declaration that they simply want to assure cleanliness and avoid phimosis, they could take care to perform circumcisions with sufficient shaft skin for the developing male to grow into. Rather, most American males have been left with little or no mobile skin on the shaft of their circumcised penis. In fact, too little skin for comfortable erections and intercourse is the most common complaint we hear from males circumcised in this country. This lack of skin to enhance foreplay and intercourse results in a very different sexual experience for both the male and his female partner.

**Americans as Lovers.** American males do not have a particularly good reputation as lovers. They have been described as lacking skill at foreplay, apt to move too quickly to orgasm, and often as too rough. Obviously, having a natural penis with its foreskin intact would not solve all of these complaints in every case. Having a natural penis would, however, go a long way toward remedying a good many of these problems.

**Foreplay is Often One-Sided.** Foreplay is the very essence of being a good lover. To be satisfying, foreplay must be equally



enjoyable for both partners. This requires that the male enjoy being touched and fondled as much as his female counterpart. In Chapter 2, under the heading, “the pleasure dynamic,” we discussed the mutual stimulation which occurs between the expanding-contracting of the foreskin itself and the glans as the foreskin slides back and forth over the glans (Figure 2-4) (8). If, however, the male’s penis has been robbed of its ability to create, detect, and respond to these natural sensations which would typically be produced by the more delicate caresses of foreplay, who can blame him for wanting to cut to the chase? Nothing else feels particularly good or stimulating.

**Missing Stimulation.** Not only during foreplay but throughout the earlier phases of intercourse, the intact penis provides its own natural means of stimulation as the foreskin glides back and forth over the glans. Many circumcised men find it hard to believe that the covering and uncovering of the glans by the foreskin during intercourse would be especially stimulating. As noted above, we discussed the “pleasure dynamic” in Chapter 2 (Figure 2-4). Dr. Ritter goes on to say:

Circumcision destroys the natural, slick, facile method of penile stimulation. Ironically, many circumcised men do not know what they’re missing. In fact, some who have...read about it can’t appreciate it. How can intermittent covering of the glans be enjoyable, they ask? Possibly, this puzzlement results from the diminished sensitivity of the circumcised penis. But circumcised men, who have restored their foreskin, are thrilled by this ‘new’ form of stimulation (9).

**Missing Motion.** We live in a day when sex manuals are a very common sight on bookstore shelves. In every one of them, the male will be encouraged not only to develop foreplay techniques but to learn to delay his own orgasm until both he and his partner are assured mutual satisfaction. For most males, this means learning to endure prolonged sexual thrusting without having an orgasm too quickly. How ironic, we encourage the male to learn to thrust longer but provide him with a penis which dries up the natural female lubrication with every thrust. Each time the circumcised male withdraws from the vagina, his penis brings out into the air some of the natural lubrication. And each time his penis re-enters, the vagina is a little drier than it was for the preceding thrust. No doubt there are some females who produce a seemingly unlimited supply of lubricant. For the majority, however, the natural lubrication will be dried up by prolonged thrusting with an American penis. Often the American male is then accused of not being sexually exciting enough, or skilled enough, or of being too rough.

American males themselves are often both uninformed and concerned about the fact that they don’t seem to be able to ‘do it right.’ Dr. James H. Gilbaugh, Jr., writes a monthly column in MEN’S HEALTH under the title; *ask ‘Dr. Private Parts.’* Late in 1990 he responded to the following letter:

### Men’s Voices...

For almost 60 years I have envied those men who never lost their foreskins. I have always wished I could grow a new one.

During the 1940s, I had to battle the doctors and my parents to let my two sons keep their foreskins. I felt it was their choice to be made later. When they were 12, I told them that I didn’t believe in circumcision and why—I offered to have them circumcised, but they agreed with me and voted to keep their foreskins. Now I still have two uncircumcised sons plus three uncircumcised grandsons.”

B.C., El Paso

“I am a 24-year-old male in my second marriage. My first marriage fell apart because of what didn’t happen in the bedroom. I was constantly on edge because of sexual frustration. Now, my second marriage is slumping in the bedroom. I have little trouble with erections or ejaculations. My problems are lack of intensity, numbness during and after intercourse, and self-consciousness about the appearance of my circumcised penis.”

A.M., Missouri

“Circumcision was virtually unthought of in Wales where I was born in 1922. Since about the time of my entry into the R.A.F. in 1942, I have been reasonably heterosexually active all my life. In 1959, while attending U.C.L.A. as a graduate student, I became friends with a group of Jewish interns and faculty at the University Medical Facility. During this time I contracted a skin disorder around my glans penis. The area became swollen and sore. My foreskin would not retract and sexual activity was difficult. Reporting this to the U.C.L.A. Medical Facility and my friends, I found out that I needed an operation that required the stretching or cutting of the prepuce and subsequent antibiotic treatment. No mention was made of circumcision. An operation was performed, and I recovered clear consciousness to discover that I had been circumcised. Very obviously sincere and intense explanation by my medical friends of the health

(continued)

## Men's Voices...

necessity for the action smothered my irate objections. So it was that I was permanently deprived, and the humorists deflated my complaints.

My newly naked, sensitive glans penis was protected from irritation with cotton and such. Slowly the area lost its sensitivity, and as it did, I realized I had lost something rather vital. Stimuli that had previously aroused ecstasy had relatively little effect. There was a short period of depression, but acceptance of the situation developed, as it had to do. The acute sensitivity never returned, something rather precious to a sensual hedonist had been lost forever. So, it is that I hope you will do what you can to discourage circumcision. My experience and reading indicates that the operation is not only medically unnecessary in the great majority of cases, but also that circumcision destroys a very joyful aspect of the human experience for both males and females."

J.T., Los Angeles

"I have been angry about the subject of infant circumcision for some time. It started when I realized that it was one of the factors in me taking so long to climax with my sexual partner. How could a country that calls itself civilized do such a horrible thing to its little boys? My thought is that parents have no right to consent to unnecessary surgical procedures on their children anyway. It's rape and should be prohibited by law in all 50 states."

S.R., Ohio

"I'm a 42-year-old man who was circumcised in infancy. I still suffer both day and night because of what was done to me. Until the day that I die, I'll probably be in constant discomfort. To me, being circumcised is like wearing a sock with a hole in the end of it and having my big toe protruding from it. I'm constantly trying to pull my sock over my toe. It isn't painful, but it's constantly irritating. (Try it.) As long as anyone (male or female) is forced into circumcision, 'civil rights' is just an empty phrase to me."

D.P., Colorado

*Dear Dr. Gilbaugh:*

*I am 23 and very sexually active in college. However, recently I have been 'hurting' my girlfriend during sex because I am always so dry. I never have secretions except when I ejaculate. What's wrong and can it be fixed?*

The doctor's reply:

Your 'dryness' problem can't be fixed—but that's only because nothing's broken....

It is the female of the species who, when sexually aroused, produces natural lubricating fluids. Sometimes this fails to occur, and yes—attempting intercourse when 'dry' can be extremely painful for those involved.

The best solution is to get a tube of water-soluble lubricating jelly...and use it (10).

Dr. Gilbaugh's statement that "nothing's broken" is, in all likelihood, only partially true. While it is true that it is the female of the species who provides the natural lubricating fluids for intercourse, the *intact* male does indeed furnish the equally natural 'gliding mechanism' discussed in Chapter 2. The young man who wrote the letter cited above is almost certainly a typical circumcised American male. In which case, he is working with equipment which nature did not design! Had his foreskin been left in place, he would be thrusting in and out of his own skin sheath throughout most of the earlier stages of intercourse, and his female partner would have needed only to provide enough lubrication for his initial entry. A very practical result of circumcision, then, for many American couples is the need to resort to artificial lubricants.

## Trouble-Free Maintenance

It must be acknowledged that the circumcised penis is virtually 'maintenance free.' That is, the circumcised penis needs no special attention to hygiene beyond the regular washing of the entire body. It is also true that the circumcised penis has little or no unique body odor. Some men and women alike consider this fact a good thing. Others, however, consider normal body odors, male as well as female, a desirable facet of human sexuality.

The idea that males should be surgically altered as infants because men and boys really can't be trusted with the care of their own penis is a common theme even in medical literature. In discussing penile cancer, Dr. Sherman Silber states, "Cancer of the penis generally occurs when there has been carelessness in taking care of one's foreskin, but a man can be just about as unclean as he likes if he has been circumcised" (11). Dr. S.I. McMillen takes exception to the American Academy of Pediatrics' 1975 recommendation that penile hygiene be discussed with parents if they elect to leave their son intact. Dr. McMillen, who favors infant circumcision, states, "This recommendation...is based on the erroneous assumption that if you

tell a boy to wash something, he will do it” (12). As a male, I am insulted by the notion that a healthy, functioning part of my body was amputated because it was feared that I could not learn, nor be trusted, to care for it and that I would probably like, rather, to be dirty.

After all of my research and investigation, I can find only one irrefutable advantage in owning an American penis. It can be said with absolute certainty that you can’t get your missing foreskin caught in your zipper! Although, it must be pointed out that plenty of circumcised males have managed to get other bits of the male anatomy entangled while ‘crossing swords’ with a zipper. As a male circumcised in infancy, I can’t help but wonder what my penis would have looked like and what additional sensations I would have experienced had my penis been left alone. One thing is clear from the numbers—if my foreskin had been left in place, it would most likely still be there. The data show that males who arrive at adulthood with their foreskin intact rarely elect to have it removed unless they are convinced that a medical problem makes it necessary.

### **Circumcision in Older Children and Adults**

Unfortunately, in this country, the information, data, and tactics used to convince an intact male or his parents that a problem severe enough to require surgery exists are not always used truthfully. America is not generally a safe place for a foreskin regardless of the intact male’s age. Most American doctors are neither trained nor skilled in the less radical treatment procedures used in other countries. As a result, they often recommend circumcision in situations which could easily be treated by less severe measures. I recently met a man in his early 40s who had been circumcised at age 21, shortly after his marriage. It seems he had contracted an infection and went to his doctor for treatment. Circumcision was recommended and, during the next week, performed. Some years later he went to another doctor and, in the course of the examination, told the second doctor about his earlier infection and his circumcision. The second doctor rather casually said, “I guess the other treatments just didn’t work for you.” The man’s response—too late—was, “What other treatments?”

We seem to be in a real ‘catch 22’ in this country. We simply do not have enough doctors who have a foreskin of their own so that they can appreciate the value of what circumcision amputates. We’re in the position, therefore, of needing doctors who will allow infants to retain what they, themselves, have lost and cannot evaluate firsthand. Somehow those of us in this country who care about the right of the individual to a whole body are going to have to convince parents and doctors alike that only the individual himself has the right to choose whether or not to keep his foreskin. To do so, we will need to combat a host of accepted myths about the intact penis and infant circumcision. In the next two chapters, we’ll consider a number of these myths.

### **Men’s Voices...**

“In this part of the country they are still doing it in spite of recent insurance changes. All new things start in the West and move eastward, so maybe the anti-circumcision movement will slowly take hold here. Let’s hope so! I was routinely circumcised as an infant and have become increasingly envious of those who are natural and dying to know what it would be like ‘the other way.’ I definitely believe males should have a choice. As you say, they can always have it done when they are old enough to know, if they so choose. I doubt if many would make such a choice. The more I read about it, the more senseless it becomes. Tonsillectomies have left the fad market years ago. (I had one of those too!)”

W.T., Pennsylvania

“This subject is unfortunately for me a lifetime nightmare. It all started the day I was born, March 7, 1951, at Tampa General Hospital in Tampa, Florida—a time when routine genital mutilations were performed. Ever since I can remember, I always knew something was wrong with my penis. I guess it was 1959 or 1960 when I realized what was wrong. My best friend’s oldest brother was intact, and it was the first time I ever saw a complete penis. I knew then what was wrong with mine. I remember feeling this sick sense of loss, and continue to until this day in 1990, and will probably go to my grave with it. My Creator made me in his or her own special way. I still believe my Creator knew much more what he was doing when he created me than any other man or woman ever would or could. But for me, someone made a huge mistake. I will never be able to understand how any person (doctor or parent) can think they have the right to cut any body parts off of another person without the person’s, or should I say, victim’s consent. I have also learned that these perverts who perform this heinous crime on infant children could care less what their victims feel or think. I guess that’s the price I pay for being born in America, the land of the free. Free to have everything except all my body parts. Now don’t get me wrong. I have no problem with circumcision for adults who feel they need their genitals mutilated.”

M.H., Oregon

## Voices From Abroad...

"I recently read an article about your book, *The Joy of Uncircumcising*, in our national newspaper. I feel very excited about the possibility of recreating what I have lost which presently causes me a lot of stress."

R.D., England

"If men in the States where the circumcised man is in the majority feel bad about their shorn state, imagine how it feels in a country where the vast majority is now left intact. Not only is the circumcised man aware of his mutilation but he is also always conscious that he's the odd man out, a freak if you like, and the reaction of women to whom it is equally an oddity takes on a special significance. The reaction, 'Poor thing, was there something wrong with it?', is one of the most galling experiences a man can have! I wish you all success in your campaign against America's inconceivable yen for this often distressing and wholly unnecessary procedure. What horrifies Europeans like myself and damages America's standing as a civilized country are those tales of military recruits being hounded into the circumcision wards by the military establishment."

J.D., England

"I confess that when I ordered your book, I did so with a hint of amusement as I thought that it was probably a case of a 'nut case' writing a book for 'nut cases.' I apologize to you and those who are interested in what you have to say, as I myself am now one of those 'nut cases.' By the time I had finished reading your book, it had convinced me that mutilations of this nature are unjust."

T.S., England

"It is just four days since I last wrote to tell you how I was getting on with taping. Since then something totally magical, wonderful, and unexpected has happened. I feel reborn! On Thursday, I realized that my genitals were completely comfortable for the very first time in my life. I could never tolerate loose clothing of any sort, and yet now I was wearing boxer shorts with the tape on and I felt fabulous! I underwent every emotion known to man. I lay sobbing in my wife's arms half the night. I knew there was no going back and I have to go on to full foreskin recovery. Now I want to tell everyone what has happened. Already the glans is softening around the corona and feels more delicate and moist."

I am angry with the medical profession about what they have done to me and countless other men. They have sent me out into the world with an

essential part of my penis missing and have told me it was not necessary and I was better off without it. It has taken me 50 years to find out the truth. It is only thanks to you and the brave pioneers in the U.S. that I know it. I don't know how to thank you for what you are doing."

H.R., England

"As I started to read through your book, I went through a wide range of emotions. As my understanding of the issue increased, so did my anger and sense of violation. But it was all a healing process and felt good at the same time. Here at last I actually had contact with someone, another man, who knew exactly what I felt like, and I realized that all the feelings I'd had since childhood were fully justified. The *Men's Voices* section voiced everything I had felt, too, and brought back some emotions and incidences that I had forgotten. It was such a good, warm feeling realizing how many of us there are—it was like discovering a new family!"

M.W., England

"If only we had been given the choice to agree or disagree with the irreversible 'whims' of the medical profession we would never have needed your voice to communicate the darkest and most hidden grief that exists in the millions of us who were mutilated at birth. A fact that the majority of us are unable to admit to ourselves, for the fear of accepting the blatant truth."

James Williams, England

"The results of the restoration were fantastic! As soon as my glans remained protected, I recovered gradually the sensibility and moisture of my glans; in six months the skin of the glans became thinner and dark pink—before it was gray with brown stains."

In July, my foreskin covered three-quarters of the glans when I was completely flaccid. Since January, I have always been covered—even if I move or wash my penis. In every condition, I can pull my foreskin back on my glans, which in a very natural way remains completely covered; the opening is now reduced to a point.

You must imagine how fantastic it is for me to feel normal! I hated the feeling of being a freak among my friends who weren't cut. Sexually, the benefits are wonderful too—my wife and I don't have any more problems with lubrication during intercourse."

T.D., France

"Our long discussion on the phone helped me greatly, although, of course, I'm still very angry, bitter, jealous and frightened; I feel mutilated,

less-than-male. The phrase 'And the men began to scream' rang so strongly true with me—I'm still 'screaming' and continue to encounter new information and consider new perspectives. I fear healing is going to take a very long time."

R.J., Australia

"I am of mature age and have resented my circumcision all my life. I confronted my mother as an 18-year-old and was mortified that she had had it done as being 'best for me.' When asked, 'In which way?', she could not give any answer."

J.P., Australia

"The doctors never seem to ask the obvious, sentient question: 'Maybe he'd like to keep his foreskin?' It's just another angle on man's inhumanity to men and another sinister indication of savagery still lurking just below the surface."

G.S., Australia

"Routine circumcision was so endemic among my generation—I was born in 1960—that it wasn't until high school that I discovered that boys weren't born that way. My informant, a friend, had a reputation as a prankster, and my initial reaction was one of emphatic disbelief. I mean the idea sounded so ludicrous, so totally without purpose."

We adjourned to the school library where a couple of grisly photographs in an encyclopedia proved his case. I was devastated. I felt violated, mutilated. And angry. More so when I read the accompanying text. Even to a naive schoolboy the arguments for circumcision just didn't add up. They still don't today."

Prior to reading your book I'd wondered—not infrequently—if perhaps there wasn't something wrong with me. After all, a preoccupation with something I'd lost forever (or so I thought) didn't seem to me to be a healthy attitude to life. Nor did the rage I felt—and still feel—at the blatant gratuitousness of the procedure. Fuelling the suspicions I harboured regarding my emotional health was the fact that no one else seemed to be suffering similarly, or even complaining. Your book provides incontrovertible proof that I'm not alone, and, better still, I'm not neurotic! Thank you very much."

P.A., Australia

"Your book, while reassuring normality, could be very depressing for circumcised men if no remedy were offered. The rational, objective argument you present could not fail to persuade any reader of the necessity of the foreskin."

N.R., Australia

# 4

## Common American Myths About the Penis and Infant Circumcision

*“The human male is cursed with a super abundance of foreskin over the penis. Circumcision remedies the fault by removing the excess of foreskin.”*

**S.I. McMillen, M.D.**

If the American penis is circumcised, it is because the twentieth century has been ‘the 100-year reign’ of routine infant circumcision in this country. During this century, only a handful of doctors and parents have questioned or opposed the practice. With such near-universal acceptance, many beliefs about the penis and infant circumcision have come to be accepted without question. Many of these beliefs have become, in fact, national myths. That is, they are simply believed to be true and are often repeated

without any demand that they be reconsidered or demonstrated to be true.

Myths only survive in a culture when at least some authority figures give them credence and benefit from them. Circumcision myths survive in America in part because a very large segment of the medical community in this country continue to repeat them and to operate according to them. In this chapter we will take a critical look at some of the more common circumcision myths and how the medical profession perpetuates them.

---

**Myth:** *The foreskin is simply redundant and purposeless skin which extends beyond the actual penis itself—a mistake of nature.*

Dr. Sherman Silber presents the myth like this,

The foreskin is essentially just an extension of the outer penial skin that is redundant and extends well beyond the actual tip of the penis. It is this extra skin that is removed during a circumcision (1).

A.A. Lewis, together with Dr. Eli Bauman and Dr. Fred Klein, states categorically,

The foreskin has no sexual significance for the healthily formed male. It neither impedes nor increases his coital pleasure. With erection, the foreskin naturally rolls back to

uncover the head of the penis and, from then on, plays *absolutely no part in any sexual activity*. The head usually has extreme erogenous sensitivity, but *the foreskin has none*. It is as useful as one’s appendix and, like the appendix, can sometimes be troublesome enough to need surgery (2). (Emphasis JB)

Dr. S.I. McMillen has even less flattering things to say about the foreskin,

The human male is *cursed* with a superabundance of foreskin over the penis. Circumcision...*remedies the fault* by removing the excess of foreskin (3). (Emphasis JB)

As I have said earlier in this book, America is not a very safe place for foreskins.

---

**Fact:** *The foreskin is not just skin—extra or redundant.*

How strange, we’ve been routinely removing foreskins for nearly a century without ever knowing exactly what we’re removing. At the Second International Symposium

on Circumcision, held in San Francisco, May, 1991, Dr. John Taylor of Canada reported several unique structural features of the foreskin not found in the skin elsewhere on the penis (4). Whatever else may be discov-

**NOTE: During the last few years, the research presented in this chapter has been greatly expanded in several instances. For further information on more current research, see Circumcision Information and Resource Pages [www.cirp.org](http://www.cirp.org)**

ered about the structure and the function of the foreskin, it is certainly not just an extension of the shaft skin!

Circumcision destroys a foreskin in a matter of minutes. By comparison, it takes nature anywhere from 9 prenatal months to 17 years to develop a fully functioning organ. The myth that the foreskin has no unique structure or function and is simply too trivial to matter colors the consideration of every other issue involved in routine circumcision. Whenever issues are raised to argue that routine circumcision is unnecessary for the vast majority of males who undergo the surgery or that circumcision is 'overkill' for most treatable conditions, someone is bound to counter, "So what?" "What real difference does it make, the foreskin is only a little scrap of tissue anyway!" As Cecil Adams unabashedly declared in his syndicated column, *The Straight Dope*, "...from an anatomical standpoint, God's little mudguard is basically ordinary skin" (5).

---

**Myth: *The intact penis is very difficult to care for and to keep clean.***

The American Academy of Pediatrics Task Force Report on Circumcision (1975) is one of the most enlightened documents on circumcision to be published in this country. It states,

A program of education to continuing good personal hygiene would offer all the advantages of routine circumcision without the attendant surgical risk. Therefore, circumcision of the male neonate cannot be considered an essential component of adequate total health care (6).

Unfortunately, this same report contains rhetoric elsewhere which implies that the intact penis presents unique and laborious hygiene problems: "If circumcision is not elected, *the necessity for lifelong penile hygiene* should be discussed with the parents" (7). (Emphasis JB)

---

**Fact: *The intact infant penis requires no special care other than the same lifelong hygiene which is a necessity for every accessible part of the human body.***

Dr. Paul Fleiss gives a simple directive: "Leave the penis of the newborn infant alone" (10). Various doctors suggest various ages at which special attention to penile

This myth is particularly difficult to overcome in a culture which has so few foreskins to allow valid comparisons.

As to the rather cavalier statements by Lewis and his medical colleagues relative to the foreskin's lack of sexual significance and function, it can only be assumed that none of the three gentlemen spoke from personal experience. And, since their book was published in 1978, it is almost certain that no research data on the foreskin was available to them at that time.

Although the medical community as a whole has not been particularly interested in investigating the specific functions of the foreskin, several unique features are now recognized. As discussed in Chapter 2, these include the fact that the foreskin is abundantly supplied with nerve endings which results in unique, sensual sensations; that it provides protection for the glans as an internal organ; and that it stimulates the glans and acts as a natural gliding mechanism during intercourse.

---

Dr. Sherman Silber reflects a similar attitude,

...if the child is not kept clean and if as he grows up he tends not to bathe enough, secretions can become entrapped and cause the foreskin to scar so that he indeed does have a problem. But if he was circumcised in infancy, he will never have to worry about any of this (8).

Dr. Lawrence Freedman prides the medical profession for their service to young men as follows:

Many wise physicians having performed routine newborn circumcisions have saved innumerable young men countless hours of having to perform the constant task of retracting their foreskins and extracting their smegma. Perhaps some of these young men have used this time in more profitable and pleasurable pursuits! (9).

---

hygiene should begin: Dr. E.N. Preston suggests three years (11); Dr. D. Gairdner suggests up to five years (12); and Dr. J. Øster suggests an even later age (13). One fact they all agree on, however, is that the infant penis needs no special attention to hygiene beyond the sort given to the infant female genitalia. In fact, serious harm can be done if retraction is forced before the glans and the foreskin have separated naturally.

As far as lifelong hygiene is concerned, there is never an age at which we can expect to no longer need to clean our teeth, shampoo our hair, wash our feet and ears, etc. Furthermore, care of the intact penis is considerably less complicated and time consuming than the care of some of these other parts of the body. Teeth need a good deal of time and effort to be properly brushed, flossed, and professionally cleaned. Hair must be shampooed, combed, and cut regularly to avoid odor, tangles, and parasites. Yet no parent I know would have their child's hair removed by electrolysis in order to spare the child the need for lifelong hygiene. Even to suggest such an extreme measure is ludicrous. Unless, of course, we are talking about the foreskin in America. In this country, there are doctors who will proudly explain their use of the newest laser technology in up-to-date circumcision techniques. And all of this to avoid teaching the intact male to regularly retract his

foreskin and rinse his penis in clear water or wash it with mild soap while washing the rest of his body.

As to the idea of 'time better spent,' I have made some calculations. If a 30-year-old intact male began to bathe himself at age five, and, if he spent 20 seconds a day retracting and rinsing under his foreskin, he will have invested approximately 50 hours of his life in penile hygiene. If, as Dr Freedman hopes, these hours have been more profitably and pleurably utilized by circumcised men, as a group, circumcised men should be wealthier and have known more pleasure than their intact counterparts—at least 50 hours worth. This whole exercise has made me, as a circumcised male nearer 60 years of age than 30, wonder just what I've accomplished with my 'gift' of nearly 100 hours of spared time. Upon reflection, I'd like to think that I've invested those hours in the writing of this book!

---

**Myth:** *Sooner or later the foreskin is likely to cause a serious medical problem; therefore, the individual is better off without it.*

Dr. Aaron J. Fink, who was a pro-circumcision activist and frequent talk show guest, often stated, "It is estimated that as a result of varied preputial [foreskin] problems up to 10% of males not circumcised at birth will eventually require circumcision" (14).

---

**Fact:** *Having a circumcision performed later in life in America and needing to be circumcised later in life are very different matters.*

When Edward Wallerstein questioned the health boards in Norway, Denmark, and Finland—all countries that do not practice infant circumcision—he found a very different situation than is found in this country. He reports:

In Oslo, Norway, over a 26-year period in which 20,000 male babies were cared for, 3 circumcisions were performed—a frequency rate of 0.02 %. In Denmark, 1,968 children up to the age of 17 were examined over a period of several years. In this group, 3 circumcisions were performed—a frequency rate of 0.15%. In this study, in retrospect, the physician believed all three operations might have been avoided. Both of the above studies related to the infrequency of circumcision in infancy and puberty; they did not deal with the issue in adulthood.

Health officials of each Scandinavian country were queried about adult circumcision....None of the health officials could provide precise data, because the numbers were

so small that they were not worth compiling. Each official stressed that foreskin problems were presented but said they were largely treated medically—surgical solutions were extremely rare (15).

More recently (1992), Dr. David H. Spach, et al., published an article entitled, "Lack of Circumcision Increases the Risk of Urinary Tract Infection in Young Men" (16). And in 1993, Dr. Thomas Wiswell, et al., published an article entitled, "Circumcision in Children Beyond the Neonatal Period" (17). Both articles conclude that the lack of circumcision contributes to medical problems later in life. Interestingly, Dr. Spach notes: "Because UTIs [urinary tract infection] occur uncommonly in young adult men, our sample size was relatively small [26 males, 8 of whom were uncircumcised] although we used a 3-year observation period." Dr. Wiswell's study reviewed the cases of 476 boys circumcised after their first birthday—70% for *nonmedical* reasons. Of the 30% circumcised for medical indications, 23% were for recurrent inflammation of the foreskin and/or glans and 7% were for UTI.

These articles highlight two common ways in which research data are misrepresented relative to male circumcision: 1) Findings concerning a relatively uncommon condition in the male population as a whole (UTI, penile cancer, phimosis, etc.) are used to suggest that circumcision is appropriate for *all* males. And 2) the current rise in the rate of later-age circumcisions, with their greater cost and risk factors, is used to encourage infant circumcision even though most later circumcisions are performed for nonmedical reasons. In this light, Dr. Wiswell's admonition, "Since circumcision in later childhood is more costly and may be associated with substantial risks, perhaps physicians should be more proactive in recommending neonatal circumcision," seems especially calculated and misleading. Further, it should be noted that the medical conditions indicated for 30% of the cases in Dr. Wiswell's study are, with rare exception, *treated and cured* by less drastic means in noncircumcising nations.

Finally, what are the real medical pros and cons of routine circumcision? Is the intact male apt to pay a price, either economically or in suffering, for having—and choosing to keep—his foreskin? A number of recent papers have analyzed the available data in an attempt to arrive at a factual basis from which to view routine infant male circumcision on *strictly medical grounds*. Due to the recent research emphasis on UTI, each of the following papers deals with that issue, with three of them including a range of other conditions. A complete discussion of each paper is beyond the scope of this book; however, even a simple listing of their titles, analysis method, and basic conclusions is very revealing:

- 1990 Robert S. Thompson, M.D., "Is Routine Circumcision Indicated in the Newborn?: An Opposing View" (18).

This study utilized an analysis methodology designed to differentiate and evaluate the risk factors of intervention as opposed to treatment of a disease already present.

Conclusion: The complication rate for circumcision (even at the lowest estimate) overbalances the "...price of a potential benefit to 9 [individuals] in 1000...."

- 1991 Theodore G. Ganiats, M.D., et al., "Routine Neonatal Circumcision: A Cost-Utility Analysis" (19).

This study "...analyzed the various costs and benefits of routine neonatal circumcision to 1) discover which elements in the circumcision controversy are significant and 2) estimate the cost-utility of the procedure using current data."

Conclusion: "For routine neonatal circumcision ...advantages and disadvantages cancel each other. Cost and health factors should be removed from the decision, and personal factors (e.g., cultural or religious) should be considered of primary importance...."

- 1991 Frank H. Lawler, M.D., et al., "Circumcision: A Decision Analysis of Its Medical Value" (20).

This study utilized "...a cost effectiveness analysis of the consequences of the treatment choices (circumcision *vs.* no circumcision) using a decision tree model."

Conclusion: "We conclude that there is no medical indication for or against circumcision....The decision regarding circumcision may most reasonably be made on nonmedical factors such as parent preference or religious convictions."

- 1992 John B. Chessare, M.D., MPH, "Circumcision: Is the Risk of Urinary Tract Infection the Pivotal Issue?" (21).

This study focused on the UTI issue and utilized a decision analysis model.

Conclusion: "For the set of values assigned to the outcomes, the choice of no circumcision yielded the highest expected utility....The choice of circumcision, excluding those for religious beliefs or cultural reasons, must be made by well-informed parents and should not be dictated by the risks of urinary tract infection alone."

- 1992 Dante Amato and Juan Garduno-Espinosa, "Circumcision in the Neonate Male and the Risk of Urinary Tract Infection During the First Year of Life: A Cross Analysis" (22).

This study focused on the UTI issue and utilized a cross-analysis method "...which combines the results of different studies, with the purpose of trying to obtain better conclusions about diagnosis, therapeutic efficacy or risk factors."



Conclusion: "Recommendation of routine circumcision to all newborns is not justified with these data."

These researchers all agree on one point: routine circumcision of the male infant cannot be justified on *medical*

grounds. It creates at least as many problems as it is purported to solve. After all that pain, suffering, and risk for tens of thousands of infants a year, the projected lifelong *net medical benefit* for circumcised males as a whole is zero!

**Myth:** *The infant foreskin should function normally at birth; unfortunately, many males are born with phimosis due to adhesions between the glans and the foreskin.*

The statements which have supported this myth through the years are far too many to give more than a few representative quotes:

Circumcision is medically obligatory if the foreskin is so tight that it cannot easily be retracted over the glans (23). ...it is important to consider phimotic pre-disposition....To determine predisposition [to phimosis] one grasps the prepuce...and pushes it....Mild bleeding will occur (24).

If your son has not been circumcised, cleaning his genitals involves pulling the foreskin back from the head of the

penis....Most babies at the time of birth have small, tight openings with adherent foreskin. This makes the pulling back process difficult at first....You may have to have Father help you at first with this pulling back. Many mothers have a difficult time making themselves do something that bothers their baby. If you shrink from doing this regularly, the foreskin will remain unstretched, and cleaning will be difficult....Irritation or infection can result (25).

Recently, Dr. Edgar Schoen of the American Academy of Pediatrics Task Force Committee on Circumcision, in a personal conversation with Marilyn Milos, R.N., contended that phimosis can be diagnosed in the infant as early as two months; and, on the same occasion, indicated that the presence of adhesions between the glans and the foreskin was evidence of the need for infant circumcision.

**Fact:** *At birth, 96% of infant males will have a non-retractable foreskin which gradually becomes retractable over the next several months or years. This developmental condition is not true phimosis. Further, the cells which bond the foreskin to the glans form a continuous membrane (synechia). This membrane is not morbid adhesions but a normal membrane found in the newborn.*

Most of us know that kittens and puppies are born with their eyes shut, and most of us know not to pry them open before nature opens them, all in good time. It would seem reasonable to suppose that doctors who have studied the structure and function of the human body would be familiar with the path of development which each of the body organs follows from its fetal stage to adulthood. And yet, as late as 1982 in a study conducted in San Diego, California, it was found that only 36% of the responding physicians were aware that the newborn's foreskin is characteristically not retractable (26). At the Second International Symposium on Circumcision (1991), Elizabeth Noble, P.T., reported on a recent study in which only 22% of the pediatricians surveyed had any knowledge that the foreskin was

nonretractable at birth or at what age retractability might typically be expected (27).

When I read a doctor advise both mother *and* father to tug on their infant son's foreskin to force it off and behind the glans for cleaning, I am astounded that such advice is followed. I am pretty sure that parents would not follow instructions to gently, but firmly, insert a small douche nozzle into the vagina of their newborn daughter in order to be sure that proper cleansing is accomplished. Somehow, we would know that such advice would be wrong. We seem to know that the vagina will take care of itself. So will the male's foreskin! Why don't we know that?

It seems particularly misleading for the medical profession to refer to the natural bonds between the foreskin and the glans of the newborn as 'adhesions.' While the typical layman may not know many medical terms, most of us know that adhesions are unwanted and unhealthy attachments which often form during the healing process after surgery or an injury. Therefore, when we hear the term, adhesions, most of us immediately assume that the condition needs fixing by some treatment. Not so in the case of the infant penis. The membrane (synechia) between the

foreskin and the glans consists of specialized cells which will totally disappear in all but a few exceptional cases by age 17. Rarely is medical attention needed to deal with this connective tissue—and then only after the age of 17 or 18 when it can be known *for sure* that nature did not quite finish the job.

The research evidence for the normal nonretractability of the infant foreskin continues to grow. Growing also is the number of voices to tell parents and doctors alike to leave the newborn foreskin alone: Gairdner (1949), Øster (1968), Reichelderfer and Fraga (1968), the AAP (1982), Fleiss (1989), and others (28). For those parents who wish more detailed information on care of the intact penis and how to know when and how to begin regular penile hygiene, the 1982 pamphlet: *WHEN YOUR BABY BOY IS NOT CIRCUMCISED* by Edward Wallerstein (29) is particularly helpful.

As to the possibility of diagnosing phimosis in infancy, R.J. McKay notes, “the prepuce [foreskin] of the newborn infant is normally so tight and adherent that no information can be obtained as to the later need for circumcision” (30). Sir James Spence deals with so-called infant phimosis in an even more poetic fashion, “What looks like a pinhole at seven months will become a wide channel of communication at 17 [years]” (31).

Before leaving this subject, mention should be made here of *acquired* phimosis and paraphimosis in infancy. These are conditions brought about by improper care of the infant penis. How ironic, parents who choose to leave their son intact are often warned by members of the medical profession that by not circumcising him at birth they are simply postponing the inevitable. Then, they are instructed

to forcibly retract the foreskin for cleansing and to check that it functions properly. This procedure injures the penis by tearing the natural connective tissue between the foreskin and the glans. Then, when the foreskin is replaced over the glans, the raw, torn surfaces grow together. And, what do you know, the child has *acquired* phimosis with true adhesions! Having predicted doom, the doctor has given the instructions most likely to assure that very outcome.

Furthermore, if a parent or doctor manages to force the infant foreskin back off the glans and then cannot get it back in place over the glans, the child may well develop *acquired* paraphimosis. That is, a case of paraphimosis which would not have occurred naturally if the foreskin had been left alone. Should such paraphimosis occur, the parent should know that circumcision is *not* the only remedy. Pressure and ice are often successfully used to reduce the swelling. Further, Dr. Ronald Illingworth has given instructions for doctors not only in the manipulation of the infant penis to correct paraphimosis but for injections to reduce the swelling (32). Such a mishap in infancy is not a clear indication that circumcision is warranted or that it will be needed later in life.

It simply cannot be said too often in this country, if the infant penis is intact, leave it alone until nature has completed the separation process. When an intact infant is taken for medical care, the parent must be sure that the doctor understands the nature of the intact penis. A parent or a guardian may well have to tell the doctor that they do not want the child’s foreskin retracted. In America, it cannot be assumed that the doctor will know how to care for the intact penis.

---

**Myth:** *Phimosis and paraphimosis are common developmental problems in the intact older child or adult and always require circumcision.*

Dr. Yosh Taguchi questions, “How can [infant] circumcision be considered unnecessary when...phimosis (inability to retract the foreskin over the head), and paraphimosis (the foreskin gets retracted beyond the head and cannot be returned) can only occur in uncircumcised

men?” In his discussion of phimosis Dr. Taguchi goes on to say,

The simple and only acceptable remedy is to carry out a circumcision. (It is possible to insert a forceps into the narrow foreskin opening and to stretch the channel open or to slit the foreskin vertically on top, but these are inferior methods of treatment since they run the risks of recurrent problems.) (33).

**Fact: *Phimosis and paraphimosis are rare conditions in countries where males are routinely left intact.***

The Finnish National Board of Health provided national case records for the year 1970 for both phimosis and paraphimosis. They report a total of 409 cases for men 15 years and older. This represents 2/100 of 1% (0.023%) of the total males in that age group. This means that 99.977% of the males in that age group did not present such foreskin problems. The Finnish authorities noted that only a fraction of the reported cases required surgery—a number too small even to estimate a reliable statistic. Furthermore, the authorities went on to note that surgical remedies were even rarer in the age group below 15 years (34). Further, Dr. Jakob Øster, a school physician in Denmark, reported that he found phimosis in only 1% of schoolboys over 14 years of age (35).

Note that Dr. Taguchi's statement above refers to *other* treatments and then dismisses them as unsatisfactory. Surely that choice belongs to the patient! Each and every option should be discussed with the individual for his consideration. Note that Dr. Taguchi says that the doctor could insert a forceps into the narrow opening of the foreskin to stretch the channel. He does not mention that the male, himself, can be instructed in a stretching routine to enlarge the opening of his own foreskin. In May, 1991, a reader who had already begun to stretch his tight foreskin opening wrote to Dr. James Gilbaugh to say that he did not want to be circumcised and to ask the doctor's opinion on his stretching 'exercise.' Dr. Gilbaugh replied:

There's no reason to resort to a circumcision yet, if you don't want to. A minor constriction band problem (called phimosis in your case or paraphimosis if the skin becomes trapped behind the head of the penis) can often be relieved by stretching the foreskin.

I recommend that you do this with a flaccid penis while bathing and with lubrication. The foreskin is very pliable and, in most cases, responds well to gentle stretching with the fingers. Over time, this may improve your condition considerably.

Various devices are available for stretching and lengthening the foreskin, but they're not necessary or advisable in your case. Just keep up the stretching and be patient (36).

In fact, a variety of nonsurgical procedures to treat phimosis have been documented; they include self-stretching of the restricted orifice, stretching under anaesthesia, balloon

dilation, and local steroid application (37). These procedures are either carried out by the individual himself or by the doctor on an outpatient basis. Unfortunately, such advice, instructions, or treatment procedures from a medical professional are not common in this country.

While either a ventral or a dorsal slit may not result in a very attractive foreskin, the procedure certainly ought to be explained and offered as a viable treatment procedure if the male wishes to retain his foreskin. Furthermore, such slits to correct phimosis are not the only surgical alternatives to circumcision. In the last two decades several articles have been published in the medical literature outlining a variety of surgical techniques for expanding the phimosed opening without circumcision (38).

Finally, if an adult elects circumcision, a partial circumcision is clearly an option. Since in an adult the raw surfaces are typically limited to the incision itself, there is no reason to surgically remove any more of the foreskin than that which is required to allow satisfactory retraction. The male circumcised as an adult need not be left with a bare, exposed glans unless that is his choice.

As to paraphimosis, it should be noted that the fear of the possibility of paraphimosis is often used to scare parents into circumcising their infant son. After all, what parents want to subject their son to the possibility of an embarrassing emergency because his foreskin got stuck behind his glans? The likelihood of this occurring is actually very remote. Gairdner reports that records at the Royal Victoria Infirmary show that 10 out of a total of 5,000 male surgical admissions (0.1%) were for paraphimosis (39). Which means, of course, that 5,000 infants would have needed to be circumcised to prevent the 10 cases—4,990 of which would never have needed the 'treatment.'

Again, common sense is needed. In other countries, the male with a tight foreskin which is likely to get stuck behind the glans and cause constriction is instructed how to clamp down on the glans with his thumbs and index fingers to reduce its size and to ease the foreskin back in place over the glans. The male with such a foreskin will no doubt also be advised to do something more permanent to correct the condition. The suggested treatments will include, however, most if not all of the less drastic measures mentioned above in our discussion of phimosis. 'Mechanical' difficulties with the foreskin rarely, if ever, require complete, radical circumcision in the American style.

**Myth:** *Circumcision is the appropriate preventative or treatment for urinary tract infection (UTI) and other troublesome irritations and inflammations.*

Beginning in 1985, Dr. Thomas Wiswell, et al., published a series of studies which reported a statistical correlation between infant circumcision and a reduced rate

**Fact:** *Any body part may, in fact, become infected. Treatment by amputation should be a last resort. What is more, Dr. Wiswell's research findings and conclusions have not gone without challenge on a worldwide scale.*

The rash of research and rebuttals set off by the Wiswell studies continues and is far too extensive to report here, but at least a few of the more salient issues should be dealt with. First, it should be noted that, in Dr. Wiswell's follow-up study of 422,328 infants, nearly half were female and that the female infants had nearly twice the rate of UTI (0.57%) as the male infants (0.31%) (both circumcised and uncircumcised) (42). Again, if you have an intact body part, it can become infected.

A second factor must be noted. There have been other studies which seriously challenge Dr. Wiswell's findings. Dr. Martin Altschul presented the results of his UTI study at the First International Symposium on Circumcision (1989). He reported that he,

...found not a single confirmed case of UTI in a normal male infant. All of the confirmed cases occurred in infants who had clear-cut urinary birth defects (43).

Dr. Altschul also examined the records of all infants under one year of age with UTI admitted to Northwest Region Kaiser Foundation Hospitals from 1979 to 1985. He found 19 cases out of a total of 25,000 infants (boys and girls). Of the 19 UTI cases, 14 were female and five were male. Three of the males were uncircumcised (0.12% or 3/2,500). Dr. Altschul concludes that such a rate "is not high enough to justify routine circumcision." Further, he speculates that the differences between his findings and Dr. Wiswell's may be due to "differences in foreskin care." (44).

Furthermore, Dr. Leonard Marino states,

It has been my custom for the last 15 years to do a routine urinalysis at 2 months of age. Rarely is any abnormality

of UTI. An overall summary of his findings indicate that from 1 to 4% of uncircumcised boys will have UTI before their first birthday and that most will spend about four days in the hospital (40). In an interview, Dr. Wiswell stated that, as a result of these findings, he has changed his original anti-circumcision position: "The numbers are so overwhelming that I had to reverse myself" (41).

found. In 15 years I have admitted only 3 infants to a hospital with illness of the urinary tract: two girls with hydronephrosis and a circumcised male with UTI.

...My experience reinforces the practice of discouraging routine circumcision, a cause of more morbidity than benefit (45).

Why such a vast difference in findings and conclusions? One possible explanation is that the parents in the Wiswell study were instructed "to gently retract the foreskin to allow the easily exposed portion of the glans to be cleaned." As has been discussed above, virtually all authorities, including the AAP, recommend that the newborn's penis be left alone—certainly within the first year. Dr. Stan J. Watson responded to this feature of the Wiswell studies by writing, "After 40 years pediatric practice, I am firmly convinced that the best hygiene is to keep hands off and to leave the prepuce [foreskin] alone" (46).

A second opinion as to why other researchers have not found the same results as the Wiswell studies comes from a group of doctors drawn from five different Swedish hospitals. They suggest that any increase in the incidence of UTI among intact males is due to the hospital birthing environment, not the foreskin (47). It has been noted that,

Kaiser hospitals (from which Altschul got his figures) commonly offer rooming in. Military hospitals (source of Wiswell's studies) frequently do not (48).

A third possible explanation focuses on the researcher's *interpretation* of the data, rather than on the numbers themselves. The fact that Dr. Wiswell sees the numbers as "so overwhelming" when, in fact, UTI is relatively uncommon in males (intact or circumcised) may reflect his own bias rather than the true medical picture. In a published interview, Dr. Wiswell is quoted: "If I can circumcise 1,000 or even 10,000 boys to prevent one boy from getting a kidney transplant, I believe it's worth it" (49). Further, Dr. Wiswell noted in a personal conversation in May, 1993, that he now believes the foreskin to be "a mistake of

nature” (50). These statements clearly do not reflect a high degree of objectivity relative to either the foreskin or routine circumcision.

Several doctors have attempted to give a ‘real-numbers’ perspective on circumcision as a preventative measure for UTI using Dr. Wiswell’s published data. Dr. George Denniston notes:

The largest number of infections that could be prevented by foreskin amputation, according to the author Dr. Thomas Wiswell, is 20,000 per year in the United States. So we should do 1,500,000 [estimated annual male birth rate] foreskin amputations to prevent infections, now treatable with antibiotics, in less than 2% of the infants? (51).

Dr. Robert S. Thompson notes that, “From the perspective of absolute differences, there will be 9 more urinary tract infections per 1000 newborns not circumcised” (52). And Dr. J.F. Knight calculates:

It would...be necessary to perform 419 routine circumcisions to prevent each UTI. Five thousand two hundred sixty-three [5,263] to prevent each serious sequela [complication](53).

Finally, concerning Dr. Wiswell’s caution of possible long-term kidney damage, Dr. Howard M. Snyder, III, in his study of UTI, observes: “...in my clinical experience of 20 years as a pediatric urologist, I have not seen any anatomically normal infant boys with urinary tract infection who ended up with badly damaged kidneys” (54).

---

**Myth: *Uncircumcised males are at higher risk for venereal disease than are circumcised males.***

The number of relevant quotes supporting this myth is too great to cite anything but a representative selection.

Dr. Vincent Vermooten bluntly states, “Circumcised men are less prone to venereal infection” (55). Dr. Marvin Eiger stated in 1972, “Certain types of venereal disease are rarer among the circumcised possibly because their penises are less subject to slight breaks in the skin that might admit disease germs” (56).

In 1973, Dr. Abraham Ravich published a book entitled, PREVENTING V.D. AND CANCER BY CIRCUMCISION (57). And in 1974, Dr. David Reuben published his very popular book, HOW TO GET MORE OUT OF SEX. In it he writes, “...military doctors discovered that circumcised men were less susceptible to Venereal Disease...(No one knows exactly why—maybe the foreskin simply gives germs a place to hide.)” (58).

While the above quotes are from older literature, it is important to note that the rhetoric goes on. More recently Dr. Aaron Fink wrote, “...estimates of relative risk suggest that uncircumcised men are twice as likely as circumcised men to develop genital herpes or gonorrhea and five times as likely to develop yeast infection or syphilis” (59).

Finally, it must be noted that two recent studies done in Africa reported a correlation between the presence of AIDS virus and uncircumcision. The media’s reporting of these studies clearly suggested that circumcision is an effective preventive measure relative to protection from infection by the AIDS virus. The studies collected data from heterosexual males who were being treated for sexually transmitted diseases at a Nairobi clinic. The research focused on those men who had frequented prostitutes in the nearby city. A correlation was found between the presence of a foreskin and infection with the AIDS virus (60).

---

**Fact: *No study has ever substantiated the claim that circumcision prevents or significantly reduces the risk of venereal diseases—even after more than 135 years of research.***

Even in studies where a higher percentage of the cases of the particular disease being studied are found to be in uncircumcised males, other contaminating factors always

help to explain the findings. Two famous studies, one in 1854-55 in London and the other in 1882-83 in New York, each found that, of all religious groups, Jews had the lowest incidence of venereal disease. The conclusion reached was predictable: circumcision helped prevent venereal disease. In those less scientifically sophisticated days, such factors as Orthodox religious practices, Jewish family life, and the social isolation of Jews were not factored in (61).

We can get a better perspective on the supposed link between uncircumcision and venereal disease if we consider the rise in the rate of Herpes II (caused by a virus) and of gonorrhea (caused by bacteria). During the years from 1945 to 1976, the reported number of cases of gonorrhea in the United States skyrocketed from 313,000 to 1,002,000. And in 1975 alone the new cases of Herpes II were estimated at between 250,000 and 1,000,000. The major fact to consider in relation to these figures is that the vast majority of sexually active men during the years cited were circumcised American males. As Wallerstein points out,

If circumcision were the remedy, because of the high circumcision rate in the United States, all venereal diseases, including Herpes II should have largely disappeared. They have not (62).

In 1994, Linda S. Cook, M.S., et al., reported a study which explored the relationship between circumcision status and sexually transmitted diseases. The subjects were 2,776 heterosexual men who attended a sexually transmitted disease clinic. Since the correlation of circumcision status was mixed relative to the incidents of the various diseases considered, the authors conclude: "The results of this study do not show a definite benefit of circumcision" (63).

The implied connection between infection with the AIDS virus and the presence of a foreskin is equally questionable. The studies cited above were done in Africa amid socioeconomic conditions very different from those in the United States. These studies have been called into question for not taking into consideration such issues as the socioeconomic status of circumcision within the various

social groups, the social status of the prostitutes, etc. Any one such factor could possibly explain the apparent relationship. The most important message for the American public, however, is that *circumcision does not prevent AIDS!*

It is, again, important to note that the United States Public Health Service reports that the AIDS rate is 60.0 per million in the United States where an estimated 65% of sexually active males are circumcised compared to 1.6 per million in Italy, 4.0 per million in Great Britain, and 8.5 per million in France where very few males are circumcised (64). Preventive changes in sexual practices, not circumcision, is the *only* protection from the AIDS virus!

In an effort to explain this country's high AIDS rate, Dr. John Swadey states an opposite point of view relative to circumcision. In a letter to the NEW ENGLAND JOURNAL OF MEDICINE, he writes, "common speculation tends to link American circumcision practice to AIDS." Dr. Swadey says that his examination of circumcised American males "discloses a very significant incidence of persistent suture holes, micro-sinuses, skin tabs and bridges, irregular scarring" around the circumcision scar which are subject to abrasion (65). Again, it is important to note that Dr. Swadey's statements are 'common speculation.' But, clearly, having a circumcised penis has not generally protected the American male population from the threat of AIDS. Dr. James Curran, Director of the Federal AIDS program in Atlanta, has noted that he has seen "no scientific data" linking circumcision to the transmission of AIDS. "Both intact and circumcised men have become infected" (66).

---

**Myth: *Having a foreskin puts the male and his sex partner at higher risk for cancer.***

The three cancers most frequently linked with uncircumcision are cancer of the cervix in women and cancer of the prostate and of the penis in men.

**Cervical Cancer.** In the early 60s, Dr. S.I. McMillen published his book entitled, NONE OF THESE DISEASES. In that book he reported several studies, current at the time, which concluded that cervical cancer was linked to uncircumcised sex partners. Taking the position that Old Testament ordinances are God-given protection against such diseases, Dr. McMillen noted that 13,000 women had

died of cervical cancer during a representative year and then went on to say, "the large majority of deaths could have been prevented by following an instruction that God gave to Abraham" (67).

Dr. Sherman Silber, in 1981, took a 'better safe than sorry' attitude:

A...benefit of circumcision is that wives of circumcised men are less commonly afflicted with cancer of the cervix (the opening of the woman's womb). There is controversy currently among doctors on whether it is circumcision that protects against cancer of the cervix, or whether it is some other aspect of hygiene in circumcised men that is responsible. Regardless of the reason, these women are much less

likely to suffer the most frequent cancer of the female organs (68).

**Prostatic Cancer.** In 1972, in TODAY'S HEALTH, Dr. Marvin Eiger stated, "The uncircumcised man is more than twice as likely to develop this [prostatic] form of cancer" (69).

**Penile Cancer.** Although cancer of the penis is among the rarest cancers to strike males, it is used often to argue for infant circumcision. Dr. Taguchi states,

How can circumcision [at birth] be considered unnecessary when cancer of the penis...can only occur in uncircumcised males....Urologists, I suspect, favor circumcision on newborns. Seeing a case or two of cancer of the penis can affect one's outlook significantly (70).

**Smegma Causes Cancer.** The idea that smegma *causes* cancer has been reported in medical literature for a very long time. Dr. H. Speert stated in 1953, "Smegma has long been assumed to be the tangible agent responsible for carcinogenesis in the penis" (71).

**Fact:** *When studies are done comparing matching groups of men in circumcising and noncircumcising nations, the United States does not have the lower rates of these cancers which would be expected if infant circumcision were the significant factor in preventing them.*

**Cervical Cancer.** It took several years to get a better understanding of this issue. During the 1930s and 40s, the fact that Jewish women had a low incidence of cervical cancer was widely publicized. But it was not until the mid-50s that the apparent link between circumcision and cancer of the cervix was given the status of a 'discovery.' TIME magazine, in 1954, ran an article entitled, "Circumcision and Cancer," which reported on a study done by Dr. E. L. Wynder, et al. Unfortunately, the popular press did not report on the entire study which went on to say, "...cancer of the cervix has been noted in women exposed only to circumcised males and in virgins" (72).

It is interesting to note in Dr. Silber's statement above that he questions whether it is circumcision *in men* or some other aspect of hygiene *in men* which governs the female's susceptibility to cancer. Nowhere during this period was the cause associated with the woman's behavior relative to cervical cancer. The debate lasted for several years, but finally even the most dedicated proponents of infant circumcision had to acknowledge that factors other than the circumcision status of the male sex partner accounted for cervical cancer.

By 1984, Dr. S.I. McMillen noted in the second edition of NONE OF THESE DISEASES,

In the first edition of this book, I cited the evidence that cancer of the uterine cervix...was primarily a disease of

sexual partners of uncircumcised males. In the intervening years, however, cervical cancer has been more firmly related to multiple sex partners....A recent study found evidence of venereal warts virus in 73 of 80 women who had cervical cancer. Thus, it seems that cervical cancer is, for the most part, a result of venereal disease...(73).

In spite of many such attempts to set the record straight, the myth lives on. The old barracks song declares: "Old soldiers never die; they just fade away." Unfortunately, old circumcision myths do neither! Whether it's a 1992 article about Jewish refugees from Russia seeking circumcision who "...were persuaded to act by their wives, who feared a risk of cervical cancer" (74) or *Ann Landers* printing a letter in 1993 from "Old Doc in Kentucky" (75), the misinformation never seems to stop. In the meantime, one cannot help but wonder how many infant boys have been needlessly strapped to a circumcision board to have their foreskin amputated in an effort to save their future wife from cancer.

**Prostatic Cancer.** Dr. Eiger's conclusion that "the uncircumcised man is more than twice as likely to develop this form of cancer" was based on a study by Dr. A. Apt which compared the incidence of prostatic cancer in Sweden [noncircumcising] and in Israel [circumcising] (76). Unfortunately, Dr. Apt did not take age into consideration. It is well established that prostatic cancer is most often found in men over the age of 55-60. Dr. E.N. Preston reanalyzed Dr. Apt's data taking into account the proportion of the population in both Sweden and Israel aged 60 and over. He found that Sweden had 7.2 times as many men in the older age group as did Israel. Based on this fact, Sweden would be expected to have 7.2 times as many incidents of prostatic cancer as Israel. The data, however,

showed a difference of only 4.7 times that of Israel's. Dr. Preston asked, "Would this mean that noncircumcision protects against prostatic cancer?" (77).

In summarizing his discussion on prostatic cancer, Wallerstein states,

...we see that the overwhelming epidemiological data demonstrate that the cause of prostatic cancer remains a mystery. Its etiology has nothing to do with circumcision, yet the myth persists in current medical literature (78).

**Penile Cancer.** First, the statement that penile cancer can only occur in uncircumcised males is simply untrue. Wallerstein notes,

It is true that penile cancer is exceedingly rare among Jews; however, since 1932 at least 6 articles reporting individual cases of penile cancer among Jews circumcised in infancy have been published in American medical literature. In these 6 cases, reasonably good body and good genital hygiene was practiced (79).

More recently (1993), Christopher Maden, Ph.D., et al., reported a study in which 110 men with penile cancer, diagnosed from January, 1979, to July, 1990, were interviewed. Of these 110 men, 22 had been circumcised at birth, 19 later in life, and 69 never. While the majority were either intact or circumcised later in life, 20% of the men interviewed had been circumcised as infants. The authors suggest that other factors—among them cigarette smoking, genital warts, and 30 or more sexual partners—may contribute to the risk of penile cancer (80).

Second, if infant circumcision reduces penile cancer we could expect to see proportionately less penile cancer in circumcising nations as compared to noncircumcising ones. No such difference is found. Wallerstein reports that, for various years between 1966 and 1972, the annual rate of new cases of penile cancer was 0.8 for the United States which circumcises and 0.5 for Finland, 0.9 for Denmark and 1.1 for both Norway and Sweden. None of these

differences is significant. Further, within the same time frame, both France and the United States had the same, 0.3, rate of deaths due to penile cancer (81).

Dr. George Denniston notes,

Cancer of the penis is very rare—one case in 100,000—usually in older men. Even if circumcision could prevent it, 100,000 foreskin amputations would be necessary to prevent one cancer of the penis. One hundred thousand infants would be mutilated, and several infants would die to prevent that one case of cancer. Who could scientifically advocate foreskin amputation for this reason? (82).

Finally, Dr. Taguchi remarks that he suspects that urologists favor infant circumcision because, "Seeing a case or two of cancer of the penis can affect one's outlook significantly" (83). Unfortunately, due to the high degree of specialization in modern medicine, those same urologists are not apt to see the even greater number of mutilated or brain-damaged infants whose fever was brought on by infection in the circumcision site—nor to sign the death certificates of those infants who did not survive. If urologists saw the whole picture, I have every reason to believe that their efforts would turn to promoting education regarding the need for proper penile hygiene for intact males rather than to promoting infant circumcision.

**Smegma as the Carcinogenic Agent.** Wallerstein notes,

All mammals produce smegma, and none is circumcised. When mammals reproduce, smegma is deposited. If smegma contained a carcinogen or even an irritant, then the propagation of the species would be jeopardized. No such phenomenon exists (84).

In a definitive statement, E. Grossman and N.A. Posner assert,

No one today seriously promotes circumcision as a prophylactic against cancer of any form. No significant correlation between cancer and circumcision has ever been proved (85).

---

**Myth:** *Newborn infants do not feel pain. Or, more recently, they do feel pain; but it is minor, of short duration, and is not remembered. Therefore, the first few hours or days of life are the optimum time for male circumcision to be performed.*

The erroneous idea that the newborn does not feel pain is very old indeed. THE MOTHERS' MEDICAL ENCYCLOPEDIA (1972) simply stated, "Circumcision of a newborn boy is not painful for the child" (86).

Dr. Marvin Eiger has stated that when the surgery is done in the first two or three days after birth "...discomfort



is minimal, since the fairly subdued infant is relatively insensitive to pain” (87).

Dr. E.T. Wilkes said that circumcision was “not very painful” (88). Dr. F.W. Rutherford stated that “circumcision is momentarily painful” (89). And Dr. Charles Schlosberg declared that “the infant feels as much pain momentarily as he would while receiving an injection” (90).

And, as late as 1988, Dr. Edward B. Blackmon, Jr., maintained:

While the foreskin is clamped, the body produces a ‘natural local anesthesia’ through the process of accommodation. After a short period of time the nerves in the clamped foreskin no longer send ‘pain messages’ to the brain. When the skin that was clamped is cut there is no perception of the cutting (91).

---

***Fact: Infants not only can, they do feel pain, and there is now a great deal of research evidence to substantiate this fact.***

It is true that, if the mother has been sedated just prior to and during delivery, the infant will have the same medications in his body as were administered to the mother. Dr. T.B. Brazelton estimates that it takes at least a week for the newborn to excrete such medications from its body (94). The fact that infants who have been sedated along with their mother are lethargic immediately after their birth in no way implies an underdeveloped nervous system. Further, the practical consequence of the current trend toward more natural birthing procedures is that newborn males will be more wide awake than ever for their ordeal on the circumcision board.

The body of research related to the whole question of the infant’s experience before, during, and following birth is growing yearly. The First International Conference on Infants Studies (1978) reported:

Physicians and medical researchers are finding that babies can have all of these experiences [hearing, seeing, touching, and emotions] much earlier in life than was previously believed (95).

Dr. Howard J. Stang, et al., (1988) described the infant’s pain as follows:

There is no doubt that circumcisions are painful for the baby. Indeed, circumcision has become a model for the analysis of pain and stress responses in the newborn. Not

The idea that the cries of the child are due more to the restraints than to pain is also frequently stated. Dr. Yosh Taguchi says, “Every baby cries lustily throughout the ordeal, but I am not certain whether the infant is objecting to being strapped down or to the clamp” (92).

Dr. Seymour Isenberg and Dr. L.M. Elting go further in their statement:

As for anesthesia, none is needed. Although the baby may scream and kick during the procedure, this seems to be more a reaction to being bundled to the circumcision board than actual pain. Many babies fall asleep during the process. Since a good portion of the baby’s nervous system is not yet formed, especially that part that localizes pain, circumcision done at this age the first days after birth is probably the best time (93).

only does the unanesthetized newborn cry vigorously, tremble, and, in some cases, become mildly cyanotic because of prolonged crying, but other stress-related physiological reactions have also been demonstrated, including dramatic changes in heart and respiratory rates and in transcutaneous oxygen and plasma cortisol levels (96).

Dr. David Grimes further noted “the propensity...to vomit” (97). And Drs. C. Kirya and M.W. Werthmann, Jr., noted that the infant’s prolonged crying occasionally “results in respiratory pauses and regurgitation of feedings” (98). It has, in fact, been suggested that surgeons keep a suction unit on hand “to clear possible regurgitation” during the surgery (99). Pain seems the only possible explanation for these descriptions and warnings.

In a published interview, Dr. Howard Marchbanks stated,

In medical school I was taught that the baby’s nervous system is not developed sufficiently to be aware of the pain of circumcision. But my experience in doing it and observing the baby’s reactions tell me otherwise....Anyone who has a foregone conclusion that it was not painful for the baby and therefore one should not hesitate to do it only has to listen to the baby while it is being done (100).

When is the optimum time for male circumcision? When the consenting male elects the procedure! Dr. Marchbanks concludes his interview with this statement: “I have nothing against circumcision, but I think the individual should have a say in the decision” (101).

**Myth: *Routine infant circumcision is virtually risk free.***

Quotable statements which perpetuate this particular myth are more difficult to find in the literature than are statements reflecting some of the other myths. This situation is true because most doctors simply do not talk about circumcision risks—even when talking with parents and having a consent form signed. Further, few doctors would ever go on record to say that any surgical procedure is absolutely risk free.

Nonetheless, Dr. R.L. Wall, Jr., published an article on circumcision in the NORTH CAROLINA MEDICAL

JOURNAL (1968) in which he essentially denied the existence of any risk, quoting statements based on the recollections of a ‘distinguished physician’ regarding many thousands of circumcisions performed at Johns Hopkins Hospital (102).

In discussing the rarer, but more serious, problem of accidental mutilation during a circumcision, Dr. Yosh Taguchi, who favors infant circumcision notes,

Mutilation of the penis at circumcision is a freak accident, like an amputation of the wrong limb. It can happen, but cannot be advanced as solid argument [against infant circumcision] (103).

**Fact: *Hemorrhage, infection, and surgical injury all occur with some degree of regularity and, occasionally, even death as a result of infant circumcision.***

Before we consider the particular complications named above, let me report a portion of a presentation made to a subcommittee of the California Medical Association on March 4, 1989. The presentation was by Dr. James L. Snyder:

In 1986, I presented to the Virginia Urologic Society two infants who had been circumcised with disastrous results. One had suffered a degloving injury with the loss of all the skin of the penile shaft and required further surgery. The second infant suffered gangrene and necrosis of the entire glans and penis due to electrocautery. I was called as a consultant to see both of these infants within hours of the injuries and can tell you that both of these children will be lifetime genital cripples.

Since my two personal experiences witnessing tragic infant circumcision, I have gathered data which I bring here before you on other tragic results of infant circumcision.

In 1982, an Iowa infant bled to death after circumcision.

In 1983, another Virginia child suffered a degloving with his circumcision, requiring skin grafting.

In 1984, a Louisiana child’s penis was destroyed by a circumcision and sex-change surgery was advised.

In 1985, two children in an Atlanta hospital suffered destruction of their penis at circumcision. One underwent sex-change surgery.

In 1986, an Alaska child’s infected circumcision led to convulsions and massive brain and kidney damage.

Numerous children are cut so short that their sexual functioning is compromised and recently the medical literature and the lay press have reported on significant numbers of adult men who were so displeased with the fact of their circumcisions that they have sought and submitted to plastic surgical reconstruction of their penis (104).

**Hemorrhage.** Wallerstein notes,

The most common circumcision complication is hemorrhage. According to Dr. John Denton (1978) the ‘rate reported at times as being up to 2%.’...In some cases, hemorrhage was so severe that heroic measures had to be taken, including blood transfusion (105).

**Infection.** Studies reported in CARE OF THE WELL BABY (1968) compared groups of circumcised infants with intact infants. Five (2%) of the circumcised infants in one study group developed blood poisoning as a result of circumcision, and two ultimately required transfusions. The authors of this study, commenting about their experience with circumcision in general noted,

In our experience, we have found cases of staphylococcal pneumonia, ascending urinary infection, and sepsis that have resulted from infection at the site of circumcision (106).

Such infections can be relatively minor and, if so, are usually rather easily treated with antibiotics. Infections, however, can be more serious and can result in dangerously high fever. Such fevers have resulted in both brain damage and death.

**Surgical Mishaps.** Compared to the number of circumcisions performed in this country during this century, serious surgical mishaps are relatively uncommon; they do, however, occur. The term, ‘serious,’ is difficult to define in

this instance. Mishaps such as stitches being taken through the urethra, niches accidentally taken out of the glans, pits in the surface of the glans due to the ‘skinning’ procedure, the urethra cut through, etc., are probably considered relatively minor by the medical profession—as opposed to the individual who grows up with that particular penis.

There are cases, however, where the injury to the penis is so severe that plastic surgery is necessary to repair the damage. In 1976, Dr. S.B. Levitt and associates described the plastic surgery they employ to correct circumcision mishaps. They reported one case where, even after the corrective surgery, “the deformity of the glans and penis persists” (107).

Dr. Sherman Silber, who favors infant circumcision, relates the following incident:

Circumcision is basically a very safe procedure, but it is not without occasional disaster. When I was a first-year resident in urology I received a call from a rather nervous nurse in the neonatal nursery unit. There had been five children born several days earlier that she wanted me to take a look at, but she would not explain the problem over the phone. When I got to the nursery she explained to me that a new pediatric resident had just rotated onto their service and the day before had performed the usual circumcisions on newborn babies. He had mentioned nothing to anybody on the staff to indicate that any problems had occurred or that he was aware of any problems, but the nurse noted that morning that none of those five children had very much penis left.

Unfortunately, this is a procedure considered to be so simple and relatively unimportant in the medical world that frequently the least experienced doctors are sent to do it...I must add that the particular doctor involved was a nice fellow who simply didn’t realize the gravity of what he had done. Luckily, with plastic surgery, the penises of all of these children eventually healed without any deformities sufficiently severe to mar their later life (108).

Electrocautery devices have caused severe damage in several noted incidents since the 70s. In one case, reported by Dr. John Money and Patricia Tucker, the entire penis sloughed off. In this case, the child underwent sex-change surgery and has been raised as a girl (109). In August, 1985, as noted in Dr. Snyder’s report, two infants, circumcised the same day in the same hospital in Atlanta, received such severe burns from the use of an electrocautery device that one required a sex-change operation and is also being raised as a girl. The other boy, whose parents would not

permit a sex-change operation, will, according to a 1991 news report, “never be able to function sexually as a normal male.” In that report, a \$22.8 million settlement was announced (110).

**Healing Mishaps.** ‘Skin bridge’ is the term used to describe a condition in which the circumcision incision (scar) bonds in places with the raw, denuded infant glans during the healing process. This usually occurs unevenly so that it does not involve the entire scar around the penis. These ‘bridges’ form tunnels between the scar and the glans. I have seen pictures of one adult male in which five such ‘bridges’ could easily be observed.

Acquired phimosis following circumcision is another healing mishap. In this case, enough of the foreskin or shaft skin is left so that the remaining skin collapses back over the raw glans and attaches to it. *These bonds are true adhesions* and must be treated. The following is a mother’s account of the doctor freeing her 20-month-old son’s postcircumcision adhesions:

My sister accompanied us and the doctor instructed my sister and me to each pin down one of Colin’s arms and legs. He then—*using no anesthesia*—tore the foreskin from all around the glans. It was minutes of horror!! Perhaps it was worse than his original circumcision, for now he could recognize exactly what was happening. Here were three adults, two of them close love-figures, restraining him and putting him through this agony!! He screamed, ‘Mamma, Daddy, Lola...I’m sorry, I’m sorry...Mamma...’ over and over again. My poor baby, sorry for what!?!? I was the one to be sorry....After the doctor was done with Colin he had us put ointment on the wound until it healed. This took two adults just to pin him down again to get the ointment on. For weeks after this ordeal Colin wouldn’t allow anyone near his penis (111).

**Death.** In an article entitled, “Should Your Child Be Circumcised?,” FAMILY HEALTH claimed in 1972 that death due to circumcision could be attributed to “pneumonia, blood poisoning, liver or kidney failure” (112). Anne Briggs notes, “...one thing can be generalized about circumcision deaths: they are almost always traceable to infection in one way or another” (113).

Dr. Sidney Gellis, in 1978, stated boldly, “It is an incontestable fact at this point that there are more deaths each year from complications of circumcision than from cancer of the penis” (114). Again in 1981, Dr. Hank Streitfeld published the same conclusion: “...in the United

States today, fewer men die each year of penile cancer than of complications resulting from the circumcision procedure itself.” Dr. Streitfeld further noted: “In America, with millions of elective circumcisions performed annually, about five little boys will die each year as a result of infection or bleeding” (115). The Florida papers reported one such death in June, 1993. A six-month-old boy bled to death after a routine circumcision had been performed in the doctor’s office (116).

In reviewing the literature on the risks of circumcision,

**Myth: *Infant circumcision does no harm to the ‘penis itself.’***

This myth generally means that the circumcised penis still functions for its ‘intended’ purposes. Circumcision, itself, is not considered by the American medical profession as ‘harm’ to the penis. Dr. Sherman Silber states,

There is one clamp technique for circumcision, called the guillotine approach, which can appear very frightening. In this procedure the foreskin is pulled and stretched far beyond the tip of the penis and then clamped in guillotine fashion and literally chopped off. To the watching parents it would appear that the tip of the child’s penis is being cut off, but of course that isn’t what is happening. After the procedure is completed, the foreskin is retracted and the frightened parents can see that the child’s penis has been *unharmmed*.

**Fact: *The foreskin is a valid part of the ‘penis itself,’ and circumcision often results in very harmful effects.***

The purpose of the foreskin and the part it plays in the function of the natural penis have been discussed at length in Chapter 2. And the harmful effects of circumcision were presented in Chapter 3. One particular harm done to the penis by routine infant circumcision ought, however, to be emphasized here. Excessive removal of skin is a condition which just as well could have been discussed above as one of the risks of infant circumcision. It is, however, my experience in dealing with men who contact UNCIRC that tight, taught, and even painful erections are so frequent that they reflect the *style* of circumcision in America rather than a mishap. I know of men with scrotal and abdominal hair growing thickly on the shaft of their penis right out to their circumcision scar which is fre-

I’m struck by one very interesting and disquieting theme: The medical profession prods itself to find ever safer, more reliable techniques both in procedure and aftercare in order to reduce the risks of routine infant circumcision. Rarely, if ever, does the medical literature question the advisability of continuing a tradition which so regularly results in complications, mishaps, and deaths.

After the circumcision there is always a raw area between the glans (i.e., the tip) and the skin of the shaft of the penis. This can look rather frightening and give the parents the impression that something terrible has happened to their little boy’s penis. Sometimes this raw area bleeds, frightening them even more. *Neither the raw area nor the bleeding need really alarm them*, because after a week the raw tissue will gradually be covered with skin that migrates from the cut edges, and the area will heal uneventfully (117). (Emphasis JB)

It should also be noted that Masters and Johnson, no doubt unintentionally, helped perpetuate this myth when they reported that they found no difference between circumcised and uncircumcised males relative to penile sensitivity (118).

quently midway out the penile shaft. I know of one man living on the West Coast who had virtually all the shaft skin removed. His circumcision scar is at the base of his penis—at the hairline on the top of his penis and down onto the scrotum underneath it. While this case is extreme, over and over men complain on the questionnaires we circulate, “I was cut too tight,” “I have no slack skin on the shaft of my penis,” and “I was cut so tight my penis bends up (or down or to one side).”

Obviously the small penis of an infant, covered with blood from a dorsal slit and having had the glans skinned, is a difficult object on which to make surgical judgments. All the more reason not to be doing the procedure in infancy! How any doctor can say that infant circumcision does the penis no harm is quite beyond my comprehension.

Finally, it should be noted that the Masters and Johnson study, so often cited by pro-circumcision advo-

cates, compared the sensitivity of the circumcised and uncircumcised penis to direct pressure and touch. The sensations and responses which are muted by circumcision are of a far more subtle and sensual nature than anything their study researched or documented. When a male, circumcised as a sexually active adult, states, “On a scale of 1-10, intercourse with my foreskin was at least an 11 or 12—without it a 3,” he isn’t describing his ability to detect the presence or absence of pressure applied to his glans by the blunt tip of a research instrument! (119).

**Myth: *You can depend on statistics.***

Before leaving the circumcision myths which are typically based on some sort of medical research or conclusion, it would be wise to look at the whole issue of *correlation*. This is a statistical concept which simply measures how often two conditions or events are found together. In research such as I have been quoting in this chapter, we often find such statements as, ‘15% of the uncircumcised males were also found to have...,’ etc. Frequently, such findings are then used to suggest that the presence of a foreskin *caused* or *greatly contributed* to the particular condition under investigation.

When I was a young man just beginning my degree programs, I had a very demanding statistics professor. He was determined, if he could help it, that none of his students were going to ‘get out there and make fools of themselves.’ He would constantly remind us of the many pitfalls involved in drawing early conclusions from correlational data. “Such findings only tell you where to look further,” he would say. “That’s when the real work begins. Having found a correlation, you must do carefully controlled investigation to discover whether or not other factors are influencing both of the events which you found to be somehow related.” Then he would get a twinkle in his eye and shake his finger in the air and recite: “Just remember, when icebergs float down the Atlantic, flowers bloom in Central Park!”

These cautions tell us, for instance, that, when it is reported that more of the uncircumcised males who visited prostitutes were found to be infected by the AIDS virus than the circumcised males, we have to ask further questions to isolate the ‘real’ cause. Is it, indeed, some function of the foreskin itself, or do these uncircumcised men differ

Actually, I queried Dr. Wiswell in Santa Fe, New Mexico (May 8, 1993), when he used the Masters and Johnson (1960s) study to support his contention that circumcision does not diminish penile sensitivity. He replied that he realized Masters and Johnson had not studied sensual responsiveness per se but that, in the absence of a more pertinent study, he cites their work because everyone recognizes their well-known names. I’m sure the look on my face betrayed my disapproval of that sort of garnering accreditation by ‘dropping’ famous names.

from the circumcised males in some other *consistent* ways? The fact, for instance, that in Africa circumcision is frequently practiced by a higher classed, better educated, and wealthier sub-group calls into question whether the ‘real’ cause is the foreskin or matters of regular hygiene and living conditions—or even the lower price that the uncircumcised men would no doubt have paid for the services of a prostitute and in what part of the city they found her. Clearly, the findings in many of the studies reported in this chapter tell us to *look further*; they do *not* tell us that the presence of a foreskin is the *cause* of or *greatly contributes* to the problem. We really ought to have learned our lesson from the ‘fools we made of ourselves’ over the supposed link between uncircumcision in males and cervical cancer in females. We got fooled! And thousands of our baby boys got robbed as a result of that erroneous conclusion.

We need to develop a healthy skepticism about research data until we know the particulars of the study which produced them. We need to be particularly wary of how research findings are reported and used by the media and by those who have something to gain from the conclusions which they draw. My mother’s rather cryptic warning may have some merit here: “Remember, figures don’t lie, but liars figure.”

We need to be more insistent on hard evidence from better controlled studies before we jump to conclusions about any significant subject. We live in a day when ‘the results of studies’ influence nearly every aspect of our lives. In this case, the act of infant circumcision is simply too violent, painful, and permanent for our sons to allow ourselves to be influenced by anything short of clear proof that we are truly bettering their life.

In the next chapter we will look at several circumcision myths that are deeply rooted in some of our basic social and even political beliefs.

# 5

## Common Circumcision Myths Which Cloud Social Issues

*“It is not the facts which guide the conduct of men, but their opinions about facts; which may be entirely wrong. We can only make them right by discussion.”*

**Sir Norman Angell**

There are a number of circumcision myths which reflect social issues in our culture. For instance, it has not been common in our society to think of a child as having the human rights which we normally associate with adulthood. While we would not think of forcibly circumcising an adult male who did not choose the procedure, we assume that as adults we know what is best for a child in this matter. Some parents even believe that it is their *duty* to make the circumcision choice for their son. Actually, no malfunction of the foreskin, other than an obvious birth defect, can be diagnosed in infancy or childhood. Therefore, no choice

*needs* to be made at birth. Rather, it seems logical to wait and allow the young man to choose among his options and needs as an adult. Yet, such a simple idea alludes us. Having bought into the myth that a circumcision is much harder for an adult to go through than an infant, we can even assure ourselves that we’re doing the baby, and the man he’ll become, a favor. In this chapter, we will discuss several such myths which have grown up surrounding some of the less tangible aspects of infant circumcision.

---

**Myth:** *Adult males do not like to undergo a circumcision; therefore, it would be best to circumcise all infant males at birth—it is kinder to them.*

Dr. Sherman Silber reinforces this myth in his discussion of circumcision,

For the newborn infant the operation is really fairly simple. Although it must be very painful the child is traditionally not given an anesthetic because the risk of doing so would

be too great. Furthermore, most medical authorities feel that the brief pain caused by the operation has no harmful effect on the child....The operation is much more involved and painful for an adult than for a newborn boy. So if a male is going to be circumcised, he would be wise to have it done before he leaves the hospital nursery (1).

Dr. Yosh Taguchi says it in a different way, “Ask any man who has had to have a circumcision as an adult if he would not have preferred the procedure at birth” (2).

**Fact:** *There is evidence that circumcision is more painful for an infant than for an adult. Further, several factors during the recovery period add to the infant's discomfort and pain.*

The myth that circumcision is worse for an adult than an infant is frequently used to convince parents to 'have it done, and get it over with.' Actually, this myth is closely related to the old myth that infants do not feel pain; therefore, infancy is the optimal time for circumcision.

Not only is there no evidence that the circumcision procedure is less painful for an infant, the very fact that infant circumcision is typically performed without anesthetic ought to convince anyone that the child will have a far more painful and terrifying experience than an adult. There are several factors which must be noted here. First of all, the normal adult male who needs a circumcision will not need to have his foreskin painfully stripped from his glans. Further, he will be given information, explanation, and an anesthetic before the procedure. As an adult, he can discuss issues of style with the doctor who will not need to wonder how much skin this particular male will need when he grows up. And, after his surgery, the adult will be given pain medication for as long as he is uncomfortable.

All of these conditions are very different for the infant who will have a raw and bleeding glans as well as an incision, who will urinate and defecate all over his wounds, and who may scream every time his diaper is changed or he is held closely for weeks after the procedure.

Before leaving this myth, I must say that I find Dr. Taguchi's argument particularly troublesome. He says, "Ask any man who has had to have a circumcision as an

adult if he would not have preferred the procedure at birth." There are two major issues raised by this argument. First is the actual likelihood that a given adult male will need a circumcision. As noted earlier, Dr. Aaron Fink, who favored routine infant circumcision, estimated that up to 10% of all uncircumcised males will eventually require circumcision. There seems little doubt that this estimate is highly inflated and reflects the tendency in this country to over prescribe circumcision as a treatment procedure. Nonetheless, even by this inflated estimate, at least 90% of all uncircumcised males will never require circumcision. Therefore, in order to be sure that we 'catch' the 10% who could need circumcision sometime during their lifetime, we will need to circumcise hundreds of thousands of infants every year who would never require the procedure at any time, for any reason.

The second issue has to do with hidden implications in Dr. Taguchi's argument. As a psychologist, I can say with a high degree of certainty that most any human being anticipating an unpleasant experience wishes it were over and behind them. This would seem to be a natural human tendency. In the case of infant *vs.* adult circumcision, however, Dr. Taguchi's question is the wrong question. We would need to ask the adult male facing circumcision if he would wish that hundreds of thousands of other little boys, most of whom would never have had a serious problem with their foreskin throughout their lifetime, had also been strapped down to a board and had their penis surgically altered without anesthetic so that *he* might be spared a few days of controlled pain and discomfort as an adult. I can tell you, again as a psychologist, that I would be concerned about the man who would answer 'yes' to that question!

**Myth:** *It is the right of the parents, or a medical or religious practitioner, to make the circumcision decision for the infant—after all, he is only a baby.*

This is often an unspoken myth. It is assumed in our society and, so far, upheld by our courts. Many articles and books on infant circumcision not only assume the right of the parents, they are written in ways to reassure parents. In

March, 1991, AMERICAN BABY ran a feature article on infant circumcision subtitled, "It's the First Decision You'll Make for Your Son" (3). Dr. William James, a Canadian pediatrician, reassures, "...it [circumcision] seems to be a win-win situation. Whichever decision parents make it is the right decision if they're comfortable with it" (4). And, after urging that parents be better informed on the subject, Dr. Marianne Neifert concludes, "There is no right or wrong answer to the circumcision question" (5).

Dr. Aaron Fink goes further. His book, *CIRCUMCISION: A PARENT'S DECISION FOR LIFE*, not only advocates infant circumcision but implies imprudence on the part of parents who leave their son intact (6). Dr. Sherman Silber, after presenting the benefits of circumcision, nudges parents not only to act on behalf of their child but to act sooner rather than later. He intends to be

humorous: “So if a male is going to be circumcised, *he* would be wise to have it done before *he* leaves the hospital nursery” (7). (Emphasis JB)

Finally, the very act of having a parent sign a ‘consent’ form for routine infant circumcision implies that it is the right of the parents to give *their* consent for the child (soon to be a man) to undergo ‘elective’ surgery.

---

**Fact: *The male foreskin is the only organ of the human body of either sex over which parents are given such authority.***

No other healthy structure of the human body, male or female, can be amputated at the parent’s request. And, since it is impossible to diagnose any penile problem, except obvious birth defects, in infancy, no parent or doctor can know whether the particular male will ever need medical attention to his penis. We do know that the vast majority of males will not. I know of no one who would question the right of the parents to consent to necessary medical care—even when that involves really tough decisions about major surgery such as the amputation of limbs, etc. Medical necessity often dictates rather cruel and agonizing choices for parents. The routine infant circumcision question, however, is not one of those choices.

As noted above, even a pro-circumcision activist like Dr. Fink estimated that 90% of all uncircumcised males will never need surgical treatment. And in other countries the actual figures are nearer 99%. So, if *necessary* medical care is not at issue, whose body is it? Who should be allowed to choose whether or not the individual man will get to live out his life in an intact body or whether he will have his foreskin amputated? How can any parent presume to know or guess how their son will feel about this very private part of his body when he is a man? Since those functional complications with the foreskin which do occasionally occur tend to manifest themselves in later adolescence or early adulthood, the individual with a diagnosed foreskin problem is quite capable of choosing among his various treatment options and, for that matter, choosing circumcision if in his situation that seems wisest to him.

Most of us in this country are repulsed by the reports we hear of female circumcisions and clitoridectomies

performed on unsuspecting 7 to 12-year-old girls in Africa and Egypt. Some of us are equally repulsed by the custom of rounding up young males for group ritual circumcisions in Third World countries. Most of us cannot imagine living in a society where some authority could round up young men and ritually cut off a part of their body to render them acceptable adult members of society. Most of us are glad we live in a country where the law protects us from such things happening to us. Unfortunately, such things do happen in the United States of America. Every day of every year in this country over 3,000 infant males are strapped to boards against their will to have their penis irreversibly altered for life! No law protects them! No doubt the utter helplessness of the infant plays a major role in the apparent triviality of the procedure. The infant will struggle with all his might and scream with all his voice—unfortunately, no ears that really believe that he has any voice in the matter will be listening. Before long, that baby will be a grown man with legal rights, but *his* choice will have been made for him by others.

Before moving on to another issue, I would like to point out that laws are only as effective as their application and enforcement. I said above that no law protects the screaming infant strapped to a circumcision board having a part of his body cut off. Technically, that statement is not true. Virtually every state in this nation has child endangerment laws which make it a crime to put a child at undue risk. More recently, under such laws, parents who drive under the influence of alcohol with a child in their car or those who fail to protect the child by using required car seats or seat belts are being charged with crimes of child endangerment. Furthermore, in spite of our religious freedoms which we hold dear in this land, parents are being required *by law* to provide particular medical care for their ill child even



though some of the procedures violate certain of their religious convictions. And parents who believe that the Bible advocates corporal punishment are having *legal* limits set on the extent to which they can discipline their child ‘with the rod.’

There are, of course, laws potentially applicable to routine infant circumcision. These include laws designed to prevent children from being put at undue risk for trauma, injury, or death and laws enacted to protect patients from unscrupulous doctors who would prescribe or perform ‘unnecessary’ surgery. And we have already shown that the *necessity* for circumcision can *never* be demonstrated during infancy, except perhaps in rare cases of obvious birth defect. The problem, then, is not the lack of appropriate laws. It is that these laws are not seen to apply to infant *male* circumcision. Further, it seems reasonable to hope that someday baby boys will be afforded the same protection under the laws now being sought to protect little girls—even when her parents’ religious tradition calls for her to be

circumcised. If and when that happens, it will be because adults speak up for the babies whose cries have for the last 100 years fallen on deaf ears.

Finally, I would like to say that I am sure that most parents do not even think of the human rights issue when considering whether or not to have their infant son circumcised. They are making a decision that they believe they *must* make so that it can be done ‘at the right time’ if its going to be done. And, they have been assured by the system that it is their decision to make.

Only recently in this country have we begun to hear much about the rights of children to make choices for themselves. Lately, even letters to *Dear Abby* about whether or not to have a baby girl’s ears pierced have gotten a reply which suggests that the decision really ought to be left up to the girl herself (8). May I suggest that, until individuals are old enough to choose any form of *elective* surgery for themselves, *she* or *he* is too young to be subjected to any form of elective surgery!

---

**Myth:** *Circumcised men are either positive or indifferent relative to their circumcision status.*

Dr. Aaron Fink was heard to say on more than one talk show, “No man has ever complained to me about being circumcised.”

---

**Fact:** *Every time the circumcision issue is raised in public—whether by television, radio, newspaper, or magazine—thousands of letters pour in from circumcised males in every part of this nation, and now throughout the world, either just to say some of the things they usually do not dare to say elsewhere or to ask for help.*

44 years, 85% circumcised) were asked to indicate whether or not they were circumcised and to check how they felt about their circumcision status. The results were:

	<u>Circumcised</u>	<u>Intact</u>
Satisfied	38%	78%
Dissatisfied	20%	3%
Ambivalent	41%	17%

In October, 1993, MEN’S CONFIDENTIAL (MC) published an article entitled, “Reverse Circumcision,” which featured edited interviews with Dr. Charles Horton, a plastic surgeon, Dr. Ira Sharlip, a urologist, and me, a psychologist. The issue of foreskin restoration was discussed, and reference was made to this book (9). In the next issue of MC (December, 1993), the *Male Box* column began: “We received a record amount of mail about last month’s Reverse Circumcision story” (10).

Even allowing for the possibility that respondents to JOURNEYMEN may not fully reflect national norms, I believe these responses speak for themselves and may well shock many doctors and parents who are convinced that most circumcised men are quite satisfied with what was done to them (11).

In 1992, JOURNEYMEN, a men’s quarterly, conducted a survey dealing with men’s body image. Among the various issues explored, the 197 respondents (average age

Interestingly, Dr. Schlossberger and his associates, in their study of younger adolescent boys, found that, “The uncircumcised boys demonstrated less satisfaction with their status, although this did not extend to body image as a whole.” The researchers go on to suggest that, since the desire to be similar to peers typically fades in later

adolescence and adulthood, the effects of increasing age need to be studied (12). The results of the JOURNEY-MEN survey certainly do suggest very real changes with age relative to the male's attitude toward having been circumcised.

Actually, no one knows what percentage of circumcised males are pleased, indifferent, or angered by their circumcised state. No large-scale study has ever been done. It is interesting to note, however, that Dr. Fink continued until his death to say that no man had ever complained to him about being circumcised when, in fact, circumcised men phoned in to complain virtually every time he was on such a show. One wonders how personal and direct the complaint would have needed to be in order for Dr. Fink to have acknowledged that a circumcised man had indeed complained to him?

---

**Myth:** *Many less sophisticated cultures circumcise their males, and frequently their females, for reasons of rites of passage, markings, or custom; but Americans circumcise for valid medical reasons.*

In these last two chapters I have quoted many statements made by doctors who favor infant circumci-

---

**Fact:** *Doctors in America have for years also used non-medical arguments to persuade parents that circumcision was the wise option for their son.*

- In recent years, Dr. Benjamin Spock has completely reversed his original stance on infant circumcision. He is now clearly in favor of leaving the infant penis alone:

We now know that it [circumcision] is *not* the only choice, nor is it agreed that it is the most sensible choice. My own preference, if I had the good fortune to have another son, would be to leave his little penis alone (14).

However, in his 1946 book, *BABY AND CHILD CARE*, which sold tens of millions of copies in this country, he stated, "I think circumcision is a good idea, especially if most of the boys in the neighborhood are circumcised—then a boy feels 'regular'" (15). Someday all of the old, tattered copies of that early edition of *BABY AND CHILD*

Organizations such as UNCIRC, BUFF, NOCIRC, NORM, NOHARMM, V.O.I.C.E., Gulf Coast Infant Circumcision Information Center, etc., have literally thousands of letters which doctors, and others who favor routine circumcision, can read if they doubt that there are men who resent having been circumcised as an infant or a child without their consent. The comments range from, "How could anyone do that to a little baby?" to "There must be a special place in hell for those who commit this crime!" (13).

One of the more active groups, NOHARMM, was formed to give circumcised men a collective voice. NORM groups have been formed in major cities across the nation and abroad so that men who are working to restore their foreskin can exchange information and encourage one another. Believe me, men care!

sion. In each case, I have attempted to show how their statements perpetuate a particular myth about the penis or infant circumcision. So far, each of these statements has been based on *medical* opinion or reported findings. The important question relative to this myth is: What do doctors say to parents when their medical reasons have been shown to be weak or even disproved?

---

CARE will be gone. Until then, Dr. Spock is still heard, by moms and dads who got their copy from grandma, to urge them to make Junior feel *regular*.

- Dr. Martin Gershman says, "A kid, as he grows up, wants to be like his dad" (16).

- Dr. June Reinisch, Director Emeritus, The Kinsey Institute, in an April, 1994, national telecast, said, "...it's really a personal choice at this point....I think the most important thing is that a boy look like his father" (17).

It is a pity that no one shouted that message earlier in this century when several generations of us were circumcised and looked quite different from our dads! I'm sure, if dad and mom are honest with Junior, they can explain to him the advantages of having a natural penis and of being allowed to make his own decision. That is, if that has been their choice for him.

Some of you may think that I am being a bit too cryptic and sarcastic by pointing out that in this country there are only two species of mammal which are regularly altered surgically for style: dogs and human males. But, when we realize how frequently ‘matching dad’ is the reason given by parents for circumcising their new son, we are forced to acknowledge that *style* is often the major motive. And that really isn’t very different from the notion that a Boxer or a Doberman pinscher ought to have trimmed, upright ears and a docked tail to ‘look right’ and to be of show quality!

● Dr. Jerome Wolfson notes simply, “America is a circumcised society” (18).

My rejoinder to that declaration is that the situation could be remedied in *one* generation if doctors would ‘Just Say No!’

● Dr. Erlinda Alcalen has predicted, “Only those who have no money will not have it [infant circumcision] done” (19).

The geographical and socioeconomic data simply do not support this contention.

● Dr. Charles Kelley recently said, “I would not like to be a 15-year-old in the shower and be the only one not circumcised” (20).

Perhaps Dr. Kelley does not know that the current rates for circumcision and uncircumcision are nearer 50-50. Soon, the circumcised penis may well be in the minority.

Actually, Dr. Kelley does not say how he’d like to be a circumcised 15-year-old in the shower half filled with intact fellows who, in their teasing and joking, might just ‘let the cat out of the bag’ as to how great it is to have a foreskin!

● Dr. Anthony Gentile is concerned that, “Many boys are going to be teased if they look different in that way” (21).

Again, some common sense is needed. As a male who grew up in open locker rooms, I can tell you that, if we tried to rearrange every body part or feature that other children can find to tease about, we would need to arrange and rearrange our children’s bodies on a regular and ongoing basis. As a psychologist, I can assure you that it is far better to help each of our children to develop the very best body image possible and, except for treatable defects, to accept his or her body as nature provided it—warts and all. Ironically, this same advice may soon have to be taken to heart by parents who will have made their son ‘different’ by circumcision.

While I have not been able to resist replying to each of the statements above, it has not been my main intention or purpose here to show that these statements are in error. Rather, I have sought to point out that doctors can and do resort to *nonmedical* persuasion relative to this still very emotional issue.

---

**Myth:** *Those men who do resent or dislike their circumcised state are emotionally unstable and are probably in need of psychological help.*

The majority of men who have responded to the UNCIRC questionnaire indicate that they have not talked to a doctor about their feelings about their circumcised state or their desire for restoration. There are those, however, who have broached the subject with their doctor.

When asked to relate the doctor’s response, some men wrote:

“He was shocked that anyone would want restoration and refused to discuss the subject further.”

“...thought I was stupid.”

“He cut me off and talked about ‘foreskin fanatics.’”

“He laughed at me.”

“...told me I needed psychiatric counselling.”

---

**Fact:** *Many circumcised men in America and other English-speaking nations resent their circumcision. They are only now beginning to raise their voices. They are neither weird nor crazy—they are wounded.*

One man, born in 1952, wrote:

I remember *more than one* birthday, when making my wish before blowing out the candles on the cake, the wish being that, if wishes are granted, I should become uncircumcised. I was brought up in a moral but un-religious family of Christian background. I was never instructed to pray but I do remember, skeptically but seriously, praying to God (if you exist) to please make me whole again (22).

John A. Erickson has written,

There is one category of men circumcised in infancy that most books, articles and studies about circumcision don't mention and whose existence most experts have not yet acknowledged: men who see themselves as victims of a mutilation but who are silenced by the humiliation, who would rather have their foreskins intact but who cannot face the added humiliation of calling attention to the fact that part of their penis has been cut off.

They often think they are alone, and pretend contentment or indifference to save face, unaware that there are other circumcised men who have the same feelings and are pretending too.

Because they keep their thoughts and feelings to themselves, they are easy to be unaware of—and easy to ignore.

That's one of the reasons infant circumcision can seem so harmless—you rarely hear from or about the babies it eventually hurts the most (23).

How strange, we've circumcised infants so long and so regularly in this country that we've reversed *normal* and *abnormal* relative to the penis and circumcision. If an intact male grows up feeling 'different' and 'cheated,' doctors will say that they understand his feelings and will gladly cut off the unwanted part—will even shame the parents for their 'neglect' and for their part in their son's distress. On the other hand, if a circumcised male grows up feeling 'not normal' and 'cheated,' doctors will laugh at him and tell him to get psychiatric help—even though many of them could, if they chose, professionally help the individual seek restoration. The problem for the unhappily circumcised male in America is that, for the vast majority of the medical profession in this country, the circumcised penis is the 'normal penis' and the happily circumcised male is the 'normal male.'

**Myth: *Men who actively seek foreskin restoration are obsessed and mainly homosexual.***

This idea represents a 'myth in the making.' It is simply an extension of the idea that men who don't like being circumcised are emotionally unstable.

John Strand, a surgically restored male, writes,

One head of a psychiatric clinic once told me that *all men* who had a wish to be uncircumcised were paranoid, schizophrenic personalities! (24).

A recent study by Paul C. Mohl, et al., carries this abstract:

A new subgroup of patients within the homosexual community has been identified who are characterized by preoccupation with their absent foreskins. They associate their circumcised status with a sense of incompleteness,

anger over a lack of choice, and their sense of masculinity. Four patients who sought surgical reconstruction are reported. None were Jewish or psychotic. All tolerated surgery well. Preliminary etiologic hypotheses are advanced, emphasizing psychodynamic and imprinting possibilities (25).

In 1991, Dr. John Money reported the cases of five men involved with foreskin restoration. After a short biographical sketch of each subject, a brief discussion follows. It is only fair to point out here that Dr. Money's article is generally sympathetic to the idea of foreskin restoration. Yet, in his six-paragraph discussion the terms, *obsession* and *preoccupation*, appear four times each, together with a host of other terms unique to Dr. Money's psychological discipline. The very use of such terms gives the general reader the impression of pathology (26).

**Fact: *To long for something missing in one's life and to set out with determination to acquire it may be labeled either as 'having a goal' or as 'an obsession' depending on the cultural value or social appropriateness of the object sought.***

I know of no medical doctor, psychologist, or successful member of any major profession who did not have to

work 'as though possessed' to get through graduate school. These professionals were not satisfied with levels of achievement at which others settled. Rather, they worked themselves to distraction to achieve their own particular goals. When is such a goal an obsession?

My first wife died of cancer at the age of 34. A year or so before her death she had radical surgery. That surgery

involved the removal of one breast and all of the lymph nodes under one arm. After the surgery, she and I worked for weeks and months ‘walking’ her fingers up the wall above her head and marking the wall to record her progress. Her pain was so intense that she often cried, but she did indeed stretch that damaged tissue. Was she, or I, obsessed?

These days, when an individual has a face lift, a tummy tuck, a ‘nose job,’ or a hair transplant, some of us may well wonder at the amount of money the individual is willing to spend and the amount of pain he or she is willing to endure in seeking the desired results. But most of us would stop short of describing the pursuit of such accepted medical procedures in terms of *preoccupation* or *obsession*.

The major factors which set foreskin restoration apart from the more common procedures mentioned above are its lack of general acceptability and accessibility. If a circumcised male could go to a local specialist in plastic surgery and make an appointment for a foreskin restoration consultation without fanfare, he would not necessarily appear preoccupied with his condition. But, when a determined male has to write to the four corners of the nation for information and write or phone dozens of doctors to even get an appointment with someone who is willing to talk with him, he can indeed seem preoccupied, possessed—and angry!

As a psychologist, I do understand the nature of obsession—a fixation which interferes with normal daily functioning and distorts the individual’s perception of salient features of their life. And, without doubt, many objects can and do become true preoccupations and obses-

sions. I am simply concerned that we do not subject individuals to undue scrutiny or labeling simply because they doggedly seek medical help for a physical condition which they do not accept as normal even though their society has come to view it as both normal and desirable.

As far as the notion that seekers of restoration represent a ‘new subgroup of patients within the homosexual community,’ I can only say that this has not been the case for those who contact UNCIRC and other groups dealing with foreskin restoration. It may well be true that members of the homosexual community are more at ease talking about and seeking information about the penis. It may also be true that members of the homosexual community were among the first to express their pain. In this, they may well have paved the way for their heterosexual counterparts. At present, however, inquiries are received from males across the spectrum of sexual orientation. The groups I’m familiar with never ask individuals questions about their sexual preferences, but many men do volunteer such information. Actually, I occasionally receive inquiries from wives seeking information for their husband who is reluctant to make the initial contact. It is my belief that, as we make access to information and medical help for males wounded by circumcision more available, we will be astonished at the magnitude of the pain we have created in this country during this century.

Having looked in these last two chapters at the circumcision myths which are prevalent in this country, we will turn now to look at the history of both circumcision and foreskin restoration—first in the Jewish tradition and then in American society.

# 6

## The Development of Circumcision in Judaism

*“...Every male among you shall be circumcised. You shall be circumcised in the flesh of your foreskins, and it shall be a sign of the covenant between me and you.”*

**Gen. 17:10-11 RSV**

It is not my intention to write any sort of critique or exposé of either the history or the rite of circumcision within the Jewish tradition. The major focus of this book is on foreskin restoration—its history and current practices. It is not possible, however, to discuss foreskin restoration without first discussing the rite or procedure that creates the condition which calls for restoration. It is possible, of course, that males in circumcising traditions other than Jewish have also developed methods for re-covering their glans. If such is the case, I am unaware of the existence of any written documentation regarding these practices. There is, on the other hand, a clear and well-documented history of foreskin restoration among the Jews, particularly in ancient times. The very existence of this history dictates that we focus our attention on events and practices within the Jewish tradition.

Further, it is not my contention that Jewish doctors are responsible for introducing or promoting infant male circumcision as a medical practice in the United States. There is, however, an apparent procedural link between Judaism and routine medical circumcision. Of all the peoples on earth who ritualistically circumcise their young males, Judaism is the only major group which performs the rite in infancy. Early in this century, when routine male circumcision was believed to prevent an array of potentially dangerous conditions, it was also believed that infants do not feel pain in the first few days of life. Therefore, it was

the *routine circumcision of the infant male* which the American medical profession eventually espoused.

There seems little doubt that members of the medical community in this country turned for advice and example to those practitioners with the most knowledge and experience. It was, after all, Jewish mohels who had centuries of tradition and experience—including being called upon to circumcise such dignitaries as the English royal family. The most striking consequence of this rather obvious cross-pollination is the fact that the style of current medical circumcision closely resembles the results of Jewish ritual circumcision. In both instances, the glans penis is completely bared and little or no excess skin is left on the shaft of the penis. This fact is noteworthy, since most medical journals and practitioners in this country would maintain that the purpose of routine medical circumcision is simply to prevent phimosis and to facilitate hygiene. The complete denuding of the glans and the removal of virtually all mobile skin on the penile shaft are clearly not necessary to accomplish these stated purposes. It is far more likely that both the definition and the style of infant circumcision were ‘borrowed from the experts’ by the relatively inexperienced medical profession around the turn of this century.

It should be noted, however, that historically early Jews did not perform circumcision in the radical style now associated with Judaism. Ironically, it was the determined efforts of the rabbis in Roman times to stop and to prevent

the practice of foreskin restoration which brought about the radicalization of the circumcision procedure. Since the *style* of circumcision impacts greatly upon the means and ease of foreskin restoration, it is important that we trace the development of infant circumcision within the Jewish tradition.

## Origins of the Rite

The historical origins of circumcision are lost in antiquity. The DICKSON BIBLE DICTIONARY states that circumcision was practiced by the Egyptians as early as 3000 B.C. We do know that bas-relief plaques dating from about 2300 B.C. have been found in Egypt depicting the rite (1). Because of such finds, some historians have speculated that the Jews learned circumcision during their captivity in Egypt. Such conclusions are not likely, however, since (according to Bishop Ussher) the Abrahamic covenant predates Jacob's journey with his people into Egypt by some 200 years, although Abraham's wanderings had certainly taken him briefly into Egypt prior to the covenant.

If we simply follow the Genesis account, Yahweh instructed Abraham to circumcise himself and his male descendants and slaves as a sign of His covenant with Abraham. Bishop Ussher's dating would place that event at 1897 B.C. For the purposes of our discussion, however, the Jewish attitude toward and commitment to circumcision are far more significant than fixing exact dates or the origins of the idea. There is ample evidence that the Jews considered the foreskin both a curse and a fault and circumcision the means by which to remedy that fault and, thus, be worthy of God. The Book of Jubilees (xv. 26-27) states:

Whoever is uncircumcised belongs to 'the sons of Belial,' to 'the children of doom and eternal perdition' (2).

Dr. Kaufmann Kohler adds, "Uncircumcision being a blemish, circumcision was to remove it, and render Abraham and his descendants 'perfect'" (3).

There are three steps in Jewish ritual circumcision. Each of the steps was introduced at a different time in Jewish history and was intended to enhance the significance of circumcision as the "seal of the covenant."

## Milah

Milah is the first step, after prayers, of ritual circumcision. It consists of cutting off the protruding tip of the typical infant foreskin (4). Historically, this was to be done with a flint knife, certainly from the time of Joshua (5).

**The History of Milah.** The Scriptures state simply that God told Abraham to circumcise himself and all of his offspring and slaves who were eight days of age or older. And, "in the selfsame day," Abraham did it (Gen. 17:23 KJV). The act which Abraham performed was, in fact, milah—the symbolic removal of the tip of the foreskin. This relatively simple form of circumcision was practiced by the Jews for approximately 2,000 years, throughout the whole of the Old (and, for that matter, the New) Testament era. No other feature was added to the rite until sometime around 140 A.D. (6).

**The Results of Symbolic Circumcision.** The physiological results of this form of circumcision are significant to our understanding of the history of foreskin restoration. As noted earlier, the foreskin and the glans are typically fused together at birth and are actually a single organ at that stage of development. Therefore, when the ancient circumciser cut off only the protruding tip of the typical infant foreskin with a single cut, a great deal of the natural foreskin would have been left intact. Such a penis would have continued to go through its natural developmental stages. That is, the remaining foreskin would have separated from the glans naturally over time. This process would have left the glans with many of its natural features—texture, sensitivity, etc. Such a penis would also have had a rather ample remnant of foreskin. And, since the frenulum would not have been directly or intentionally destroyed, the foreskin remnant would most likely have stayed in place and continued to cover a substantial portion of the glans, particularly when the penis was flaccid. It is, indeed, this very fact which allowed 'renegade' Jews for approximately 2,000 years to effect a rather simple and convincing foreskin restoration, or re-covering of the glans.

**David's Foreskin.** There has been an ongoing, and sometimes humorous, debate over why Michelangelo's very famous statue of David has a foreskin. Surely, a man

with Michelangelo's knowledge of the male anatomy and of history would have known not to put a foreskin on a Jewish youth. Was he simply too embarrassed to chisel the more intimate details of the denuded glans? Did he consider the circumcised penis unaesthetic? Were all his models uncircumcised, and he blithely sculpted what he saw? These, and other speculations, have been raised in an effort to solve this mystery chiseled in stone.

More recently, as greater knowledge has been gained regarding circumcision practices throughout history, other explanations have been offered. A few years ago, a most compelling theory was put forward by Edward Wallerstein. After discussing some of the possible explanations noted above, he stated,

However, there is another solution and I believe I have found it. Michelangelo probably knew exactly what he was doing. First, it is necessary to examine the precise method of circumcision in 1000 B.C. [around the time of David's birth]. Originally the procedure called for removing *only* the very tip of the foreskin. Known in Hebrew as milah...

The glans of David's penis is almost completely covered by the foreskin. This factor probably prompted physicians to claim that Michelangelo sculpted the penis as uncircumcised. However, the tip of the foreskin—the preputial orifice which, normally covers the meatus (urinary opening) and usually extends beyond the glans—is ablated [removed]....In addition, the sculpting of this statue was not a hasty affair. Michelangelo labored on it for four years. We can assume that with his astute knowledge of anatomy he was as meticulous in penile details as in all others.

It is therefore probable that Michelangelo correctly portrayed David as circumcised, based upon the surgical procedure of that period—that is, with only the very tip of the foreskin removed (7).

Whether or not Wallerstein's theory about Michelangelo's David is correct, the fact remains that a male who had only the tip of his infant foreskin removed would have retained a rather goodly portion of his natural foreskin. Such a penis, when flaccid, might well appear to our American-trained eyes to be uncircumcised.

## Periah

Periah is the second step or procedure in ritual circumcision. After cutting off the end of the infant foreskin, periah consists of tearing and stripping back the remaining inner lining of the foreskin off the glans and then, by the use of a sharpened fingernail, removing all such mucous tissue including the excising of the frenulum.

**The History of Periah.** Jewish historians differ as to exactly *when* this second step was introduced into ritual circumcision. Few historians, however, disagree as to *why* it was introduced: circumcision without it was simply too easily disguised!

We will discuss the various situations in which Jews sought to appear uncircumcised and the ancient social and economic benefits of being uncircumcised when we discuss the history of foreskin restoration in Chapter 7. It is enough to say here that the rabbis sought to put an end once and for all to Jews passing themselves off as uncircumcised males by elongating the remaining remnant of their foreskin. The rabbis' solution was to so entirely obliterate the foreskin that any Jew so circumcised would not be able to disguise "the seal of the covenant."

Dr. Kohler, in the JEWISH ENCYCLOPEDIA (1964), states that "the Rabbis, probably after the war of Bar Kokba, instituted the 'periah' (the laying bare of the glans), without which circumcision was declared to be of no value." If his conclusion is correct, periah would have become universal in about 140 A.D. (8).

It is interesting to note, from an historical point of view, that by these calculations all biblical Jews—both Old and New Testament—would have been circumcised in the less radical, symbolic style of milah. This being the case, *no* biblical reference to circumcision *ever* refers to or indicates the more radical style of circumcision which is now practiced by modern-day Jews or by the American medical profession.

**The Results of Radical Circumcision.** We can be sure that the results of the new form of circumcision were relatively uniform. It was declared that if the remaining



shaft skin was excessive (any fold of skin against the corona) or if there were any ‘shreds’ of the mucous tissue left, the child was to be recircumcised. The rabbis were taking no chances! (9).

For the first time in Jewish history, the male’s glans is directly affected by the circumcision procedure. From this point on, the totally denuded and traumatized infant glans will heal with the same scarification and undergo the same keratinization process as we have described in our earlier considerations of modern-day infant circumcision. Further, the loss of all mucous tissue results in severe receptor nerve loss which, in turn, results in a significant loss of sensual sensations. This overall dulling of sensation has led some Jewish historians to speculate that circumcision was intended to curb the sexual appetite (10). Such intentions may well have been in the minds of the later Jewish rabbis who instituted periah; however, such an explanation would not hold true for the earlier, simpler style of circumcision which Jews practiced for the first 2,000 years of the covenant.

## Messisa

A variety of spellings can be found for this term: Mezziza, Mizizah, or Metzitzah. It is the third and final step in ritual circumcision. It consists of the mohel taking the bleeding penis into his mouth and sucking out the first drops of blood:

Now follows the exsuction of the wound in such a manner that the mohel takes the circumcised member into his mouth and with two or three draughts sucks the blood out of the wounded part. He then takes a mouthful of wine from a goblet and spurts it, in two or three intervals, on the wound (11).

**The History of Messisa.** This procedure was added to the ritual during the Talmudic period (around 500-625 A.D.). It was never universally adopted by all Jews, but certainly the more Orthodox Jews incorporated it into their observance of the rite. The procedure was later altered by some observant Jews who substituted a glass tube for the suction rather than mouth-to-genital contact (12). As late

as 1916, however, in New York City, mohels were threatened with loss of certification for “sucking the wound with the mouth” (13). On the other hand, in London, as late as 1961, the Initiation Society of London recommended the use of a glass tube and warned that: “One who does not perform Metzitzah must be debarred from acting as a mohel” (14). It should be pointed out that the practice of messisa has all but disappeared in the Jewish circumcision rite, although it is still reported in some ultra-Orthodox groups (15).

**The Consequences of Messisa.** In all likelihood there are no permanent effects on the physical characteristics of the circumcised penis from this procedure. There have been recorded, however, adverse effects so far as disease is concerned. In 1950, Dr. Eugene Hand, a supporter of circumcision, reported 41 cases of Jewish infants contracting tuberculosis from mohels (16). And Bryk reports an array of diseases and even deaths which are attributed to infected mohels performing messisa throughout the years (17). There seems little doubt that, among observant Jews, messisa will be the first aspect of ritual circumcision to be universally replaced by symbolic representation rather than physical compliance.

## Questions and Issues Regarding the Circumcision Rite

When a practice has had a 4,000-year history, it is bound to have raised many questions and issues and generated a fair amount of speculation and debate. Because some of these factors bear upon foreskin restoration, we should consider at least some of the more common issues.

**Why Circumcise in Infancy?** There has been a long and rather involved debate as to whether or not the Jews always circumcised their males as infants. There are some historians, including some Jews, who believe that the Hebrews, prior to their written history, circumcised young men as they were about to become bridegrooms (18). In discussing this historical issue, Moses Maimonides (1135-1204 A.D.), the well-known Jewish scholar, gives three reasons why circumcision is best done in infancy:

In the first place, if one waited until the boy grew up he might not then let himself be circumcised; in the second place, because the child experiences less pain than the adult on account of the tenderness of its skin and the weakness of its imagination, the adult fearing something before it has happened, seeing its arrival; in the third place, because the parents do not as yet love their child with fervent tenderness. That emotion has not yet been formed in the parents of which love for the child is born. For this emotion grows constantly with the sight of the child and increases in strength in the same measure as the child increases in years. Consequently, if circumcision were postponed to the second or third year, it would often be omitted entirely, due to the tender affection of the father for his child. But at its birth the love of the father, who is bound to this commandment, is still very imperfect (19).

It is of more than passing interest to our discussion that the three reasons given in the 12th century to justify infant circumcision in Judaism have distinct echoes in the issues we've discussed relative to the current practice of infant circumcision in America:

1. The figures do indeed show that the males who arrive at adulthood with their foreskin intact only rarely elect to have it removed unless they are convinced that a medical problem makes it necessary.
2. One of the major circumcision myths still prevalent in this country is the idea that newborns do not feel pain. Or, if they do, it is minor and fleeting.
3. There does seem to be a real fear that parents might not 'do the right thing' if the baby goes home from the hospital intact. This concern is clearly implied in advice which is often given by hospital staff and physicians who are committed to infant circumcision. It is the 'might-just-as-well-get-it-over-with-while-he's-here' syndrome. It does seem quite true that it is harder for parents to hand over the little guy to the circumciser after he has become *their little guy!*

**Circumcision: Health or Holiness?** The idea that Jews circumcise as much as a health measure as for reasons of faith is a very old idea indeed. It is important to note, however, that it was often historians and philosophers who made medical claims for Jewish circumcision rather than Jewish religious leaders. The Greek historian Herodotus (5th century B.C.) claimed that 'circumcision could pre-

vent penile infections' and 'supplant the need for regular washings' (20), and Philo of Alexandria (1st century A.D.) claimed that circumcision prevented disease and promoted fertility (21). Most early Jewish writers, however, rejected any idea that circumcision was performed for reasons of health. Moses Maimonides, who was also famous as a physician, rabbi, and philosopher, wrote, "No one...should circumcise himself or his son for any other reason but pure faith." He went on to say that circumcision was intended to make Jews more sexually moderate (22).

The statements of many present-day members of the Orthodox Jewish community leave little doubt as to their stance on this issue. Not only do they seek to emphasize the religious character of the circumcision rite, but they deny any medical intention at all (23).

While such a 'pure faith' stance may well be true for the more Orthodox Jew, it seems quite obvious that many modern-day Jews have taken encouragement from the prevailing attitude and claims of the American medical community relative to infant circumcision. Professor Erich Isaac notes that "Jews have been reassured and comforted by the attribution of health benefits and by non-Jewish acceptance of the rite" (24).

Perhaps it should be noted here that it is not only modern-day Jews who take comfort in the endorsement of infant circumcision by the American medical profession. Modern-day Christians are also heartened by what they perceive as 'proof that God was right all along.' Dr. S.I. McMillen, a pro-circumcision Christian doctor, in his discussion of infant circumcision among the Jews, writes:

Some people doubt the miracles by which God protected the Israelites during the plagues of Egypt, and dried up the Red Sea for their escape from bondage. Yet these miracles are small indeed compared to the miraculous, God-given directions that have saved the Israelites and others from plagues, epidemics and cancer for many centuries (25).

In America, in the current climate, it seems unlikely that even the most ultra-Orthodox Jews will be able to disentangle the "seal of the covenant" from the supposed medical benefits of infant circumcision. In spite of the protests of the purists, it seems evident that many Jews will continue to believe that they are conferring on their son both a sign and an immunity from various physical maladies when they have him circumcised on the eighth day.

**The Mohel vs. the Doctor.** The question of who ought to perform the actual circumcision, or who is best qualified to do so, is one more aspect of the health vs. holiness debate. The answer to that question often follows rather predictable lines in terms of Reform, Conservative, or Orthodox persuasion among Jews. Some would argue that only a mohel is truly qualified to administer the “seal of the covenant.” Dr. Charles Weiss reports that, “...a Philadelphia mother threatened to commit suicide upon learning that her son had been circumcised by an intern instead of ritually” (26).

While Orthodox Jews continue to use only a mohel, Romberg reports that,

Other branches of Judaism feel differently, for frequently the Bris [circumcision ceremony] is performed with a doctor doing the operation and a Rabbi officiating the ceremony with prayers and recitations. Preferably the doctor should be Jewish, but sometimes non-Jewish doctors are called upon to perform the circumcision for a Jewish Bris (27).

To complicate the issue even more, many Reform and Conservative mohels have adopted medical techniques and devices. Romberg reports:

Today most Reform and Conservative mohels have abandoned the older techniques, believing the modern clamp devices for circumcision to be safer and more humane. If a bell and clamp device such as the Gomco clamp is used, by which the small metal bell is first inserted beneath the foreskin and over the glans, then the clamp applied and the foreskin sliced off, the act of Periah is unnecessary because the bell automatically forces the glans away from the inner lining and membranes. Orthodox Jews do not believe in the use of clamp devices (because not enough blood is shed) and therefore continue to practice Periah (28).

How strange, it appears we have come full circle. The medical community now provides standards, methods, and gadgets to the tradition that once taught them the art and meaning of infant male circumcision.

While discussing the details of ritual circumcision with a rabbi acquaintance of mine, he assured me that many of the precise details demanded in earlier ritual circumcisions were no longer emphasized by modern-day mohels. And, it was evident in our discussion that the particular tools used by the mohel during the ritual were of no great interest to him as the presiding rabbi. He did not, however, indicate

that he would go so far as to endorse a straightforward medical circumcision in lieu of a ritual circumcision. And he clearly was not amenable to the idea of a symbolic naming ceremony in place of a physical circumcision.

Who actually does the best and safest job? The literature through the years is rather formidable. NEWSWEEK, in 1972, carried an article entitled “Rating the Circumcisers” (29). In it were described several mishaps which had happened as mohels performed ritual circumcisions. In 1974, PEDIATRICS carried a report by four physicians in Israel describing three cases in which mohels had applied bandages so tightly that urination was prevented (30). In 1992, Dr. Herman A. Cohen, et al., published a study done in Israel which found a significant increase in the episodes of UTI following ritual circumcision, approximately 12 days after the rite. Dr. Cohen and his associates also suspect that the traditional style of tight bandaging contributes to this increased risk, since studies of neonatal circumcision in the United States have not reported a corresponding increased risk factor (31). And, in 1994, Dr. Julian D. Eason, et al., of Guy’s Hospital, London, reported three cases of acute renal failure due to “overzealous bandaging” after ritual circumcision (32).

On the other hand, if we consider the reported mishaps and complications which are associated with nonritual circumcision (see Chapter 4), the medical profession does not necessarily have a better track record. The overwhelming historical evidence is that infant circumcisions, whether done by a mohel or a doctor, simply cannot be done entirely risk free! Human performance can never be perfect, and human tissue can never be surgically invaded without endangerment. Ultimately, it is the infant who takes the risk and who must live with the consequences of any mishap. The parents may well be dismayed, angered, or grieved. But it is the infant who is mutilated and must grow up to live out his life in a disfigured or dysfunctional body.

**Is an Uncircumcised Jew a Jew?** This question has been loudly debated during Israel’s 4,000-year commitment to the rite. Clearly, there have been periods of non-compliance. Israel did not circumcise her young during the 40-year wanderings in the Wilderness. There have also been periods of repression when circumcision was forbidden and even punishable by death (33). But even during such times, some individuals have clung tenaciously to the rite. Dr. Charles Weiss notes, “...during the Maccabean

Age [circa 200-150 B.C.] some Jewish mothers killed their sons rather than let them grow up uncircumcised” (34).

During the 1800s the Jewish Reform Movement in both the United States and Germany attempted to abolish ritual circumcision without much success, although Reform Judaism did abolish circumcision for the adult convert (35).

Today, there are once again moves by some less Orthodox Jews to eliminate infant circumcision as a necessary aspect of being an observant Jew. In September, 1990, and again in March, 1991, the Jewish press ran articles by Ronald F. Goldman which questioned the advisability of infant circumcision among modern-day Jews (36). At the Second International Symposium on Circumcision (1991), two Jewish speakers presented anti-circumcision positions from within the Jewish community. Lisa Braver Moss spoke as a Jewish mother. Her presentation focused on the basic laws in Judaism which forbid harm to be done even to animals and do not allow the human body to be altered even by tattooing. Her point was simply that Judaism itself has within its ordinances the means by which to replace circumcision by a kinder, gentler form of observance (37). Martin ‘Moshe’ Rothenberg is a Jewish educator who did not have his young son circumcised. His presentation described the alternate ceremony his family celebrated. He called it a “brit b’lee milah”—a “noncircumcision ceremony.” I noticed that he had tears in his eyes as he described the beauty of that ceremony for him and his family (38).

The Third International Symposium on Circumcision (1994) once again included presentations by members of the Jewish community which called for alternatives to physical circumcision. Moshe Rothenberg outlined the history of change within Judaism and declared: “The move away from circumcision is not a departure from the core tenants of Judaism, but instead a reaffirmation of the very values which form the foundation of Judaism” (39). Miriam Pollack, who was in Jewish education for more than 20 years and is now in private practice, presented a paper entitled: “Circumcision: A Jewish Feminist Perspective” (40). In it, she called upon “...Jewish women to question what we are doing...when we circumcise our baby boys...so that we may give voice, sanctity and blessing to the depths of our mother-knowing wisdom, which knows that to take a knife to our children’s genitals cannot be holy, even if it has been done for thousands of years.”

Obviously, the Jewish community still struggles with the rite of circumcision (41). The issues which surround the rite are highly emotional for a tradition which has withstood often grave forces for thousands of years to preserve its identity. As an outsider to that tradition, I am heartened by the voices from within. I am heartened because those of us in the non-Jewish community who oppose the mutilation of the genitals of children of either sex by the adults in their culture are sometimes accused of anti-Semitism. The voices opposing circumcision from within Judaism convince me once again of that which I know to be true in my heart—that I can be anti-circumcision without being anti-Semitic.

# 7

## Foreskin Restoration Among the Jews

*"...they also hid the circumcision of their genitals, that even when they were naked they might appear to be Greeks."*

**Josephus**

It is now well established that the Jews were not the first people on earth to circumcise their males, but it seems very likely that they were the first to devise ways and means by which to restore their foreskins. At various points in history, pressures upon the Jews to fit into the larger society have been many and varied. Some of the forces which Jews in ancient times had to contend with were of a more social nature; some of them were in the form of legislation including laws against infant circumcision which at times carried the death penalty.

We will look at foreskin restoration within the context of Israel's social and economic conditions beginning some 300 years B.C. Before doing so, however, it is important to note that the style of circumcision practiced by the Jews at this stage in their history is that of milah. As noted earlier, this style of symbolic circumcision typically left the circumcised male with a short, truncated foreskin rather than a denuded glans. All of the methods for restoring the foreskin during both the Hellenic and early Roman periods took advantage of the Jew's 'mini-foreskin.'

### **Restoration During the Hellenic Period (323-30 B.C.)**

It was the conquests of Alexander the Great which brought the whole of Jewry under Greek influence. Hellenism was the great cultural meeting and blending of East and West. The more liberal Jews frequently aligned themselves with this cultural revolution, while the more conservative, Orthodox Jews resisted. Stricter religious convictions pitted the more conservative Jew not only against the prevailing political authorities but against his more liberal brothers. At the center of such controversy and struggle was the issue of circumcision (1).

### **Men's Voices...**

"I am writing, hoping you may be able to help me. On December 26th, 1991 I will be 60 years of age, I weigh 13 stone, and I am in very good health. Being of the Jewish faith, I was circumcised by a 'mohel' as a baby. This I've regretted all my life. My non-Jewish male friends tell me that during intercourse the penis head is very sensitive resulting in extreme pleasure. I have just the opposite—a dry head and no sensitivity whatsoever. I would very much like to be referred to a surgeon in my country who would perform foreskin restoration and explain the procedure involved. This is something so personal that I feel I could not discuss this with my doctor as I am sure he would only send me to a psychiatrist. When I wake up in the morning my penis shaft feels slightly damp. This is very pleasurable, but the head is dry and nonsensitive. Now for the good news. When my penis is very limp, I have a lot of loose skin which I can then roll over the head of my penis. I am even able to get a little overhang, providing I lay on my back. I can keep the head covered for hours. If I turn onto my side, the skin just rolls back. It's then that the head feels really good, just a little moist. But unfortunately, it's only a temporary measure. I would like the head of my engorged penis covered with foreskin and have an inch or so overhang.

*(continued)*

### Men's Voices...

Not knowing very much about the uncircumcised penis, I would think it needs more looking after than a circumcised one (washing, etc.). But overall, I would think it was well worth it. When seeking foreskin restoration, would you consult a plastic surgeon, cosmetic surgeon, or a urologist? I would love to see a photograph of a penis before and after surgical restoration."

L.T., Cambridge, England

"I was raised in a Jewish home. My mother comes from a religious family; my father is basically atheist religiously though he does claim to be a Jew socially. As such, I was circumcised, as were my two brothers. None of us are religious in any way, and none of us follow any religious practice at all. I have gone one step further and have restored my foreskin, thus breaking all ties with that religion (the repudiation of circumcision is the only Jewish way to sever ties with Judaism).

Why has circumcision been an issue for me for the past twenty years? I am not sure. But I can say this. Ever since kindergarten, when I first saw a normal penis, I was aware that I was different. Even though other males were circumcised too, I just didn't feel right about it. Yet I was told that it was a religious requirement and that I should be proud of it.

In junior high and high school, taking gym and swim classes, I would see about an even 50-50 mix of circumcised and intact students. In high school on a class trip to Spain, the whole topic of circumcision really hit me. Why were none of the Spaniards circumcised and I was? I knew I was for so-called religious reasons, yet shouldn't I have had some say in what happens to my own body? Especially to my genitals? Shouldn't I have had some say in what religion, if any, I choose? Again, knowing that many others were also circumcised was no consolation because many also were not. I began growing angry. What kind of religion was this that, in this day and age, required the mutilation of my penis for membership dues? And furthermore, I person-

*(continued)*

The Hellenists were opposed to circumcision; they considered it a mark of separatism rather than the cultural blend they sought. "Hellenists spoke derisively of 'the quackery of penis-pruning,' adding angrily: 'To brag that mutilation of the flesh is proof of divine election, as if God specially loves them for it, is ridiculous!'" (2). The term, mutilation, underscores the salient point here. To the Greeks, anything that defiled the 'body beautiful' was shameful. It was considered barbaric and unnatural to alter the perfection of the human form.

### Motives for Foreskin Restoration

There were many and sundry pressures exerted upon the Jews to bring about their assimilation into the larger, Hellenized culture. Our focus here, however, dictates that we look at those pressures which brought about direct attempts on the part of more liberal or 'renegade' Jews to pass themselves off as uncircumcised members of society.

**The Search for Social Acceptance.** While the desire for acceptance no doubt brought about a variety of less obvious changes in the behavior of many Jews, it was the participation of Jewish youths in the Greek games which bears directly upon foreskin restoration (3).

The Greeks saw nothing wrong with nudity itself. The taboo, for the male, was the exposure of the glans penis. And, since the Greek games were played in the nude, the problem was how to be nude without embarrassment or, even worse, immodesty. We might say today, how to be nude without being naked. For the uncircumcised Greeks, this presented no real problem. The Greco-Roman athlete whose foreskin tended to be short enough to possibly expose his glans simply tied the end of his foreskin closed. This was done either with a 'Kynodesme' (string or muzzle) or fibula (clasp) (4). With either implement as protection, the athlete could participate without immodesty or the fear of ridicule.

No doubt there were those Greeks with a foreskin long enough that no tie or clasp was needed. On the other hand, the presence of such a precaution brought no shame or particular notice. It was by the use of these contrivances that the Jew of that day with his short foreskin remnant could participate in the games and not have his circumcision either detected or ridiculed. As long as he kept the tie or clasp fastened on his shorter foreskin in front of his glans, he was 'one of them.'

**Legal and Political Persecution of Circumcision.** The individual Jew could deal with the various social pressures toward assimilation according to the strength of his own religious convictions. Legal and political measures were quite another matter. All Jews were affected. In 168 B.C., Seleucid Emperor Antiochus IV declared Judaism illegal. He vigorously sought the Hellenization of all Jews and made ritual

circumcision a crime. Those who performed such circumcisions were to suffer,

...death by crucifixion, flogging, stoning, or devourment by wild dogs. Women who allowed their sons to be circumcised were garroted, their strangled infants strung about their necks, then hanged upon crosses as a terrible warning to others (5).

In a period of such atrocities, it is perhaps not surprising that at least some renegade Jews went even further in advocating Hellenistic values and ways. When Joshua ben-Simon and Onias ben-Joseph informed Antiochus of their desire to adopt the Greek way of life,

...they offered to sacrifice lavish sums from Temple funds in honor of the Olympian gods; and Josephus adds that when Joshua and Onias and their Hellenist parties begged and were bestowed imperial permission to build a gymnasium in Jerusalem, 'they even concealed the circumcision of their genitals so that when they were naked they might appear to be Greeks' (6).

### Early Methods of Restoration

No doubt the first Jewish athletes who tied their foreskin forward discovered that the very act of pulling and holding their foreskin in that position caused some detectible elongation. This discovery very likely led to further experimentation. And, as a result, there are at least three methods of foreskin restoration known during this period:

1. *Pulling*. Throughout the literature various methods of restoration are labeled as 'pulling.' The accounts make it clear that many circumcised Jews had a sufficient foreskin remanent such that repeated pulling or tugging on it was enough to create the appearance of being uncircumcised.
2. *Tie or Clasp*. No doubt many of the Jewish athletes discovered the enhanced results of wearing the tie or clasp on their foreskin at times other than during participation in the games. Again, their rather ample foreskin remnant would have made this method of restoration not only feasible but relatively simple.
3. *Epispasm*. This term is found throughout the literature to refer to a variety of restoration procedures. No doubt, the term came to mean any sort of 'pulling' or artificial re-producing of the foreskin. The actual term, however, refers to blistering. Indeed, some Jews would tie their foreskin forward and then apply a strong caustic agent which would blister the new tip of the foreskin. When these blisters healed, the tip and orifice of the foreskin would be scarified and constricted such that the foreskin would stay forward over the glans.

### Men's Voices...

ally never associated with or followed this religion anyway.

As a foreign language major in college, I became quite involved with foreign student groups, foreign language groups, and the like. I studied in Canada one summer with students from around the world. I also spent a semester studying in Hong Kong. As I learned more and more that hardly anyone else in the world mutilates their penises, I became enraged over mine having been cut and my being disfigured. I started reading medical journals on this topic and also began writing letters to doctors to see if this could be reversed. Most of the doctors seemed to think that there was something wrong with me. 'Why would you ever want to reverse a circumcision?' they asked. But to my happiness, a few were sympathetic.

I studied for my Master's degree at the University of Hawaii, also home of the East-West Center where students from around the world come to study. It was easy to confirm that what was done to my body was a rarity in the world. The overwhelming majority of the world's men are not circumcised. I started contacting more doctors. Again, many seemed to think I had a problem, but again a few were sympathetic. I finally found some who had experience with such surgery. The only drawback was that their methods took time and lots of money. They advised that I should only undergo such surgery if I truly felt I needed it. My problem was that, as a student, I could never afford it even if I truly needed it. But at least there was a ray of hope now.

I informed my father about my feelings. I sent him excerpts from the book, *In the Name of Humanity*, written by a Jew vehemently opposed to circumcision, whose rage was even greater than mine, if that was even possible. I advised my father not to show it to my mother because being as religious as she was, it would upset her. She ended up seeing it and became so upset with me that she stopped talking to me for six months. Eventually she advised me to seek psychological counseling. Apparently she be-

(continued)

## Men's Voices...

lieved that it was wrong for me to feel upset that my penis had been disfigured, that it was wrong for me to be angry that sexually sensitive skin had been cut off my body without my consent. Perhaps getting counseling would help me overcome my anger. But I did not want to overcome this anger. What happened to me was wrong. Period.

I returned to Hong Kong twice, once while working on my Master's and once while working on my Ph.D. At that point in my life I was identifying more with the Chinese than with any other social/racial group. I may have been doing this in part as a way to dissociate myself from those who circumcise since this practice had actually become repugnant to me. I learned that the small, now non-existent, number of Jews in Kaifeng, China did not circumcise. So why do Jews outside China continue to mutilate their children's penises, destroying the most pleasurable part of what God has given them?

...Ten years have passed since leaving school. I have not calmed down one bit. My rage is as intense as ever. I joined a support group and learned to my comfort that there are literally thousands of men out there who are equally enraged at what was done to them. And this includes Jews. I now know of several Jewish families who have refused to circumcise their sons, claiming that it is a brutal ritual whose time to end has come. I have also learned that the original Jewish circumcision did not even involve the removal of the foreskin, but only the nicking of the tip of the foreskin and the drawing of a drop of blood from it. There is no place in the Bible or in any Jewish teachings that states how much of the foreskin must be removed. Yet the total destruction of this most sensitive part of a man's body continues.

Through my support group I learned that both surgical and non-surgical foreskin restoration methods exist and have existed for as long as circumcision has been performed. Unfortunately,

(continued)

## Results of Early Restoration Methods

The results of these procedures were so convincing that Josephus, the 1st-century Jewish historian, noted that such Jews could not be distinguished from their Greek counterparts. Furthermore, the results were consistently convincing enough to cause very real concerns to the religious leaders of the Jews. Although it would take many years to accomplish, the rabbis would, eventually, put a stop to such attempts to deny the "seal of the covenant."

## Restoration During the Early Roman Period (27 B.C.-cir. 140 A.D.)

It may seem a bit arbitrary to distinguish between the Hellenic and Roman periods in so far as foreskin restoration is concerned. The Roman period, however, brought with it several significant changes for the Jews. The Roman period also brought significant changes for the Jew who sought to have his foreskin restored.

## Additional Motives for Restoration

While many of the social and cultural pressures toward assimilation which we discussed above continued to affect the Jews, some new factors made life under Rome even more difficult.

**Legal and Political Forces.** The edict by Antiochus in 168 B.C. forbidding circumcision culminated in the Maccabean Revolt (167-160 B.C.). This was followed shortly, in 142 B.C., by a period of Jewish independence. Unfortunately, that independence was short-lived, and, by the Roman period, the Jews were once again under foreign domination. In 19 A.D. political persecution culminated in a prejudicial military call-up of Jews to fight in Sardinia (7). And later, in 132 A.D., Emperor Hadrian again declared circumcision illegal and, once again, imposed the death penalty. This declaration was followed almost immediately by the Bar Kokba Uprising (132-135 A.D.). This was followed shortly, in 140 A.D., by a degree of Antoninus Pius lifting the ban on circumcision once more (8).

**Economic Sanctions Against the Jews.** In 70 A.D. Rome imposed a tax on the Jews—*Fiscus Judaicus*. This tax has been translated variously in the literature: Circumcision Tax, Temple Tax, and 'Jew Money.' By whatever name, it meant that Jews were being singled out and penalized for their status as Jews (9).

Considering the harsh consequences of circumcision for the Jew—foreign military service, capital punishment, and arbitrary taxation—is it any wonder that many who were of less Orthodox persuasion continued to seek to hide their circumcised state?



## Methods of Restoration During the Early Roman Period

In all likelihood, the three simpler methods in use during the Hellenic period continued to be used. Other methods, however, were added during this period.

**Surgical Methods of Restoration.** Aulus Cornelius Celsus (who wrote c. 14-37 A.D.) notes: “If the glans be bare, and a person chooses for the sake of decency to have it covered, that may be done” (10). He goes on to describe two different surgical methods which he employed for enhancing the covering of the glans:

1. *Deformed Penis with Insufficient Foreskin.* First, the foreskin is tied closed in front of the glans which foreshortens the penis within its skin sheath. Second, a cut is made around the base of the penile shaft just in front of the hairline. This releases the entrapped penile shaft so that the skin moves forward on the shaft toward the tie. This action creates a ring or gap around the base of the penis where there is no skin covering. Celsus then advises that lint [?] be applied to the raw flesh until a covering grows and fills in the gap. He concludes by noting that the tie must be left in place, leaving just enough opening for urination, until healing is accomplished.

2. *Circumcised Penis.* Celsus notes that reconstruction is more easily accomplished “in one to whom it is natural [short foreskin] than another, who, according to the custom of some nations has been circumcised” (11). In this method the physician makes a cut through the skin just behind the corona of the glans. When this is done, the skin is extended out over the glans in a single layer. It is important to realize that this procedure amounts to ‘unfolding’ the short foreskin, which the Jew would have had at this period, out over the glans. The inner lining of this single layer of skin would be raw, and so a poultice was placed between the glans and its new covering until healing had taken place. This surgery resulted in a single-layer flap of skin over the glans. Such a ‘foreskin’ would not have been retractable. Its value would have been purely cosmetic. Notice, again, that Celsus justifies this rather severe treatment on the basis that, “if...a person chooses for the *sake of decency* to have it covered, that may be done” (12). (Emphasis JB)

F.K. Forberg notes that the style of surgery which Celsus describes for the circumcised penis could only have been performed if the practice of periah had not as yet been introduced (13). Obviously, the Jewish value of the ‘seal’ and the Greek value of ‘decency’ were at opposite poles, each pulling on the Greco-Roman Jew.

**Additional Nonsurgical Methods of Restoration.** During the Roman period, at least two other restoration devices are documented in the literature:

## Men's Voices...

though the foreskin can be restored fairly easily and existing skin resensitized, there is no way to replace the thousands of nerve endings that were sliced off.

When I informed my parents that I had restored my foreskin, my mother asked me why I had to tell her this. She said that she did not care what I did to my body, but that informing her of it hurt her. Will she never learn that what she did to me has hurt me for 37 years and will continue to hurt me for the rest of my life? Will she never understand that the sensitive nerves and tissue that she had torn from my body can never be replaced? Will she never grasp the seriousness of this issue, that every human being has a right to his own body, and that nobody has the right to destroy any part of it without his consent?

You see, her problem is that every time I bring up any argument or make any statement against circumcision for what it is—a brutal, perverse, barbaric, dastardly savage act of sexual violence on a man's penis—she responds with such remarks as ‘there are two sides to every story’ or that I've got my facts wrong. She basically scoffs at my feelings. She refuses to truly comprehend the severity of this crime. This is a human rights issue and a child abuse issue. Circumcision inflicts pain and suffering on a child and exposes the child to an unnecessary element of risk. She argues that the religious method of circumcision is quicker and less painful than medical methods (not necessarily true), but forgets the fact that while the physical pain may last 10 seconds, 10 minutes or 10 days, the emotional pain may last forever. And even if there were no pain at all, nobody has the right to mutilate and disfigure someone else's body.”

A.Q., Portland

“I am Jewish and at 14 I attended my first and last Bris. At that time, I decided I would never circumcise any of my children. The Bris was a most traumatic experience for me. I will never forget the look on the mother's face as her infant

(continued)

## Men's Voices...

lay screaming with pain—her eyes filled with tears helpless to do anything as she paced frantically around the room.

The decision for me was an easy one, but unfortunately my relatives back east are giving me hell for it. I sent them the information I got from you, but they refuse to become educated. Dealing with them is very difficult. I had a beautiful boy on February 28th, and he will remain intact. I wish I could get my relatives to understand that the only reason to cut off the tip of my son's penis would be a religious reason. If they understood that, it would be easier. But they keep harping on me about infection and sexual pleasure. They will not listen to reason or common sense."

A.C., California

"Circumcision need not be respected in the Jewish community either, in my opinion. In fact, it needs to be challenged. I wrote an article about how my wife and I decided not to circumcise our now one-year-old son, Sammy. There is a beginning movement within traditional Jewish circles to stop circumcision."

R.P., New York

"I have read about your organization (NOCIRC). I would like to say that I give complete support to your efforts, however, I do have a serious hesitation.

It is my understanding that NOCIRC's stated goal is to stop all routine circumcisions, with the exception of those done for religious reasons. It is here that we part company. What you are saying, in essence, is that it should be okay to perform this unfair surgery on Jews and Moslems. Is that not unfair to millions of Jewish and Moslem males? Do they not have the same right as all other males to decide for themselves what is to happen to their bodies?

I was born Jewish, myself. (I was fortunate to have learned about BUFF's techniques several years ago.) What your position says is that is was okay that I had to undergo the operation when I

(continued)

1. *Penile Sheath*. It is possible that this device did not so much serve to restore the foreskin as it served to hide the circumcised penis, thus, avoiding taxation (14). "Comic actors wore a special sheath over the penis even in the bath, 'to protect the voice,' it was believed: Jews began to use the same sheath" (15).

2. *Pondus Judeaus*: The 'Weight of the Jew.' This bronze sheath, worn on the foreskin, was heavy enough to stretch the remaining foreskin to eventually re-cover the entire glans.

## Results of Foreskin Restoration in the Roman Period

There seems little doubt that the most dramatic *consequence* of foreskin restoration at this point in history was the introduction of *periah!* The rabbis had had enough, and they found a way to put a stop to "decircumcising" once and for all! In approximately 140 A.D., when the ban on circumcision was lifted by Antoninus Pius, the rabbis made the practice of *periah* universal. From that time on, no circumcision would be valid unless the entire foreskin with its mucous lining was stripped away and the glans left totally bare. Furthermore, all Jews with 'pulled' foreskins were to be recircumcised—even four or five times if necessary! (16).

There are references to the use of the *Pondus Judeaus* in Spain several centuries later (17). But whether its use at that time was for restoration or concealment is not absolutely clear. What is clear is that, after the introduction of *periah*, a Jew would never again have a partial foreskin with a functioning frenulum from which to restore a functional foreskin.

## A Final Note on Foreskin Restoration in the Roman Period

Before leaving this period of Jewish history, it is of interest to note that the Apostle Paul struggled with the issue of foreskin restoration relative to Jewish converts to Christianity. As early Christianity spread beyond its Jewish roots, there were Christian leaders in the 1st century who continued to advocate circumcision for non-Jewish Christian converts. Paul took a strong stand against such 'legalistic' practices (Gal. 5:1-6). It was Paul's intention to shift the focus of early Christianity from physical observances to a spiritual basis for the believer's faith. Thus, he wrote,

Was any one at the time of his call already circumcised? Let him not seek to remove the marks of circumcision. Was any one at the time of his call uncircumcised? Let him not seek circumcision (I Corinthians 7:18 RSV).

In Paul's day, a circumcised Jew who sought to become uncircumcised (or "decircumcised") would not have been particularly unusual. Paul's conclusion, from a Christian point of view, was 'stay as you

are!’ There is no spiritual significance either to circumcision or uncircumcision.

### **Jews and Foreskin Restoration Under Hitler (1930-1945)**

The style of circumcision at this point in Jewish history was uniformly radical. Due to the need for quick results, only equally radical, and often crude, surgical procedures of restoration were feasible.

#### **Motives for Restoration**

It hardly needs to be pointed out that the driving force behind wartime foreskin restorations was the life or death consequences. Not only were the Jews at risk, but those who helped them were also risking their life. Yet, for all of that, Polish doctors did, indeed, devise crude surgical procedures to try to help Jews avoid detection. When one examines the records of the price that some Jews paid for these services, the conclusion is obvious—the help was not always from humanitarian motives alone. While many Jewish infants were left uncircumcised for their protection, those who had already been circumcised needed another sort of disguise, and surgery was the only timely solution.

#### **Wartime Methods of Restoration**

The following accounts describing the crude surgical procedures of foreskin restoration used by Polish doctors during Hitler’s regime are from an article by Dr. Leonard Tushnet, published in the *MEDICAL TIMES*, 1965 (18).

##### **Modern Epispasm.**

The first, and crudest, technique was to pull forward the skin from behind the corona, scarify the edges roughly, and suture the scarified edges together with non-absorbable suture to create an artificial phimosis. Post-operative swelling was common and infection frequent. If infection led to scarring, the operation was successful; if however, as often happened, the sutures were extruded, the skin promptly retracted from the covered glans.

**Modern Celsus.** This method produced a non-retractable hood much like the method Celsus described for the circumcised penis.

After using local anesthetic solution sufficient to distend the loose skin behind the glans, the surgeon made a circular incision. By blunt dissection he separated the anterior and posterior portions from the underlying tissue. He then pulled forward the posterior part over the head of the glans. With absorbable suture the anterior portion was now fixed to the adjacent raw undersurface of the posterior (but now, upper) part. The tip of the remainder of the posterior portion, which now covered the glans, was narrowed by a circular suture so that retraction

#### **Men’s Voices...**

was an infant and could not speak out against it or do anything in my own defense. To be honest with you, I feel a certain resentment at that position.”

S.J. Florida

Editor’s Note: NOCIRC now opposes all infant and childhood circumcision, male and female.

did not take place. The whole penis was then wrapped in layers of gauze. If infection did not supervene, this operation was quite satisfactory from a cosmetic point of view.

**Skin Graft.** The third method described by Tushnet was the most elaborate and the most expensive. It consisted of grafting a strip of skin taken from the pelvic region into a circular cut around the penis near the glans. The graft was then folded to form the new foreskin and sutured in place near the frenulum. The two men who underwent this surgery and described it to Tushnet wished to remain anonymous. They noted only that “the wounds healed completely (‘but with rough edges’) in about two weeks.”

It should be noted here that no record has been found to indicate that any of these crude surgical methods of restoration were continued once the Nazi threat was removed.

On the other hand, we now know of a completely different wartime procedure used by Dr. H. Feriz in occupied Holland (19). What is more, the method he describes does have direct procedural links to modern-day surgical techniques. Dr. Feriz, however, does not state clearly in his 1962 article that he helped to disguise Jews in Holland, only that he performed the procedure to prevent circumcised young men from being “labeled as Jews without further evidence.” Therefore, in the absence of a clear statement relative to aiding Jews, we will wait to consider the work of Dr. Feriz in Chapter 20.

### **Jews and Modern-Day Foreskin Restoration**

Before leaving the subject of foreskin restoration among the Jews, it perhaps should be noted that the modern-day Jewish community is being made aware of the current restoration movement by articles such as, “Weighty Approach to Reverse Circumcision,” in *THE JERUSALEM REPORT*, March 25, 1993, (20) and “Uncircumcising: Undoing the Effects of an Ancient Practice in a Modern World,” in *MOTHERING*, Summer, 1994 (21). We also know that at least some doctors in Israel are aware of the reviews of this book which have appeared in a number of major medical journals. In addition, we at UNCIRC and other circumcision information centers hear from many Jewish men, worldwide, who have chosen to restore their foreskin. While these facts in no way suggest widespread restoration among Jews today, they do suggest that the Jewish community is once again confronted with the availability of restoration for those Jewish men who choose that option.

At this point, however, we need to look back at the rise of modern-day, ‘medical’ circumcision. America, along with the other English-speaking nations, had begun to experiment with circumcision both as a treatment procedure and as a preventative measure. In the next chapter we will trace the history of circumcision in America from the latter part of the 19th century to the present.

# 8

## America's 100-Year Infatuation with Circumcision

*"It (self-abuse) lays the foundation for consumption, paralysis and heart disease. It weakens the memory, makes a boy careless, negligent and listless. It even makes many lose their minds; others, when grown, commit suicide. How often mothers see their little boys handling themselves, and let it pass, because they think the boy will outgrow the habit, and do not realize the strong hold it has upon them! I say to you, who love your boys—'Watch!' Don't think it does no harm to your boy because he does not suffer now, for the effects of this vice come on so slowly that the victim is often very near death before you realize that he has done himself harm. It is worthy of note that many eminent physicians now advocate the*

*custom of circumcision, claiming that the removal of a little of the foreskin induces cleanliness, thus preventing the irritation and excitement which come from the gathering of the whitish matter under the foreskin at the beginning of the glans. This irritation being removed, the boy is less apt to tamper with his sexual organs. The argument seems a good one, especially when we call to mind the high physical state of those people who have practiced the custom. Happy is the mother who can feel she has done her duty, in this direction, while her boy is still a child."*

**THE IDEAL WOMEN—FOR MAIDENS, WIVES AND MOTHERS, Mary R. Melendy, M.D. (1903)**

For nearly a hundred years in the United States, routine infant circumcision has been the treatment of choice to 'correct' the natural state of the human male. Every other industrialized nation which introduced routine circumcision on a national scale soon abandoned it. In spite of this fact, a very large segment of the American medical community continues to recommend and defend the practice. At the present time, the infant circumcision rate has fallen below 60%, but in 1980 the rate was conservatively estimated to be 85% of all males born in this country.

Several major factors are rather easily identified as having contributed to America's near-universal belief that infant male circumcision was the only wise option. First were the startling advances in preventive medicine during the first half of this century. While most early preventive measures involved hygiene, diet, vaccines, vitamins, etc., surgical procedures were also included. Several potentially troublesome body parts, whose functions were not then well known, were deemed dispensable by the medical profession. Tonsils, adenoids, mastoids, and, of course, foreskins were routinely removed *before* they could cause trouble. In a culture which already believed that 'an ounce

of prevention is worth a pound of cure,' such precautionary 'minor' surgery was bound to have strong appeal.

Another influencing factor is the fact that America has spent a good deal of this century at war or ready for war. And war, too, has made universal male circumcision seem wise. A foreskin can prove to be a real nuisance during prolonged periods in wet trenches, steaming jungles, or desert sand without a bath or a change of clothing. As recently as 1991, a leading medical journal carried a brief commentary which alluded to possible 'foreskin-*vs.*-sand' problems during the recent Gulf War (1). Dr. Aaron Fink's response to that commentary suggested that "...the time may be at hand...to require all military service entrants to be circumcised, preferably performed in the newborn period" (2). Dr. Fink did not, however, go on to tell us by what means parents might determine whether or not their newborn son is destined for military combat. In spite of the obvious lack of logic in Dr. Fink's suggestion, combat conditions are often cited as a justification for routine male circumcision, and 'battle-ready' during this century has often meant that the recruit has had more than his hair clipped close!

Finally, America's Judeo-Christian heritage, no doubt, also played an important role in the acceptance of routine infant circumcision as the wise thing to do. Given this country's reputation for diversity and as a melting pot, it is always startling to see the results of polls taken relative to basic religious beliefs. Over and over again the polls show that a high percentage of Americans believe in God and that there is a wide acceptance of the fundamental tenets of Judeo-Christian teachings. More recently, a 1988 poll published in LIFE magazine reported that 80% of those polled agreed with the statement: "Even today miracles are performed by the power of God" (3). With such belief systems in place, it is predictable that cross-validation between religious beliefs and the field of modern medicine will be reassuring. Obviously, most Americans do not practice routine infant male circumcision as a religious observance. Still, since God at one point commanded it *and* the American medical profession largely recommends it *and* the United States military has so 'strongly advised' it, it must be the wise thing to do!

The acceptance of routine infant circumcision for the male is actually the culmination of a long and sometimes tragic history of medical experimentation which began before the turn of this century. To gain perspective, it is important to note that, when circumcision was introduced as a treatment procedure, it was *not* limited to males. And it was *not* typically performed in infancy. Rather, it was seen as a 'cure' for a variety of maladies and as a means by which to curb undesirable behaviors in 'afflicted' individuals of both sexes. This earlier history of circumcision and related procedures in the late 19th and early 20th centuries reads like something out the works of Marquis de Sade.

### Victorianism in the Late 19th Century

Those human passions which Puritanism did not kill, Victorianism repressed. Puritanism has been described as 'the haunting fear that someone, somewhere, is having a good time.' If one adds to this earliest American heritage the stifling effects of Victorian manners and attitudes, it is predictable that the perceived 'dangers' inherent in human sexuality would be seen to demand radical measures. A brief array of quotes from before the turn of this century is sufficient to indicate the social mood of the time.

As early as the 18th century, the effects of masturbation were described by one writer as follows:

...One of the two men who indulged in excessive masturbation became insane; the other dried out his brain so prodigiously that it could be heard rattling in his skull....The effects of masturbation range from impotence to epilepsy, and include 'consumption, blindness, imbecility, insanity, rheumatism, gonorrhea, priapism (painful continuous erection due to disease), tumors, constipation, hemorrhoids, female homosexuality, and finally lead to death' (4).

Since none of the then-known and tried treatments seemed to 'cure' masturbation, it is further predictable that the treatment procedures would become increasingly punitive—after all, something had to finally bring this evil under control!

In discussing 'treatments' for masturbation, Berkeley notes:

By about 1880 the individual...might wish [to]...tie, chain, or infibulate sexually active children...to adorn them with grotesque appliances, encase them in plaster, leather, or rubber, to frighten or even castrate them...masturbation insanity was now real enough—it was affecting the medical profession (5).

Karen Ericksen Paige, in her article, "The Ritual of Circumcision," notes:

Some doctors recommend covering the penis with plaster of Paris, leather or rubber, cauterization, making boys wear chastity belts or spiked rings, and in extreme cases, castration (6).

Into this social climate, circumcision was introduced as yet another measure by which to treat and hopefully cure masturbation. No doubt circumcision's growing status as a valid medical procedure gave this 'treatment' added credibility:

In 1891, James Hutchinson, president of the Royal College of Surgeons (in Great Britain), published a paper 'On Circumcision as Preventive of Masturbation'; in it he not only advocated circumcision for the treatment and prevention of this 'shameful habit,' but proposed that '...if public opinion permitted their adoption...measures more radical than circumcision would...be a true kindness' (7).

Two years later, in 1893,

...Another British doctor wrote 'Circumcision: Its Advantages and How to Perform It,' which listed the reasons for removing the 'vestigial prepuce.' Evidently the foreskin

could cause 'nocturnal incontinence,' hysteria, epilepsy, and irritation that might 'give rise to erotic stimulation and consequently masturbation' (8).

## **Surgical 'Treatments' for the Male Masturbator**

Dr. P.C. Remondino published a detailed book in 1891 entitled *HISTORY OF CIRCUMCISION FROM THE EARLIEST TIMES TO THE PRESENT: MORAL AND PHYSICAL REASONS FOR ITS PERFORMANCE*. His own list of titles and accomplishments is impressive:

Member of the American Medical Association, of the American Public Health Association, of the San Diego County Medical Society, of the State Board of Health of California, and of the Board of Health of the City of San Diego; Vice-President of California State Medical Society and of Southern California Medical Society...(9).

For all his training and service as a physician, his view of the foreskin seems to echo primitive superstition far more than a medical point of view:

...The prepuce [foreskin] seems to exercise a malign influence in the most distant and apparently unconnected manner; where like some of the evil genii or spirits in the Arabian tales, it can reach from afar the object of its malignity, striking him down unawares in the most unaccountable manner; making him a victim to all manner of ills, sufferings and tribulations; unfitting him for marriage or the cares of business; making him miserable and an object of continual scolding in childhood, through its worriments and nocturnal enuresis; later on beginning to affect him with all kinds of physical distortions and ailments, nocturnal pollutions, and other conditions calculated to weaken him physically, mentally, and morally, to land him, perchance, in the jail, or even in a lunatic asylum. Man's whole life is subject to the capricious dispensations and whims of this Job's-comforts-dispensing enemy of man.

Remondino then goes on to note that one, Louis A. Sayer, was to medicine what Columbus was to geography because he "annexed" this vast field of knowledge—the foreskin and its evils—so that medicine, through its skills, could "modify" its evil influence! Throughout his very long discussion which follows, the presence of the foreskin and the habit of masturbation are inextricably linked (10).

**Circumcision as a Treatment Procedure.** In 1895, Dr. Edgar J. Spratling noted that, for the treatment of masturbation in the male,

...circumcision is undoubtedly the physician's closest friend and ally....To obtain the best results one must cut away enough skin and mucous membrane to rather put it on the stretch when erections come later. There must be no play in the skin after the wound has thoroughly healed, but it must fit tightly over the penis, for should there be any play the patient will be found to readily resume his practice not begrudging the time and extra energy required to produce the orgasm....We may not be sure that we have done away with the possibility of masturbation, but we may feel confident that we have limited it to within the danger lines...(11).

Until its 1940 edition, one of the standard American textbooks on pediatrics, Holt's *DISEASES OF INFANCY AND CHILDHOOD*, condemns the practice of masturbation as medically harmful. R.A. Spitz notes: "In the early editions, the treatment recommended is mechanical restraint, corporal punishment in the very young, circumcision in boys even if phimosis does not exist '*because of the moral effect of the operation*'" (12). (Emphasis JB)

**Castration and Penile Amputation as Treatment Procedures.** It is conceivable that America actually gravitated toward routine circumcision as a 'kinder and gentler' option compared to other surgical treatments for masturbation. Wallerstein notes,

Initially, the surgery [circumcision] was performed much more frequently on upper-class rather than lower-class infants, to prevent masturbation and hypersexuality. Considering that masturbation and hypersexuality were treated by such horrible means as penile amputation and castration, circumcision was a relatively mild form of therapy (13).

## **Surgical 'Treatments' for the Female**

Circumcision and other surgical adjustments to the female genitalia have never been as popular in the United States as elsewhere in the world. The fact that female genitals have been less regularly assaulted than those of the male in the United States may simply be a reflection of our cultural lore that 'little girls are made of sugar and spice and everything nice,' while 'little boys are made of snips and snails and puppy dog tails.' Nevertheless, females in this country have not altogether escaped the surgeon's 'treatment' procedures.

**Female Circumcision.** Many people in the United States—males and females alike—are totally unaware that female circumcision exists. They are unaware that

any such procedure was ever practiced in this country or that various forms of the procedure are still routinely practiced, particularly in various African nations, including sectors of Egyptian society, and along the Persian Gulf and the southern part of the Arab Peninsula.

In these and other cultures, there are several degrees of severity and styles of female ‘circumcision’ which have been practiced and are still being practiced today. The removal of the prepuce and the tip of the clitoris (Sunna) is the mildest form of female genital mutilation currently practiced. A more severe form of female circumcision (excision/clitoridectomy) includes the removal of the clitoris and often adjacent parts including the labia minora and sometimes all exterior genitalia. The most severe procedure is that of infibulation—after excision, the raw edges are sewn together with gut, thread, or thorns and the girl’s legs are bound together until healing is completed. This more radical form of circumcision guarantees virginity until the vagina is reopened by forceful penetration if possible or by cutting, typically the night before the bride’s wedding or on the wedding night by the husband (14).

In America, various ‘treatments’ to the clitoris and adjoining areas have been practiced as medically recommended procedures. Such treatments to the clitoris include a circumcision procedure more directly analogous to male circumcision; that is, the hood (foreskin) over the head of the clitoris (glans clitoridis) is surgically reduced or removed to expose the glans. Such clitoral circumcision is described as follows:

After an injection of novocaine the doctor uses a 4-inch forceps to pull back the prepuce, makes a small 1/2-inch slit in it, and removes the elliptical piece of skin...however...the inner lips serve as a protective shield for the clitoris and if too much is removed it could leave the clitoris dangerously exposed (15).

**Medical Treatments for Female Masturbators.** The same textbook on pediatrics by Holt which recommended circumcision in boys, “...advocated female circumcision, cauterization of the clitoris, and even blistering of the vulva and prepuce for recalcitrant (female) masturbators” (16).

**Circumcision to Reduce Sex Drive.** As late as 1936, an American doctor quite seriously suggested in a medical publication that women who were more passionate than their husbands be circumcised to *reduce* their sex drive

(17). This suggestion seems to have been calculated to preserve the ‘sugar and spice’ myth. I have found no follow-up data to indicate whether or not the procedure achieved the desired results.

**Circumcision as Treatment for Nonorgasmic Women.** During the 1950s it became somewhat popular to circumcise the clitoris of nonorgasmic women in an effort to enhance sexual arousal. One doctor who performed such circumcisions wrote:

‘Women can have a redundancy (excessive amount of tissue) and phimosis (inability to retract) of the prepuce...’ and advocates the operation: ‘1) If the patient is adipose...this operation may help cure her adiposity (fat) by relieving psychosomatic factors, 2) If the husband is unusually awkward or difficult to educate, one should at times make the clitoris easier to find. [!] 3) If the clitoris is quite small and difficult to contact’ (18).

**Routine Infant Female Circumcision.** In the 1950s at least one doctor advocated infant circumcision for the following conditions:

...The infant clitoris is hidden. The prepuce covers it at birth. The midline raphe invariably is intact...It may remain intact into late multiparous life...When the raphe does not open, smegma accumulation can cause trouble. Moreover, if the raphe opens only a pinpoint bacteria can enter to cause contamination of the debris. Then come the symptoms of irritation, scratching, irritability, masturbation, frequency and urgency. In adults, the same conditions exist, with associated smegmaliths that may cause dyspareunia [painful intercourse] and frigidity. If the male needs circumcision for cleanliness and hygiene, why not the female?...The same reasons that apply for the circumcision of males are generally valid when considered for the female (19).

While reading the statements above, it is not at all difficult to hear exact parallels to the common arguments for infant male circumcision. And yet, while America has enthusiastically agreed to alter her little boy babies, she is repulsed when the same suggestions and justifications are offered relative to her little girls.

**Love Surgery.** In 1988, the media publicized the case of Dr. James C. Burt who performed a so-called “love surgery” on his female patients. The alleged surgical techniques included circumcision, rotation of the vagina away from the bladder and internal genitalia, and the



extension of the vagina to align it with the clitoris. A further allegation was that the surgeries were often performed without the patient's knowledge or consent. The case against Dr. Burt received a great deal of notoriety. Thirty-three women came forward to say that the surgery had ruined their life and made normal sex relations nearly intolerable or impossible. Lawsuits were filed, and the entire issue was brought before both the State Medical Board in Ohio and the courts. Dr. Burt was charged with gross immorality and banned from surgical practice in November, 1988 (20). And, in June, 1991, a jury awarded one of his victims \$5 million (21).

Before leaving the subject of Dr. Burt's "love surgery," I would like to say that I am in full agreement with the actions of both the courts and the medical board involved in this case. The thing I do not understand, however, is how these mutilated women got such immediate sympathy, understanding, and action! Their complaints echo the hundreds of letters received from circumcised men mutilated at birth or in early childhood without their consent who as adults are sexually impaired or dysfunctional. When such men seek professional help they are often laughed at and ridiculed. Neither the courts nor the appropriate medical boards care to come to their defense as individuals or to take steps to correct a routine practice which regularly leaves a certain percentage of its patients permanently damaged for life. The medical profession seems just to say, 'Oops! We'll try to do better next time.' Why isn't such a practice and its sometimes tragic results also labeled "gross immorality"? Surely it is just as wrong to surgically alter a male's body sexually without *his* consent or permission and to put him at risk for sexual dysfunction as it is to do such things to a female—age not withstanding!

## Preventive Medicine

The history of routine infant male circumcision in America is intertwined with the development of the field of preventive medicine during the first half of this century.

**Historical Development.** As early as 1857 work was done by Louis Pasteur, and soon after by Robert Koch, a German physician, relative to the germ theory of disease. By the turn of this century, the transmitting agents for a

host of diseases had been discovered. The practical results of these discoveries was a steady decline in deaths due to infectious diseases. The practice of immunization was introduced in 1885, and antitoxin inoculations soon followed. Literally thousands of lives were saved in World War I when tetanus antitoxin inoculations became available.

Further, by the turn of this century, most of the larger cities in the United States had water purification systems. Milk was required to be pasteurized in 1909, and in 1912 the knowledge of vitamins and their role in nutrition was introduced. With these developments, the focus of the medical profession shifted from treatment only to more regularly include disease prevention.

To be sure, since before the dawn of history, man relied on charms, amulets, and talismans to ward off disease. And some of the older folks among us can recall asafetida bags and garlics hung around their neck. But, by the dawn of the 20th century, the medical community offered a growing array of medicines and procedures which were designed to protect the individual from various diseases in advance of infection or malfunction.

**Nonsurgical Preventive Measures.** Most recommended prophylactic measures incorporated newly discovered facts about diet, nutrition, and hygiene. These ranged from simple measures of cleanliness to such procedures as the routine addition of certain vitamins to common foods to combat the newly discovered consequences of deficiencies of particular vitamins. Included in these treatment procedures was a growing number of vaccines which offered protection from a variety of otherwise potentially deadly diseases. By the 1930s and 40s, it was rather naively assumed that we would someday soon have a vaccine for virtually every known disease.

**Surgical Preventive Measures.** By mid-century, children in this country could expect to spend at least part of a summer or two recuperating from various surgical procedures which were considered sensible precautions against possible future problems. Tonsils, adenoids, mastoids, often appendix, and, of course, male foreskins were removed *en masse*. These routine procedures have since all fallen by the wayside, except for the amputation of the male foreskin—'inoculation by amputation.' That procedure not only continued; it flourished!

## The Reputation of the Foreskin in America

No doubt circumcision would have fallen by the wayside along with the other surgical preventive measures if it weren't for the fact that the foreskin itself had been portrayed as such an enemy to health and cleanliness. Earlier in this century, circumcision as the procedure which ridded the male of this natural curse hardly needed to be questioned. In 1910, Dr. S.L. Kistler of Los Angeles published an article entitled "Rapid Bloodless Circumcision of Male and Female and its Technic" in the *JOURNAL OF THE AMERICAN MEDICAL ASSOCIATION*. In that article, Dr. Kistler described a circumcision clamp device he had designed: The Phimosis Clamp. Before discussing the clamp device, Dr. Kistler notes:

The necessity for circumcision is abundantly evidenced, and although it may be needless to state any reasons for doing this operation, nevertheless I will mention a few:

1. Reduced tendency to convulsions in infancy arising from irritable nervous system.
2. Habit of masturbation not so likely to be formed.
3. Lessened irritability of child or adult.
4. Amorosity reduced.
5. A hygienic condition promoted.
6. Venereal diseases not so readily contracted, and consequently:
7. Fewer pelvic diseases in women.
8. For impotency in old men, as has been advocated (22).

With such misinformation being channeled to the American public, is it any wonder that the foreskin got such a bad reputation?

**"You Just Can't Keep a Foreskin Clean."** Hygiene continues to be the most frequently mentioned 'problem' with having a foreskin—a problem usually mentioned by men, and women, who do not have one. The culprit is, of course, *smegma*. If some members of the medical community were to be believed, we could expect large volumes of 'filthy' smegma to be oozing from under normal foreskins at such a rate that males cursed with a foreskin would be virtual social outcasts. Dr. S.I. McMillen describes smegma as, "a filthy and foul-smelling paste of bacteria and dead cells trapped under the foreskin" (23). Actually, no single organ of the human body produces as much smegma as the

more external portions of the female sex organs. Smegma is, in fact, simply discarded skin cells combined with the natural moisture of mucous tissue—the 'dandruff' of the sex organs. Obviously, intact males, as with females, must practice good habits of hygiene in order to avoid undue bacteria collection and an unpleasant odor.

**"A Foreskin Has an Odor."** At least this charge is true. In common with the female sex organs, the intact penis has a unique and natural odor. If the intact male wishes to maintain a freshness of odor he will need to rinse under his foreskin in much the same manner as females must rinse to avoid a dank or unpleasant odor. There have been periods in this country's history when rather harsh douches were suggested for female hygiene. Today, however, most gynecologists would recommend gentle rinsing of the outer female sex organs with little or no douching. A similar recommendation is appropriate for the intact male. Proper hygiene involves simply rinsing the penis with clear water or mild soap while the foreskin is retracted. Such a simple procedure does not seem very involved nor time consuming. Surely irreversible surgical amputation of a healthy body part to relieve the male of such a daily task must be a blatant case of overkill!

**"We Don't Like That Kind."** In America, a foreskin can cause the intact male another kind of problem: prejudice. Attitudes and remarks about the natural penis can be a painful problem for these men and boys. An acquaintance of mine, while discussing the fact that one of her young grandsons is circumcised and the other is not, cocked her head to one side and said, "well I know which one I prefer!" She went on to say that, to her, the natural penis looks 'funny.' Imagine growing up with a grandma who thinks your body looks funny and is unattractive because it has been left in its natural state. As noted in Chapter 5, dogs and human males are the only two species of mammal which we in America regularly alter surgically for style—contouring ears and docking the tail in the one species and amputating the foreskin in the other.

Occasionally, at UNCIRC, we hear from intact males who relate some of the remarks and attitudes they have encountered. In locker rooms, other males have teased, "When are you going to get rid of that baby skin and become a man?," or "It looks like an anteater." Women have made remarks such as, "Is that thing clean?"; "I'm

sorry, but I don't like foreskins"; "It's ugly"; "I can't touch you because you are not circumcised"; "Get it cut!"; and "Real men are circumcised" (24).

Such remarks by women reveal not only a national bias but an interesting imbalance in human rights issues in this country. If a male were to insist on some surgical alteration in his fiancée—breast augmentation or reduction, liposuction, a nose job, etc.—before he would *touch* her intimately, he would be considered a male chauvinist and beneath contempt by most women. And yet, there are more than a few cases on record in which men have had themselves circumcised because a fiancée refused to marry him unless he did.

Prejudice is always destructive. Having one's person attacked because of natural facts of birth—whether the object of ridicule is skin color, hair color, big feet or nose, or a normal foreskin—is painful. The idea that an individual could be expected to have his body surgically altered in order to gain social acceptance or love ought to be thoroughly unacceptable in this the decade of the 90s.

**“It's Got to Go!”** The many myths which have grown up around the foreskin and circumcision have been discussed at length in Chapters 4 and 5. Let me just summarize this discussion about America's most common attitudes toward the foreskin by noting that we, as a nation, decided quite early in this century that, since the male foreskin was such an enemy to health and happiness, it had to go! And, since it had to go, the sooner the better! And, thus, it came to be: Infant Male Circumcision became an American institution. And, typical to American ingenuity, we have refined and honed our circumcision skills. We have taken a once primitive initiation rite done with a sharp stone and carried it to the brink of the 21st century with laser beam technology!

### **The Style of the Typical American Penis**

The American penis is not a fact of nature. It is man made! And its style has varied somewhat over the years as 'improved' methods and devices for performing circumcisions have been introduced. Many circumcised men are curious about their own circumcision, both to know how it was done and what caused them to have particular features and the overall style of circumcision they have grown up with. Style, in terms of the amount of remaining shaft skin, is of particular interest to men who are considering foreskin restoration by the nonsurgical 'stretching' method.

Conceivably, medical concerns relative to possible phimosis and the need for penile hygiene would be served by any of a number of less radical procedures—stretching exercises, the dorsal slit, partial circumcision, etc. But American doctors tend to bare it all! This fact is somewhat dictated by our insistence on *infant* circumcision. If too much raw skin is left behind, the excess can bunch up around the corona of the raw infant glans and reattach to create skin bridges or adhesions. This problem could be avoided, of course, by careful attention during the healing process. But, then, that would defeat one of the major purposes of circumcision—to render the penis absolutely maintenance free. For this and other more psychological reasons, we seem to want that little penis skinned tight. That way, the little skinned-tight penis will grow up to be a big skinned-tight penis with no smegma, smell, or maintenance needs.

In the next six sections of this chapter, we will trace the prevailing techniques and implements introduced and used in the successive decades of this century. Since individual doctors select their own technique and device, and often continue to use their favored methods throughout their practice, this chronology can only provide a very rough guideline. When, however, the year of one's birth is combined with certain telltale features of one's circumcision, it is often possible to make a rather educated guess as to the procedure which was used.

### **Early Freehand Methods of Circumcision**

American doctors launched the infant circumcision era armed only with a scalpel or scissors, forceps, and sutures. With only these simple implements at hand, they were truly free to be creative.

**The 'Intact' Circumcision.** UNCIRC has heard from a small number of older males, and even a few younger ones, whose doctors were apparently not altogether comfortable with routine circumcision. These doctors did not *cut off* anything. They stripped the foreskin off the glans and usually clipped the frenulum (and some did a dorsal or ventral slit) so that the now-dysfunctional foreskin would remain retracted behind the glans. Males who have undergone such procedures have relatively little difficulty retraining such a foreskin to remain in place over the glans, once they realize what has—or hasn't—been done to them.

**The ‘Original’ American Standard.** Typically, the doctor began the procedure by inserting a probe between the glans and the foreskin. The probe was then used to break or tear free the connective membrane (synechia) which typically connects these structures at birth. This done, the doctor grasped the newborn’s foreskin with forceps and stretched it out beyond the glans as far as it seemed appropriate. He or she then lopped off the ‘right amount’ of the foreskin which released the remaining shaft skin to pop back behind the glans to about the ‘right spot.’ The doctor then rolled the freed inner lining of the foreskin off the glans and retracted it back to meet the raw edge of the shaft skin. The two edges were then stitched together to form a continuous shaft covering, and the penis was left to heal.

It is not my intention to be overly derisive in the description above. The procedure was simply not more precise than that. Throughout such free-hand procedures there was a series of judgment calls, any one of which could prove tricky or even disastrous. Dr. Elliot Grossman notes:

One of the problems encountered by ‘free hand’ circumcisors, those who used no clamping device, was a cosmetic one. The operator would exert an even pull on the prepuce as he began to excise it, but as the incision lengthened, the tension exerted was no longer evenly distributed. As a result, the last piece of tissue cut was pulled outward more and so the incision at the frenulum was often deeper and uneven. Healing was delayed and the cosmetic result was often poor (25).

The most obvious result of such methods is a rather prominent scar, often including stitch marks and, in some cases, stitch tunnels. It was clearly inevitable that, if infant circumcision was to continue on a grand scale, more precise methods would need to be developed. Americans do not struggle along for very long with cumbersome ways and means. The assembly-line mentality is just too much a part of us. Inventive attempts to establish circumcision standards and produce uniformity were just around the corner.

## America’s Tools of the Trade

The American’s love of the ‘proper’ tools, whether they be gadgetry or precision implements, is a well-known national trait. Drawings for devices of every description

swamp our patent offices. The field of medicine is certainly no exception, as even a brief tour of the Smithsonian Institute will attest. It was inevitable that the need for more control during infant circumcisions would spark invention, and circumcision tools specifically designed for use in the hospital nursery quickly began to appear.

In 1982, Dr. Elliot Grossman published a book entitled, *CIRCUMCISION: A PICTORIAL ATLAS OF ITS HISTORY, INSTRUMENT DEVELOPMENT AND OPERATING TECHNIQUES*. This book is not for the faint of heart! There are 18 pages of pictures and brief descriptions of “modern” tools and devices introduced from 1920 to 1972. The devices are discussed under the headings: “Forceps,” “Bell Technique,” and “Flat Shield Technique” (26). If one did not know that it is a medical textbook printed in the last decade, the implements could easily be mistaken for examples of ancient torture devices found in some museums. We will discuss in detail only two of the modern-day devices: the Gomco Clamp and the Plastibell. Their combined use, no doubt, accounts for the technique employed in the vast majority of circumcisions done in this country since the mid-1930s.

## The Probe

Before discussing modern-day technology, it seems appropriate to at least mention the earliest instrument introduced to streamline the circumcision procedure: the probe. This implement was first mentioned in the 18th-century writings of Rabbi Jacob Emden:

There are some (circumcisors) that have an instrument similar to a long thick silver needle with a blunt point, to test if the skin is attached to the glans, and they use it to separate them with this needle. This is a good precaution that is not harmful and is not painful [!?] (27).

The probe was originally introduced as a measuring device to ascertain the length of the foreskin to be excised. In the process of inserting the probe back to the corona in order to measure the foreskin, it was discovered that moving the probe from side to side broke the natural bonds or membrane (synechia) attaching the inner lining of the foreskin and the glans. This separation, before the actual circumcision was performed, made the entire procedure easier. Today, according to Grossman, its use is virtually universal (28). Not only is the probe used in most medical circumcisions but increasingly in ritual circumcisions as

well. S. Levin, M.B., stated in 1965 that "...it is becoming more common for the properly trained mohel to first free the prepuce from the glans by means of a probe..." (29). And Henry C. Romberg, physician and mohel, reported in 1985, "Almost all the mohalim with whom I spoke used a probe as a regular part of their procedure" (30).

## The Gomco Clamp

Historically, this "bell technique" device warrants full attention. It was introduced in 1935 and has remained unchanged and in wide use to date. Dr. Grossman states:

The Gomco Clamp is the most widely used circumcision instrument. *The introduction of this clamp* by the Goldstein Manufacturing Co. (Gomco) and *the development of the 'bloodless technique'* by Yellen in 1935...*have done much to encourage neonatal circumcision.* [Emphasis JB] They made the operation safer, reduced the chance of infection and practically eliminated hemorrhage...The Gomco Clamp is made up of four parts: a plate, a stud (bell), an arm (yoke), and a nut (to tighten the clamp) (Figure 8-1) (31).

Several clamp devices, some with protective bells and some flat, were introduced after 1935, but none gained the wide acceptance of the Gomco Clamp. Clamp devices which crush the skin in an attempt to stop bleeding typically do not require the use of sutures. The use of such devices often results in a rather brownish stripe around the penis in place of the more prominent scar of the freehand method. The Gomco Clamp remains the most widely used circumcision device.

## The Plastibell

This disposable device was introduced in 1965 by Hollister Inc. It utilizes a concept used by some indigenous peoples. Among these people, the young boy being circumcised wears his foreskin tightly tied around a reed in a manner which 'strangles' the foreskin until it begins to slough off. He then sits in a stream and allows his foreskin to be washed away and carried downstream by the water. While the concept may be the same, the material and the design of the Hollister device are, of course, quite different.

Dr. Grossman explains:

The Hollister Plastibell is a disposable plastic bell with a grooved edge. This bell is inserted into the prepuccial cavity

and the prepuce is tied around it with a tight surgical tie cutting off the blood supply to the prepuce. The top of the bell is broken off, so that the patient may urinate. After several days, the prepuce necroses and falls off, with the plastic bell. The bell remains tightly tied around the glans during this process. Reports of oozing, poor results, as well as the appearance of the necrotic process itself, leave much to be desired. Also, the tied stretched skin exerts a force pulling the bell against the glans. There are reports of the bell working its way onto the penile shaft, and there is at least one report of a permanent induced sulcus formed on the glans itself...the Plastibell is the only disposable circumcision instrument that is currently widely used (Figure 8-2) (32).

Men born after 1965 will have somewhat more difficulty distinguishing between the results of various clamp devices and those of the Plastibell. I am told, however, that the wider, brownish stripe which frequently results from clamp devices are not common with the Plastibell. Again, neither the Gomco Clamp nor the Plastibell require the use of sutures except when it becomes necessary to repair areas which have separated or become septic.

## The Advent of the Circumcision Board

In some hospitals infants are still kept from wriggling by an assistant. Dr. Grossman describes the procedure as follows:

...the patient may be held by an assistant who sits behind the patient's head. He grasps the patient's knees with his thumb and three fingers, and after placing his arms below the patient's shoulders, pulls slightly to abduct the thighs (33).

In the 1990s, however, most infant circumcisions are done with the infant strapped to a circumcision board. One of the most common of such devices is the Circumstraint, manufactured by the Olympic Medical Corp., Seattle, Washington. It comes complete with Velcro straps to immobilize the infant's knees and elbows. It is further designed so that the infant's genitalia are elevated for easy access, and there is a platform between the infant's legs so that various circumcision equipment may be supported (34). I was told, in 1991, by a representative of the manufacturer that the company had been marketing this device for approximately the last 20 years (Figure 8-3).

### The Gomco Technique

1. Stretch the preputial opening.
2. Break preputial adhesions\* so that the foreskin is completely retractile (A).
3. Retract the foreskin until you can see the corona. Check the glans for any hidden adhesions\*. If the entire preputial space is not free, you stand a good chance of pinching the glans on the bell or clamp, or of leaving adhesions\* behind.
4. Apply a small amount of lubricant such as K-Y jelly to the glans so that it won't stick to the inside of the bell.
5. Apply the bell-shaped plunger over the glans. The bell should fit easily over the glans so that it covers the corona. Too small a bell may injure the glans and fail to protect the corona. If stretching the preputial opening does not allow the bell to be inserted in the preputial space and entirely cover the glans, a dorsal slit may be necessary. (B)
6. Pull the prepuce up over the bell. The foreskin should not be stretched or pulled too snugly over the bell. If it's pulled up too tightly, it's possible to remove too much shaft skin or to pull the urethra up so you get a tangential cut through the urethra as well as the skin. (C)
7. Judge the amount of the shaft skin left below the corona; the skin should be relaxed and supple.
8. After you're sure of the dimensions, apply the plate of the clamp at the level of the corona. (D)

9. With everything in proper alignment, tighten the clamp. This squeezes the prepuce between the bell and the clamp to make it blood-free. Be sure the weight of the clamp doesn't distort the anatomy so there isn't the proper amount of skin in the clamp.
10. Make a circumferential incision with a cold knife, not an electrosurgical instrument. (E)
11. Leave the clamp in place at least five minutes to allow clotting and coaptation to occur.
12. Remove the clamp and apply antiseptic ointment (Betadine) to the crush line. Apply a light dressing or loin cloth arrangement to keep the ointment from rubbing off.
13. If you remove the clamp prematurely, the crushed edges may separate and bleeding will occur. When this occurs, suture the mucocutaneous margin, being careful to avoid deep sutures that might penetrate the urethra. If the whole edge separates, treat as a freehand circumcision, placing quadrant sutures and sewing between them with fine stitches.
14. Have the baby watched overnight for any sign of bleeding.
15. If late separation occurs, it's best to keep the wound clean and let it heal secondarily rather than to try to suture it and risk development of stricture or fistula. Skin of this area tends to re-epithelialize rapidly.

\*A tragic misnomer, since the foreskin is almost always naturally attached to the glans at birth (editor).

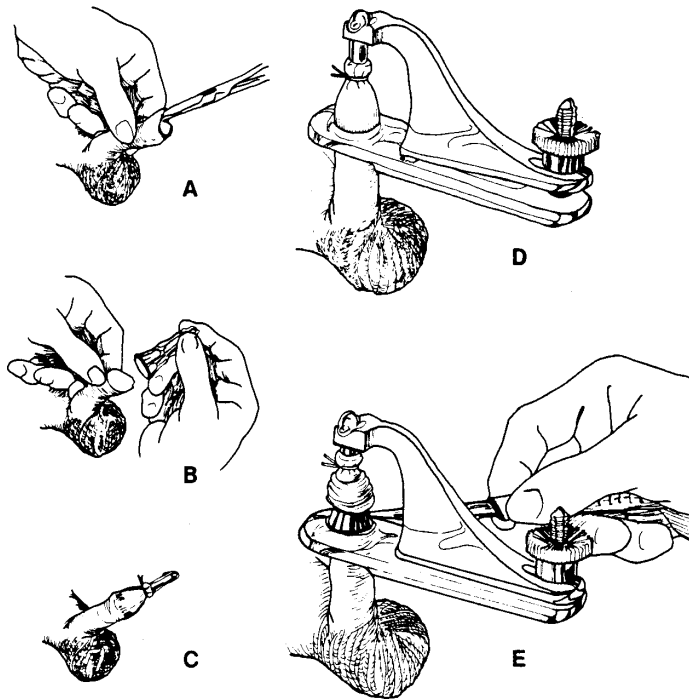
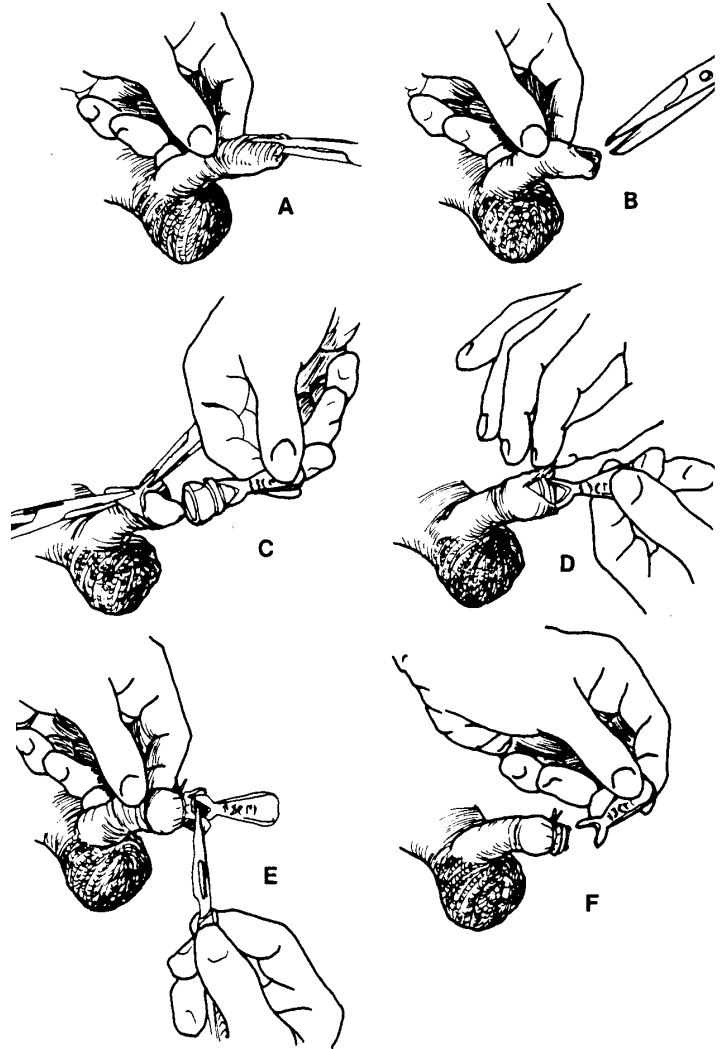

Figure 8-1 The Gomco technique of circumcision (Adapted from PATIENT CARE, March 15, 1978)

### The Plastibell Technique

1. Stretch the preputial opening.
2. Break preputial adhesions\* with a probe or closed forceps.
3. Make a small dorsal slit of 0.5 to 1.0 cm in the prepuce. Keep the initial slit short; it can always be extended. To minimize bleeding, previously crush the line of incision with artery forceps for one minute. Take particular care not to place forceps or scissors in the urethra meatus; before cutting or crushing, lift the prepuce away from the glans and visualize the meatus. (A,B)
4. Separate the edges of the slit with a pair of artery forceps to reveal the glans. If necessary, extend the cut to expose the coronal sulcus. (C)
5. Free any remaining adhesions\* and lay the prepuce back (inside out) to expose the entire glans.
6. Slip the Plastibell of appropriate size over the glans as far as the coronal sulcus. It should slip over the glans easily; too small a bell may injure the glans.
7. Place the prepuce over the bell to hold it in place. (D)
8. Tie the ligature as tightly as possible around the prepuce on the ridge of the bell; oozing will occur if the ligature is loose.
9. After one to two minutes to allow for crush, trim off the prepuce at the distal edge of the ligature, using a knife or scissors. Trim as much tissue as possible to reduce the amount of necrotic tissue and possibility of infection. (E)
10. Snap off the handle of the bell, leaving the bell and ligature in place. You should be able to see an unobstructed urethral meatus. (F)
11. No dressing is necessary; the baby may be bathed normally; the rim of tissue under and distal to the ligature will become necrotic (dead) and will separate with the bell in 5 to 10 days.
12. Occasionally, edema will trap the plastic ring on the shaft of the penis. In this case, it's usually necessary to cut off the ring, using a guide and ring cutter, although application of ice will sometimes reduce edema enough to remove the ring.



\*A tragic misnomer, since the foreskin is almost always naturally attached to the glans at birth (editor).

Figure 8-2 The Plastibell technique of circumcision (Adapted from PATIENT CARE, March 15, 1978)

As I review Dr. Grossman's book and these last sections of this chapter discussing circumcision tools, devices, and equipment, I can only hope that the day will soon come when all of this inventive creativity will be turned to more worthy causes. The world does indeed need instruments of healing; we surely are not in need of more

instruments of destruction! The Old Testament prophet envisioned a day when,

...they shall beat their swords into plowshares, and their spears into pruning hooks....they shall sit every man under his vine and under his fig tree, and none shall make them afraid...(Micah 4:3&4 RSV).

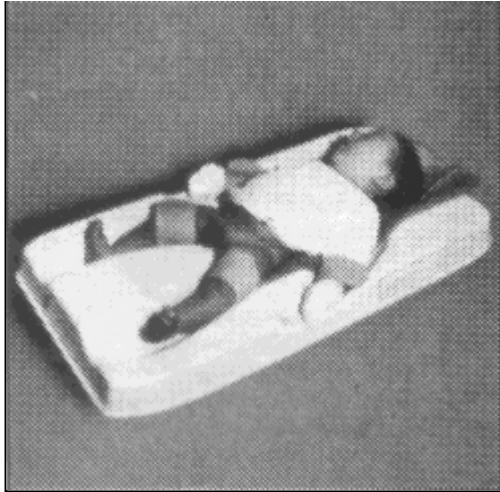

Figure 8-3 The Circumstraint (Mfr's brochure)

I wonder what we could beat the weapons of circumcision into so that every baby boy born in this country, or for that matter on this planet, will be bound only in his parents' arms and none shall make him afraid?

## The Results of a Successful Circumcision

This is a difficult concept to define. What is a successful circumcision? Those who favor infant circumcision would point out that the vast majority of routine circumcisions fall into this category. I suspect that the definition of 'successful' depends, at least partially, upon whether we look at the results from a medical or a personal point of view.

**Successful from a Medical Point of View.** These are the most obvious criteria: 1) There should have been no serious physical or medical problems resulting from the procedure. 2) The penis should still look normal, by American standards. 3) The circumcision should in no way interfere with normal urination or erections. 4) The individual should be able to achieve normal ejaculations.

**Successful from the Circumcised Male's Point of View.** This is a different set of criteria than those described above. Some of the features which circumcised males complain about would, in all likelihood, not be considered of great importance by the medical profession.

When a typical intact male has an erection, he has enough skin covering his penis so that the skin is virtually

unstretched. That is, the thickness and the mobility of the skin on his penis does not significantly change from the flaccid to the erect state. The typical circumcised penis, on the other hand, not only utilizes all of the available skin on the penis but often stretches it to such a point that it becomes taut and somewhat translucent. Movement which forces mobility of such taut skin is often uncomfortable rather than sensual. Males with such a circumcision often must use a lubricant for any sexual activity because there simply is no free mobility of the penile covering.

Further, as discussed in Chapter 2, the denuded glans is toughened both by scarification and by constant exposure and daily friction against clothing. Such a glans may not provide the circumcised male with nearly enough sensitivity to be sexually satisfying, especially as he gets older.

Taut skin during erections and a dull glans may cause the circumcised male to complain that, from his point of view, his circumcision is not successful. These 'ordinary' conditions would not, however, cause most doctors to question the success of a particular circumcision.

## Minor Mishaps—Oops!

The conditions described in this section really are so common that they must also be considered within the range of 'successful.' I've made a distinction, however, because these conditions are definitely unintentional and are truly 'mishaps.' Although, once again, the medical profession does not take them very seriously.

**Too Little Skin.** If it seems like we just talked about this subject under 'Successful Circumcisions,' we did. That's because there's 'too little,' and then there's 'TOO LITTLE!' Recently, a 24-year-old male came to talk to me about restoration procedures. He was interested in the 'stretching' method using tape. After I had explained the entire procedure, he said, "But what do you do about the hair?" Thinking he meant the possible nuisance of getting the tape caught in his pubic hair, I said, "Some men find it helpful to clip the long hairs enough to keep them out of the way." "No," he said, "what about the hair on your penis?" "Oh," I said, "some men clip the few hairs off the underside so that removing the tape won't pull them." "No," he said, "I mean, how do you stick tape to the hairy part of your penis?" Actually, I wasn't understanding his questions at all. It seems that this young man has pubic and



scrotal hair growing thickly on the shaft of his penis right out to the circumcision scar, which is approximately midway out the shaft of his penis. He really does not have any typical shaft skin left on his penis at all.

This young man's condition may simply have resulted from an over-zealous doctor removing far too much shaft skin, or it could be the result of an anatomical condition with which he was born. Occasionally, a male is born with a penis which is completely surrounded by scrotal tissue. That is, the penile shaft extends *through* the upper-most portion of the scrotum rather than above the scrotum as is normally the case. Such a penis in an adult has hair growing much further out the penile shaft than would typically be found. If, however, the male with such a penis is left intact, there is generally ample shaft and foreskin tissue to provide a smooth and hairless penile covering when the foreskin is retracted and during erections. On the other hand, if such a male is circumcised as an infant, the result is typically the loss of any shaft skin he might have developed and, as an adult, hair growing out on his penis to the circumcision scar. Obviously, there is no visible hair line on an infant to help the doctor recognize this condition and, thus, avoid a particularly unwise circumcision. The very fact that this congenital condition does occur with some degree of regularity is just one more reason for leaving the infant penis alone!

**Bent or Angled Penis.** There are two diseases which cause the penis to angle. Peyronie's Disease causes either a twisted angle (35) or a sharp upward curve upon erection (36). It is caused by scar tissue of unknown origin. The other disease is called Chordee. This is a congenital condition which causes the glans to bend down at a 90%, or more, angle. This is a true structural abnormality which requires surgery to correct if the condition is severe enough to interfere with intercourse (37). The bends and angles which I am referring to here are not, however, caused by such conditions. They are the result of circumcision and are caused by the combination of too much skin removed and an uneven cut. The bend can go in whatever direction the greater amount of skin or flexibility allows. This condition can cause difficult and even painful intercourse—for both partners. Urologists are frequently called upon to treat the more severe cases.

The following exchange between Dr. James Gilbaugh and a reader appeared in MEN'S HEALTH in December,

1991. In light of our discussion, several points are of interest:

*Dear Dr. Gilbaugh:*

*Since my teenage years, I have been concerned about the shape of my erect penis. Instead of being straight or slightly curved toward my abdomen, it curves downward in an arch from the base to the tip.*

*Finally, at the age of 32, I consulted a urologist who informed me that the problem was not Peyronie's disease or chordee, but the result of an incorrectly performed circumcision that has caused the frenulum to miss the midline of my penis by approximately 1/4 inch.*

*Without promising a complete correction of the curvature, the urologist circumcised me again, and the result is a slightly straighter penis. However, the downward arch is still present on erection, and I am still concerned....*

The doctor's reply:

It is very encouraging that the urologist you consulted was able to partially correct your curvature. If he has determined that you do not have Peyronie's disease or chordee, it's likely that your original circumcision *was* the cause.

If you are really unhappy with the appearance of your penis after the corrective surgery (or concerned that your penis is still not 'correct'), go back to the urologist and see if he feels additional surgery is appropriate....

However, if you have no pain and if your penis functions properly for sex and urination, I would suggest that you simply leave it alone. No one's penis is *perfectly* straight, and it's quite possible that you may be wishing for more than nature is willing to provide (38).

**Stitch Tunnels.** Obviously, these rather tiny tunnels occur when sutures have been used and accidentally left in place under the skin during the healing process. The small, often double-ended, sinuses fill with oily residue and sloughed cells which are eventually extruded like a black-head.

**Skin Bridges.** These structures are the result of the incision (the scar) coming into contact with the raw infant glans—typically near the corona. When this contact is of a long enough duration, the surfaces heal together forming a skin bridge. Some of these tissue structures are quite small, but I have seen pictures of at least one case where the bridge was large enough to slide a lead pencil through it (39).

**Skin Tags.** This term is used to describe an odd assortment of uneven bits of skin which somehow get left behind during the circumcision procedure. Frequently,

they are tabs of skin which protrude or dangle from the circumcision scar. In describing the use of some of the “modern” circumcision devices, Dr. Grossman noted that certain ones of them are more apt than others to leave “dog ears” behind which require further “trimming” with scissors. Obviously, not all such remnants are noticed by the doctor.

**Pitted Glans.** When the connective membrane is torn, while stripping the foreskin from the glans, it is expected that the tear will be clean. Such is not always the case. In some instances, the foreskin takes with it hunks of the glans, leaving behind a pit, or pits, in the surface of the glans. Such pits can be rather shallow, or they can be deep and unsightly.

When I have occasion to talk with circumcised males who assure me that they have no negative feelings about being circumcised, they often express doubt that the conditions I’ve described in this section actually exist—or that they exist in any great number. These men often rejoin, “I’ve never seen any of these things.” Actually, they may well be right; they’ve probably never seen them. Over and over, men with these surgical mishaps who respond to our questionnaires indicate that they are embarrassed to be seen nude and avoid situations where they might have to be undressed in public. Many of them indicate further that they avoid public urinals because of their embarrassment. Therefore, it is probably true that most men in America have never seen these conditions, but it is not because they do not exist!

## Complications of Difficult Circumcisions

Thankfully, complications of difficult circumcisions are rarer, but, when they do occur, they are more tragic. In Chapter 4, under “Risks of Circumcision,” hemorrhage, infection, surgical mishaps, healing mishaps, and even death were discussed. Obviously, some of these conditions are treatable and leave no visible consequences. Others, however, leave the individual with a deformed or even dysfunctional penis for life. Regrettably, there are innumerable articles in the medical literature which describe in great detail the tragic results of severe surgical mishaps.

No matter how much any pro-circumcision activist has tried to minimize these risks or trivialize the emotional and

often physical pain of circumcised men, their continuing commitment to this nation’s madness astonishes me. Why the people of any nation would want to go on regularly producing such tragic and sad by-products of a procedure which the rest of the industrialized nations of the world have long since abandoned, I cannot fathom. When will common sense prevail? In the words of an old army adage: “If it ain’t broke, don’t fix it!”

## Circumcision and the Abnormal Penis

One very real problem with any standardized routine is the risk of overlooking the exceptions—tragically so, in the case of routine circumcision. In a 1993 article entitled, “The Inconspicuous Penis,” Paul S. Bergeson, M.D., et al., listed seven abnormal conditions which fall under that general term. For some of these conditions, circumcision is particularly contraindicated, and, if done, it results in the loss of valuable foreskin which could have been useful in subsequent repair of the original anomaly (40). One of the seven conditions, buried penis is an infrequent congenital penile deformity in which the penile shaft is buried below the surface of the prepubic skin due to an abnormally prominent fat pad. If the condition goes unrecognized and a circumcision is performed, the consequences may be serious indeed (41).

Obviously, the full range of congenital conditions which may make a ‘routine circumcision’ result in tragedy is well beyond the scope of this book. It is, however, especially frightening to realize that the combination of a junior staff member—so often charged with doing ‘the circs’—and an unrecognized congenital condition may result in a compounded tragedy for a male already faced with an abnormality which will in most cases require surgical correction.

At the beginning of this chapter, I noted that Christians in America are often reassured by the medical profession’s validation of a procedure which their God at one time commanded—and some would still say *introduced* to the human race. There seems little doubt that modern-day evangelical Christianity in America has had a very strong influence in both the adoption and the continuation of infant male circumcision in this country. In the next chapter we will look at this uniquely 20th-century phenomenon in American Christianity.

# 9

## Twentieth Century Christianity and Infant Male Circumcision in America

*“If we are in union with Christ Jesus circumcision makes no difference at all, nor does the want of it; the only thing that counts is faith active in love.”*

**Gal. 5:6 NEB**

So far, in our consideration of religious influences relative to infant male circumcision, we have focused on the role and history of circumcision within the Jewish tradition. We have not, as yet, considered in any detail the role of Christianity in maintaining America’s commitment to the practice. Unlike Judaism, Christianity’s endorsement of the circumcision of the infant male is a 20th-century phenomenon. To be sure, there were Jewish converts to early Christianity who continued circumcision as an adjunct to their Christian faith. It was, in fact, this faction within the 1st-century Church with which the Apostle Paul, in so many of his writings, took issue. And, there has always been a small, but sometimes vocal, group within Christianity who favor incorporating various tenets of Old Testament teaching in order to justify a more restricted life style for the Christian.

### **The Dawn of a New Christian Attitude Toward Male Circumcision**

If one sets aside the exceptions noted above, Christianity largely ignored the subject of physical circumcision of the male for nearly 2,000 years. During those centuries, the Old Testament era was viewed by theologians and laymen alike as a symbolic preparation for the life and work of Jesus Christ and Old Testament law as symbolic depictions of the sacrifice he was to make for the salvation of mankind.

Then, at about the turn of this century, a very interesting phenomenon took place. Modern medicine began to come of age. The role of the doctor, as well as that of the entire field of medicine, changed dramatically. The priest and the minister rather suddenly found themselves competing with the doctor in terms of giving advice and counsel in matters of health and even life style. It does not seem overly unkind to note that modern medicine at that point in its history began to take on a rather god-like aura, certainly where issues of life and death were concerned. I, for one, grew up in a strict religious home where the word of the minister and that of the doctor were treated with equal, albeit somewhat different, respect.

**The Challenges of Modern Medicine to the Christian Faith.** Nowhere within the broad scope of 20th-century medicine is its power and influence more apparent than in the field of preventive medicine. Diseases which were seen at one time as most likely terminal, and often as an act of God, were re-examined in light of new discoveries and rendered both treatable and preventable. It was, therefore, to modern medicine that Americans increasingly looked for relief from their suffering and cures for their diseases. Unfortunately, for the American male, preventive medicine early in this century incorporated the practice of routine infant male circumcision. This fact is especially unfortunate because it set off a counter-reaction within large segments of the Christian community.

No one should minimize the reaction by Christianity in America to the medical field's claims for routine infant male circumcision as a preventive health measure. That reaction not only helped to establish and legitimize the procedure but has worked to retain it long after claims of medical benefit have been successfully challenged and the practice set aside in the rest of the industrialized world. The overwhelming reaction among American Christians, not unlike that of some Jews, was a rather smug, 'We told you so!' 'Our God has always been right.' 'You just think that you discovered a good thing.' 'We've known about it for centuries.' It was indeed a kind of 'anything you can do, our God has always done better,' or, at the very least, 'our God said it long before you did!' The medical profession was simply not going to be allowed to upstage God!

**The Old Testament as Medical Prescriptions.** For the first time in 2,000 years, mainstream Christianity began to look with new eyes at Old Testament teachings. If infant male circumcision was the 'right thing to do,' what about other Old Testament ordinances? By mid-century, the trend was set. Old Testament law would take its place in modern-day Christianity in the guise of medical prescription. The book, *NONE OF THESE DISEASES*, by the Christian physician, S.I. McMillen, now in a second edition, is based entirely on the premise that God revealed to Israel advanced medical knowledge in the form of ritual law in order to protect them from disease:

After God led the Israelites out of Egypt, He promised His people that if they would obey His statutes, He would put 'none of these diseases' upon them. Was this a trustworthy promise? Could submitting to a code of 'restrictive' rules lead to freedom from sicknesses? Could this promise remain pertinent even in the twentieth century?

Yes! Medical science is still discovering how obedience to the ancient prescriptions saved the primitive Hebrews from the scourges of epidemic plagues; and medical research is constantly proving the timeless potency of the divine prescription for modern diseases. Yes! Obedience to biblical precepts is still the most effective way to prevent many of the afflictions of mankind (1).

The foreword to the second edition of Dr. McMillen's book notes that over one million copies have been sold and that it has been on best-seller lists in the United States and Canada since it was first published in 1963. Not surprisingly, each edition of the book devotes an entire chapter to the 'wisdom' of infant male circumcision.

In 1991, Pastor Dan Gayman published a pamphlet for the Church of Israel, headquartered in Schell City, Missouri, entitled, *LO, CHILDREN...OUR HERITAGE FROM GOD*. In it, he presents infant male circumcision as God's directive not only for the male's health but for his morality and his spirituality. According to the teachings in this pamphlet, the Christian male should be circumcised on the eighth day because, among a very long list of touted benefits,

Circumcision will have positive affects in helping to reduce lust in men. Circumcised males tend to be less promiscuous than uncircumcised males (2).

The claim that the Old Testament contains medical prescriptions in ritual form has been disputed among Jews for centuries. More Orthodox Jews have tended to reject such claims out of hand, particularly where circumcision, the "seal of the covenant," is concerned. Recall the words of Moses Maimonides (1135-1204): "No one...should circumcise himself or his son for any other reason but pure faith" (3). Other Jewish writers, however, including Josephus in the 1st century, have insisted that male circumcision has both hygienic and medical benefits.

Christians claiming health benefits for male circumcision as prescribed by Old Testament law is, on the other hand, a much newer phenomenon. While it seems clear that these 'Christian' claims have come about largely as a reaction to the growing dominance and authority of 20th-century medicine, such attitudes and claims have become common throughout modern-day Christianity. For instance, Pat Robertson, the TV evangelist who ran for president in 1988, has stated, "If God gave instructions for His people to be circumcised, it certainly would be in good judgment as God is perfect in wisdom and knowledge" (4).

## A Careful Look at Old Testament Law and Ordinances as Medical Prescription

It is my deep conviction that, if an all-wise God gave his people advanced medical knowledge in the form of ritual law, we can expect to find *each and every* such ordinance dealing with human food consumption, hygiene, or treatment of the body to be medically sound by modern standards. It is not my intention to make light of the Jewish law and traditions which I will cite. I merely contend that they are better understood as religious observances in terms of

the “seal of the covenant” and symbolic purity and sacrifice than as medical prescriptions.

**Food: Clean and Unclean.** Selection, preparation, and cooking of both produce and animals for food must follow strict ordinances in order for virtually any such substance to be “clean” and, thus, suitable for human consumption. Further, for a living creature to be clean, it must possess certain anatomical features.

1. *Mammals.* For a mammal to be clean it must have cloven hoofs and chew a cud (Lev. 11:3). By these distinctions, rabbit, pig, bear, and a host of smaller animals are “unclean.” As an aside, it is hard to imagine America’s western migration without diets which relied heavily on such “unclean” creatures.

2. *Sea Life.* To be clean, aquatic creatures must have fins and scales (Lev. 11:9). By these distinctions, lobster, shrimp, shellfish, squid, etc., are all “unclean.” One only has to consider the fact that the entire Orient has thrived on diets rich in these forbidden foods to know that such foods do not threaten the existence or life expectancy of a people.

3. *Mammals Dead of Natural Causes.* A clean animal which dies of natural causes is “unclean” to Israel. It can be, however, sold for food to a foreigner or fed to the “stranger that is in thy gates.” God’s explanation for this apparent inconsistency: “you are an holy people unto the Lord Your God” (Deut. 14:21 KJV). Notice that this prohibition has nothing to do with the quality of the meat but of the uniqueness of God’s people.

4. *No Blood or Fat to be Eaten (Lev. 7:23-27).* One might well argue that a diet low in fat intake is indeed a healthier diet. We would know today, however, that simply avoiding visible fat in meat while not limiting the intake of meat itself nor of such foods as dairy products and eggs will not necessarily result in a low fat intake. If, indeed, God intended this prohibition to medically protect his children, he could have written a far more precise prescription! As to the eating of blood, nearly every major nationality in our Western heritage has some sausage or pudding made from blood. And, as a people, we have survived to the point of overpopulating the globe.

Again, it is not my intention to make light of Jewish law nor to argue the merits of killing animals for food as opposed to vegetarianism. I am simply pointing out that “clean” *vs.* “unclean” as applied to mammals in the Old Testament is based upon symbolic and obedience considerations rather than the suitability of a particular creature for human consumption.

5. *Fruit from Young Trees.* Fruit from such trees in the Promised Land was not to be eaten until the fifth harvest. And, until the third year, “...ye shall count the fruit thereof as uncircumcised” (Lev. 19:23 KJV).

6. *Earthen Vessels.* Such a vessel is to be broken and discarded should a “creeping thing” fall into it. When that happens, the vessel is rendered *permanently* “unclean” (Lev. 11:33).

7. *Preparation and Cooking Laws.* A host of Kosher laws has grown out of the single, simple Old Testament ordinance: “Thou shalt not seethe [boil] a kid in his mother’s milk” (Exodus 23:19 KJV). Humans can indeed extrapolate God’s word!

**Human Conditions: Clean and Unclean.** Several human conditions render the individual “unclean” [untouchable] and in need of redemptive cleansing. Indeed, without the appropriate cleansing, the status of unclean is permanent (Numbers 19:20).

1. *Contact with the Carcass of an Unclean or Forbidden Creature.* If the individual makes such contact, he or she is to wash their clothing and remain unclean until the evening (Lev. 11:25&28).

2. *Contact with a Dead Person.* Contact with a dead body, or bone of a man, or a grave renders the individual unclean for seven days. On the third day and the seventh day the individual is to be sprinkled with a mixture of running water and the ashes from a burnt offering by a “clean” person. The individual is then to “...purify himself, and wash his clothes, and bathe himself in water, and shall be clean at even” (Numbers 19:11-19 KJV).

3. *Menstrual Flow.* During menses the woman is declared unclean for seven days. She is not to be touched and anything that she sits or lies on is rendered unclean. If during her flow, her husband is touched

with her flow he too is unclean, as is the bed upon which he lies, for seven days. There follows then sacrifice and cleansing in order to restore purity (Lev. 15:19-33).

4. *Seminal Fluid.* When a male has an ejaculation he is to wash all his flesh in water and be unclean until evening. If his fluid gets on any garment, it is to be washed and be unclean until evening. After intercourse, both the man and the woman are to bathe themselves and be unclean until evening (Lev. 15:16-18).

5. *Childbirth.* If the woman bears a male child, she is declared unclean for seven days and is barred from consecrated things for 33 days. If she bears a female child, she is declared unclean for 14 days and is barred from consecrated things for 66 days. There follows sacrifice and purification rites to restore her to the status of “clean” (Lev. 12).

Clearly, none of these ordinances reflect modern-day medical knowledge or attitudes concerning the various functions of the human body or its fluids. The states of “clean” *vs.* “unclean” relative to the human body are clearly determinations dispensed by God to teach symbolic lessons of purity and uniqueness as a people and, particularly, obedience relative to God’s authority. When the Apostle Peter argued with God in a vision over clean *vs.* unclean relative to certain foods, God’s words to him were clear, “What God hath cleansed, that call not thou common” (Acts 10:15 KJV).

**Symbolic Markings of the Human Body.** Judaism contains clear and definite prohibition against body markings, even tattooing. There are, however, two exceptions to this prohibition within Jewish law itself.

1. *Ear Marking.* When an indentured Hebrew servant had fulfilled his seven-year obligation, he was free to leave the household of his master. If, however, he chose to remain in his servitude, he could give himself to the master. When he did so, the master was to take him to the doorpost and drive an awl through his ear lobe to mark him as a self-indentured slave. Such a contract was binding until the death of the master or the Year of Jubilee (Exodus 21:6, Deut. 15:17).

2. *Circumcision of All Newborn Males on the Eighth Day.* As noted in Chapter 6, Jews practiced only the

simple, symbolic removal of the tip of the infant male foreskin (milah) for approximately 2,000 years as the “seal of the covenant.” Except for the rare case of congenital phimosis, such a symbolic marking would hardly have afforded a male so circumcised any of the so-called hygienic or medical benefits claimed for modern-day radical circumcision.

**A Further Look at Old Testament Circumcision as a Hygienic Measure.** It has been suggested by some Christians (and some Jews) that circumcision is just one more of the means by which God provided hygienic protection for his children, particularly during their desert wanderings. What many Christians do not realize, however, is that Israel did not circumcise her male infants during her 40-year wanderings in the Wilderness (Joshua 5:4&5). When this fact is looked at, together with the effects of God’s judgment upon the unbelieving congregation of Israel, a very interesting fact emerges. Remember, as a judgment, God detained Israel in the Wilderness until the last of those who had come out of Egypt had died, except the two faithful spies. This all means, then, that the males who were circumcised just as they entered the Promised Land were up to 40 years of age and were fathers and even grandfathers at the time of their circumcision.

If, as some suggest, God conceived infant male circumcision as a protective health measure, doesn’t it seem rather strange that he risked not only the health of the individuals born in the Wilderness but the very propagation of the new generations who were to claim the Promised Land? In light of all the stringent requirements God imposed upon Israel in the Wilderness and all the lessons of obedience he taught them, why would he have allowed virtually every male in the congregation of Israel to remain uncircumcised until they arrived at the very border of the new land? Was their circumcision as they crossed over the Jordan into the Promised Land a matter of health or symbolic holiness?

What about New Testament teachings relative to Old Testament law? Christianity has always had to strike a delicate balance between conviction, dedication, and observance on the one hand and ‘Pharisaism’ on the other. The Pharisees, you will recall, were a particularly pious sect of Jews who were quite prominent at the time of Christ. Their tendency to ‘out-holy the Holy One’ brought sharp rebukes from both Christ and the Apostle Paul. Modern-day Christians ought certainly to be struck by the dramatic

changes which the Jewish rabbis have made through the ages in the circumcision rite. We know historically that it was an attempt on the part of the rabbis to force lifelong compliance which resulted in the current, more radical style of circumcision. Actually, it was not until 140 A.D. that the male glans was “laid bare” (periah) by Jewish circumcision (5).

Given these facts, the spirit of Pharisaism should certainly be suspected by Christians schooled in New Testament teachings. Once the Christian acknowledges that Old Testament circumcision was physically a very different act from the circumcision we know today, it is relatively easy to see it *only* as the “seal of the covenant” as God intended it. And, once that realization is firmly grasped, the Christian can once again, after nearly a hundred years of confusion, hear clearly and distinctly the words of the Apostle Paul:

Circumcision is nothing and Uncircumcision is nothing...  
(I Cor. 7:19 KJV).

And nothing means *nothing*! The Apostle Paul was very capable of hair-splitting deliberation on a whole range of subjects. Had he needed to qualify or clarify his teachings on circumcision so that Christians would only do it for health reasons and not for supposed spiritual benefits, I have every reason to believe that he would have been far more detailed and precise in his writings. What he did say is that it is *nothing*, and that ought to be enough for any New Testament believer. Furthermore, I cannot imagine God allowing Christian men (and some continue to contend their wives) to be at risk for 2,000 years for tragic diseases from which he had protected Israel. Surely, God would have spoken far more clearly about circumcision in the New Testament if such benefits had been his intention. Finally, if one believes in the inspiration of the Scriptures, then the words, “circumcision is nothing,” were inspired by the Holy Spirit and are not just the opinion of the Apostle Paul.

### **Are the Old Testament Law and Ordinances Valid Medical Measures?**

The Scriptural evidence clearly will not support the idea of Old Testament circumcision as a health measure.

Neither the then-practiced style of circumcision nor the periods when God condoned noncompliance suggest any such interpretation. As to the matter of possible medical benefits of modern-day radical circumcision, both Jewish and medical, given the lack of any clear research evidence to support such claims and given this country’s current level of personal hygiene, I would hazard to suggest that infant male circumcision today probably provides about the same medical benefits for 99% of its victims as the hole bored in the ear lobe of the self-indentured Hebrew slave in Old Testament times!

A similar conclusion seems justified for all Old Testament ordinances. Each time I read Dr. McMillen’s book, I’m struck again by how carefully the Old Testament examples seem to have been selected and even redefined. The order to cast out lepers to live alone outside the camp is explained by God: “...that they may not defile their camp, in the midst of which I dwell.” And the Scriptures go on to say, “And the people of Israel did so, and drove them outside the camp...” (Numbers 5:3&4 RSV). That event is defined by Dr. McMillen as “quarantine.” Further, he does not even mention the shunning of women during menses. As a psychologist, I can only imagine the psychological toll that such regular rejection would take on the woman. Clearly, much of the Old Testament law contains an element of sacrifice. Logically, you cannot pick and choose at will. Old Testament law handed down by an all-wise God is either *all* good medicine or it is *all* something else! In looking over just those ordinances we’ve discussed in this chapter, it seems quite justifiable to conclude that God’s intent and purpose was *not* to reveal medical knowledge in the law but to fashion a unique people upon the earth.

I presented the greater part of this material dealing with 20th-century Christianity and infant male circumcision at the Second International Symposium on Circumcision, held in San Francisco, May, 1991 (6). At the conclusion of my presentation, a rabbi stood up to the microphone to note that he had agreed with virtually everything I had said relative to viewing Jewish law as symbolic purity and sacrifice and as covenant-based rather than as medical prescription. He did not, however, agree with some of my other remarks which had touched upon human rights issues relative to infant circumcision. And, I suspect, he was not

too pleased with my suggestion that radical circumcision, as now practiced by Jews, is the result of extrapolation and Pharisaism. Nonetheless, he did express the opinion that, in the absence of New Testament ordinance, the act of Christian parents having their son circumcised might well be viewed as child abuse.

As if this venture into religious matters will not get me into enough trouble in some quarters, the speculations I will raise in the next chapter relative to possible adverse psychological factors associated with routine infant male circumcision are bound to raise hackles in other quarters as well.



# 10

## Psychological Factors Related to Infant Circumcision

*“What’s done to children, they will do to society.”*

**Karl Menninger, M.D.**

founder of the Menninger Foundation

Routine infant male circumcision stands in a class by itself. The other once-popular forms of preventive surgery have all been abandoned by the same medical profession that once introduced and touted them. Even when such other surgical procedures as the routine removal of tonsils, adenoids, mastoids, and the appendix were in vogue, circumcision was unique. It is the only routine surgical procedure ever practiced in this country which significantly alters the physical appearance and visible structure of the human body. Further, it is a physical alteration for which the individual is rarely given any explanation. Having had their son circumcised, most parents in this country never mention it again—especially to their son! The child at some point sees another little boy who is different, or reads something, or hears something, or notices his scar, or by some other of a multitude of means discovers ‘it’ was done to him. The stories which men tell about how they discovered that they had been circumcised and how they, often as a child, figured out why it was done to them would make a book by themselves.

I noted in Chapter 4, while discussing circumcision myths, that we’ve been removing foreskins for nearly a century without ever knowing exactly what it is that we are removing. It must be noted here that we’ve also been just as unsure of, and often indifferent to, the possible psychological and emotional effects of the procedure upon the individual. Wallerstein noted in 1980,

When newborn circumcision began to be routinely practiced, the positive aspects were considered to be of such a magnitude that they completely out-weighed any possible negative aspects. To a large degree this view is still held. There has not been one article in a medical or lay journal specifically devoted to a total overview and analysis of the potentially negative psychological aspects of circumcision. The question is usually scoffed at as nonsense (1).

At this point, I wish I could report that the situation has significantly changed since Wallerstein’s rather pessimistic appraisal of the

**NOTE: The original intent of this chapter was to present a variety of theoretical positions in the hope that such a presentation would spark further research regarding the psychological aspects of circumcision, circumcisers, and the circumcised. Due to this intent, the chapter may seem to the casual reader to be unnecessarily complex. There are still many unanswered questions, and it is hoped that those in the field of psychology will take up this issue more thoroughly.**

### Men’s Voices...

“At 21 I went to a plastic surgeon seeking foreskin reconstruction, which left me without options. Disappointed, and accused by my last partner for fearing intimacy, I entered therapy during this period. We discovered that my problems stem from an organic origin, the result of scars remaining after my circumcision.

In one particular session (it was like a black and white film), I recalled confronting my mother at around age four, ‘Mommy, where is the rest of my pee-pee?’ I later also asked her if I had approached her at an early age about the lack of a foreskin. She recalled being caught off guard. She and my grandmother were astounded; they could not figure out why I asked that particular question. I wondered if I gave her any comparatives (like a little boy’s looked different, as did Grandpa’s and Dad’s). She claimed that I didn’t and wondered why I asked her about it. She also said that I wasn’t satisfied with her explanation at the time (I wasn’t satisfied now either).

I also recall another incident that occurred while we were vacationing in Iowa. We had gone to a park where there was a public pool to swim after a family picnic. My cousins, ranging in age from 9 to 16, and myself (age 6) went to shower and changed back into our clothes after swimming. In the shower, my cousins (all uncut) began pointing at my penis and calling me deformed. I’m not sure I knew what it all meant, but I began to cry. I was very upset when we returned to our parents

*(continued)*

### Men's Voices...

and my cousins were verbally reprimanded. I was consoled by being told that they had never seen a circumcised boy before. I hated that word immediately, and loathed being circumcised. Their penises were so beautiful, rich and full. Mine looked scrawny and pink. I remember praying to have my penis back the way it was."

J.M., Peoria

"This is intended to explain fully the reasons why I had pursued circumcision and why now I am investigating foreskin restoration at this time.

I discovered I was different 'down there' in kindergarten, while in the boy's room. At the time, I didn't understand what made the difference. In grade school, I did not find out why me and my brother were different from the other boys. It bothered me at the time that my parents decided not to sign the consent forms when we were born. I never asked until I informed my mom on the eve of my surgery. She told me she was going to have us circumcised at birth, but my father did not want us to be, and since his word was law, we didn't have it done.

Gym class and going to the bathroom were psychologically traumatic. Growing up in New Jersey, in the 1960s and 1970s, I found I was the only one (aside from my brother) to be intact. Health class reinforced my insecurities. We were told every year that circumcision is what is done, that the foreskin was like the appendix, that nothing good comes from it, and that being intact (they say 'uncircumcised') leaves the penis open to infection, cancer, etc.

Since I had no psychological support to be intact, I looked forward to getting circumcised someday. My trauma came about from incessant taunts after word got around that my 'penis was weird.' (Nice friends.) It did not help that my family came from Germany, and the majority of my peers were of Jewish/Italian descent. My foreskin was my mark of inferiority to them that could be pointed at. They knew that it bothered me, so the taunts centered on that at times. It was too embarrassing to speak to anyone, even my

(continued)

lack of solid research in 1980. But I cannot. The situation is not much better. While there is an increasing number of doctors, psychologists, and health care providers willing to question the validity of the procedure, I am unaware of any ongoing longitudinal studies designed to investigate and evaluate the possible short- and long-term effects of infant circumcision.

Enough new voices have begun to be heard, however, that I am emboldened to at least raise a number of questions which I believe warrant research attention. Also, I intend to speculate to some degree as to the possible causes and effects of infant male circumcision at several levels within our society. I can only hope that others will take up the challenge to do the research which will let us truly evaluate what we've been doing to so many men for so long.

### Infant Male Circumcision as a National Phenomenon

What makes one nation stand alone against the opinion of the rest of the entire world? As the only Western, industrialized nation to continue to routinely circumcise the majority of her infant males on nonreligious grounds, America has certainly shown that she'd "rather fight than switch." Even the overwhelming medical statistics from other nations do not deter us. Why?

We've already looked at some of the more obvious historical justifications for introducing routine male circumcision. Now, I would like to suggest some less obvious, and perhaps unconscious, motives which may operate at a national level.

### Possible Motives for Male Circumcision

America does not circumcise her infants. She circumcises her *male* infants!

**Motives: Attitudes and Beliefs.** Our Judeo-Christian heritage teaches us that the true nature of man is evil, and our naive folklore teaches us that males are more innately evil than females. It's a matter of nature: snips and snails and puppy dog tails *vs.* sugar and spice and everything nice. Furthermore, both men and women in our culture tend to believe that males are *naturally* less governable than females.

As a result, for instance, we tend to let baby boys cry longer than baby girls before we attend to them. After all, little boys are just being angry, mean, and demanding; whereas, little girls cry because they are frightened (2). How ironic, both mom and dad seem to want a little 'chip off the old block' who's a 'real' boy, but, at the same time, they view this little monster-in-the-making with a sense of apprehension.

Furthermore, we teach our children in a thousand different ways that boys and girls, and men and women, are fundamentally different creatures. These lessons start from day one with blue and pink

blankets in the hospital nursery and continue throughout the individual's life. I was recently seated next to a mother and her 14-month-old son on a short flight from San Francisco to Los Angeles. The little boy was enchanted by a new toy that his mother had just bought for him. It was a keyboard-style toy with knobs, buttons, dials, and levers designed to teach the child to manipulate each of these devices. When the particular device is properly operated by the child, a cartoon character pops up in Jack-in-the-box style. There are five characters: Mickey Mouse, Donald Duck, Pluto, Goofy, and Minnie Mouse. The five devices consist of four mechanical gadgets to be mastered and one heart-shaped button to be pushed. I don't need to tell you which character pops up when the heart is pushed. I think that little boy will get the message too! And that same message will be given to him in dozens of ways every day of his life. Do you doubt for a moment that that sweet little boy will grow up finding it hard to express his more tender feelings and to accept his own gentleness? Perhaps his wife, like thousands of other wives, will one day complain to a psychologist, or minister, or priest, or rabbi that she just can't get him to open up and share his feelings or pain? Snips and snails and puppy dog tails, that's what we *think* little boys are made of.

And, of course, we haven't mentioned sexual behavior yet. Everyone knows how men are! And, every little boy will, after all, one day be one of them! Not only that, you'll have to really watch him if you don't want him to play with himself! Boys are so nasty!

**Circumcision as a Means of Gaining Control.** Given all this innate evil, anger, and nastiness in males, we've got to find some means of control. We've got to set some limits. There seems every reason to wonder if one of America's major unconscious motives for circumcising her males is an attempt to reduce their 'natural bent toward naughtiness' and show them from the very start who's boss.

A psychiatrist colleague of mine, after a brief conversation about infant circumcision in this country, noted, "What a hell of a first 'message' to give to a newborn: 'around here, young man, you do things our way!'" Strapped spread-eagle to a board, immobilized and without anesthetic, I'm sure he gets *some* message!

### **Possible Effects on our National Character**

Those with less psychological bent will no doubt think it far fetched that I would suggest that a 100 years of infant male circumcision may well play into our national character. But we do know that abused children very frequently grow up to be abusive (3) and even child abusers themselves. Every colleague I know who works with abused children voices a concern over this possible residual affect upon the abused child. Professionals working in this field often speak of the need to 'break the abuse cycle.' I'm astonished, therefore, as a

### **Men's Voices...**

parents. During physical exams my senior year, the school doctor told me I should do 'something about that.' I asked, 'Like what?' He said that I should have been cut when I was born, and asked if I had problems, if not now, then in the future. I tried 'passing' by pulling back to expose the glans to try to experience what it was like to be circumcised. (My intent eventually was to actually have it done.)

My relationships with women in Art College weren't as traumatic, but none of the women had actually seen an intact penis aside from classical nudes. Most accepted me as I was, though a few let it slip that I'd be healthier without a foreskin. Since I had ready access to Barnes & Noble, I pursued all the information I could find about circumcision. However, I did enjoy a number of healthy, wonderful sexual experiences and a few great relationships.

I thought about remaining intact many times, but no supporting information from the medical establishment was found. All the books say that the foreskin is treatable by simply circumcising the patient. When I started to have phimosis at 25, I went to see a urologist about it. He wanted to simply cut it off and that's that. I went to a second urologist who told me I could have a dorsal slit, but that the circumcision would be better. (No one told me I could keep my foreskin, without surgery, just by stretching slightly and keeping it soft with vaseline or hand softener!)

I asked my urologist to tell me how often he does this. He said I would be the third that day. My appointment was October 16, 1987. The doctor did a freehand cut after injecting me with a local anesthetic. I was expecting a nice, even cut line, but the line was jagged with the right side having about 1/8" more slack. I was appalled enough to tell him on my follow-up visit. He told me he could 'even it up.' I left it as it was.

Three years later, I saw an article in the local newspaper's health section about the controversy over neonatal circumcision; I wrote for some information.

(continued)

## Men's Voices...

After my circumcision, I started dating a girl who told me about foreskin restoration. She had heard of the surgical process from someone at her office who had seen it discussed on public television. I became interested in the techniques and the possibility that I might regain some level of sexual pleasure I had before. (I wish I'd thought about remaining intact as much as I had pursued circumcision!)

I know it won't be 100%, but I think that if the medical and health establishments had given me some support to remain intact, I wouldn't have looked forward to circumcision and probably never would have had it done. That was my choice then to do it.

It is now my choice to recover. I hope my current partner will understand when I start restoration. I think I can change her mind about circumcision when we have a son. Her friends (and her siblings) have already made their sons' choice for them. I hope other men didn't go through what I did as a child, but undoubtedly some have.

As far as my sexual experience with post-circumcision versus pre-circumcision, I can say the effect is like a slight deadening (like a callous on your finger), since the glans head has roughened and the mucous membrane of my foreskin has been removed."

L.J., Baltimore

"I am 62 years old and can say decisively that the single most traumatic event of my life, the event with the greatest pervasive psychological damage was my circumcision as an infant. In the course of my adult life, I have attempted to address this with five different therapists without significant help from any of them. My first attempt was disastrous; some warned me against trying, others agreed to try to help but could not.

I finally wrote in my journals that if I cannot address the issue in therapy, then I must in some way deal with the ramifications of not addressing it. By this time, I was in my mid-forties and thinking of suicide. I have had to work things through on my own, a task which has met with

*(continued)*

psychologist, when these same individuals are often totally indifferent to the possible effects of painful genital surgery upon the infant male.

We are a nation with a high rate of violent crime: battery, rape, murder, etc. The rate of young male suicides is also alarmingly high—near epidemic. Do males, violently traumatized as infants, grow up to be more prone to abuse others and themselves than their counterparts in noncircumcising nations? We need the answer to this question. We need well controlled, valid research. If early exposure to violence does indeed predispose our young men to violence, routine circumcision is costing us far too much as a nation!

**Denial.** This defense mechanism allows human beings to distort their perception of a condition or event. We, as a nation, have a long history of denial. The examples are legion: slavery with our once-held defense that, after all, most 'darkies' really want to be 'looked after,' or segregation with our insistence that minorities would really rather be with their own kind, or rape with our historic stance that most victims were either where they didn't belong or were 'asking for it.' By such perceptions we have historically been able to distort and deny reality to the point of justifying injustice.

In October, 1991, LIFE magazine devoted an entire issue to a feature entitled: "The Journey of Our Lives." The caption read, "... Pictures Celebrating the Most Important Moments in Every Life" (4). The first group of pictures were, of course, depicting events during infancy and early childhood. The first picture shows a naked infant screaming in fear as he is lifted out of the water after being totally immersed in a baptismal font. Another picture shows a four-day-old child swaddled from neck to feet unable to move any portion of its body. We are told that the child will be wrapped like this for 40 days to protect it from evil! The next picture shows a crying baby boy having his foreskin cut off in a religious ceremony, while the next shows five infants on a mattress being jumped over by a man who has taken a running leap in order to clear the mattress on which they are lying. Another picture shows a mother and an "initiation guide" passing a naked young boy, eight or nine years of age, three times through a split sapling.

In one of the two pictures which follow, a young Egyptian girl is having her clitoris ritually cut off while her mother holds her—be sure to look at the girl's eyes. And, in the other, a young Turkish boy has been circumcised and dressed like a "king," but you can easily see the blood on his hand where he has been holding his wound. Be sure to look at his eyes too! All of these moments are called "Celebrations" in the article. It is plain to see that the infants and children in each of these pictures are *not* celebrating.

What allows us, as a nation, to look at these pictures and pass them off as ‘interesting customs’? If we saw them for what they truly are, we would be in the streets tomorrow marching for the rights of children to the integrity of their own body! But we as a nation do not see these customs for what they are. We have our own infant mutilation to live with and, therefore, to justify. I submit to you that our need to deny the pain and the effects and to justify the continuation of routine infant male circumcision in America distorts our perception of those things done to children worldwide. After all, these rituals make the adults feel more secure, and the pain and terror of the children only last a little while!

**Humor.** It is debated among psychologists whether humor is itself a defense mechanism or simply a facet of denial. Either way, it helps us distort and redefine human behavior, often in the extreme. The following tragic axiom is only too true: “Whatever they can laugh at, they can continue to do.”

James Baldwin, in his book, *GOING TO MEET THE MAN*, paints vivid images of a white family going to a “picnic” (5). As they are driving in their car, the father tells his young son, “You won’t ever forget *this* picnic.” The occasion for the picnic is actually the lynching of a black man accused of knocking down a white woman. The young boy, who is telling the story, relates: “They were singing in the cars in front and behind”; A man brandished a knife at the dangling man, “and a wave of laughter swept the crowd”; and, “I reckon we better get over there and get some of that food before it’s all gone.” These and other details set the scene. Most of us, through the years, have heard the lynching jokes; we older ones have heard the Jew jokes told by Hitler’s S.S. men; and some of us have heard the racial ‘comic’ songs like “Preacher and the Bear” on old cylinder records. The fact remains, if you can laugh about it, you can continue to do it. It isn’t until the truth somehow penetrates the consciousness that prejudice and brutality quit being funny and become repulsive.

While I was preparing this manuscript, I chanced to catch the routine of a stand-up comic on late-night TV. The comic is Jewish, and he had just had his twin sons circumcised in a ‘double-header’ bris. His entire 8-10 minute routine was a very clever recounting of the double circumcision ceremony. He was able to relate that the babies were crying, the old ladies were chattering, and the men were guarding their crotches, all to the delight of the audience. When I heard the boisterous laughter of the audience, my hope that this work would be taken seriously went through some very dark moments. If we as a nation can laugh that hard about an infant’s pain and terror, we can keep right on doing what we’ve always done and get a good chuckle in the bargain!

### Men’s Voices...

little success. This means that I still carry with me the psychological scars and the sequelae of secret thoughts and aberrant behavior patterns. This means I have lived my entire adult life in two worlds: that of a successful teacher and later a social service worker, but always slipping in and out of the demi-monde of extraordinary sexual activity with the concomitant of guilt and stress. How very different my life might have been if there had been some way of getting early on a simple affirmation of the psychological damage that I had sustained. Now, with a lifetime of service behind me, I am able to say that I have succeeded in working out a rich life despite the terrible burden I have carried all these years. I very much would like to be of assistance in easing the burden of others who could benefit from my experience.”

Retired teacher, Sacramento

“I am 40 years old and was circumcised at birth against my will. I am very concerned, angry, and resentful about this. I have gathered a tremendous amount of literature on the subject of circumcision. I have been studying the pros and cons for about 15 years. I do everything I can to help stop people from doing this to their sons. I can almost accept what happened to me as a child, but what I can’t stand is the fact that on any given day about 3,000 boys have their penises cut with no anesthesia, and the most sensitive part of the penis is thrown away. And no one thinks twice about it.

Most doctors are all for the needless operation. My urologist said, ‘They only do it for the money.’ This must be stopped somehow. What can I do, and what can all of us do who are against nonmedical circumcision?

I am currently undergoing the non-surgical foreskin restoration techniques. I started in October. I am pleased so far with the results. My skin seems to be growing already. I was very tightly cut so I have a long way to go. I just want enough skin to cover my glans. One question: since I am so tightly cut, I have to pull the tape tight, and I have a lot of trouble with the tape on.

(continued)

## Men's Voices...

Are there any tips you can give me about this problem?"

P.C., Kansas

"For close to three years now my penis is a different one from what it was. Erections are weak. The penis, especially the head, has shrivelled. The head is constantly cold and sometimes numb. The tone is overall weak. Sensation has lessened considerably.

I am a 36-year-old married man with an active monogamous sexual life. This change has affected me terribly, almost to the point of impotence. I have had a very early and active sexual life.

I had a penile blood flow study done and everything was normal. I have been to many physicians and 'healers' all to no avail.

The circumcision aspect rings true, especially considering that I have no surrounding skin left at all. There are no folds of skin under the head. It is tight and bare.

Please send me some information on how to start rebuilding my foreskin. Also, how do I know that this really is the problem? I'd be grateful for every and any bit of help, information, referrals, etc. that you can offer me."

R.J., Texas

"As a little boy I was aware that I did not look the same as my dad or brother. However, as I remember, I put that down to the fact that I was little and they were grown. Some place in there I became aware that I did not look the same as other boys my age. As a result, I hid myself from other boys. I would not play a game that required the removal of clothing. I must have been five or six when during a visit to the doctor, he asked me to retract the foreskin which moved back freely. Wow! Now I looked like the other boys and my dad and brothers. I had heard the word 'circumcision,' but did not understand that it was a surgical procedure. So, in my young mind all I had to do was pull the skin back and I was circumcised. I would pull it back, but the skin would slide forward. I must point out that at this

(continued)

## Infant Male Circumcision and the Medical Community

If America stands alone as a nation among nations in terms of infant male circumcision, the American medical profession stands alone among all other medical communities. The American medical community is arguably one of the finest, most advanced medical bodies in the world. Why, then, this commitment to infant male circumcision? What causes them to ignore the evidence from every other like organization in the civilized world?

### What Motivates the Circumciser?

Many doctors note with pride the fact that they speak with authority on the subject of infant circumcision, having performed hundreds or even thousands of them. Others note that they continue to perform circumcisions at the request of the parents even though they, themselves, see no medical advantage to the procedure. What allows these individuals to walk up to a crying baby strapped to a board and take up probes, clamps, and scalpels and amputate a healthy part of his body?

**Training.** Physicians are often called upon to perform unpleasant and painful procedures for the good of their patients. Detachment and noninvolvement are necessary defenses against emotions which could easily interfere with the task at hand. The need to keep a level head and a steady hand dictates that the physician steel him- or herself against the pain of the patient. And most of us are grateful for just such a trained specialist when we or our loved ones require medical treatment.

**Beliefs.** Most of us use a variety of beliefs to justify our actions. Doctors are no exception. One can hear the reassurance intended in Dr. Silber's words:

For the newborn infant the operation is fairly simple. Although it must be very painful, the child is traditionally not given an anesthetic because the risk of doing so would be too great. Furthermore, *most medical authorities feel that the brief pain caused by the operation has no harmful effect on the child* (6). (Emphasis JB)

When one is asking tough questions about motives and defenses, the question must be raised: Who is Dr. Silber reassuring, the reader or himself?

Further, the belief that 'the end justifies the means' is also a powerful defense mechanism. If a doctor is convinced that circumcision is *good* for the male, then a whole series of 'logical' conclusions suggests that during infancy, at a few days of age, is the best time to do the procedure—for the boy's good!

**Power Needs.** If we were discussing business tycoons who climb the corporate ladder, the suggestion that the need to feel powerful might play a part in their choices and behavior would not shock anyone. But to suggest that a doctor would be motivated by anything less than a pure desire to serve humanity is to some tantamount to blasphemy.

From a purely sociological frame of reference, however, various professions in any society can be ranked as to the status and power which each provides to its practitioners. When this is done, doctors are never far from number one, certainly not in America. It does not seem too unkind, then, to suggest that individuals choosing a career would recognize the social and economic benefits which accrue to those who become doctors. Whether we look at the scene of a doctor performing surgery on an anesthetized individual or simply writing out a prescription, the scene is one of individual power. And, if the scene is a tiny infant strapped down and immobilized with his tiny penis protruding through a hole in the draping, the power is almost that of omnipotence!

Before leaving the idea that medical practitioners may be motivated by power needs, it is interesting to note a current debate within one segment of the medical community. Currently, the Kaiser-Permanente Medical Group is considering whether or not to continue to permit Certified Nurse-Midwives (CNMs) to perform routine circumcisions in their facilities. One notable spokesperson defending the practice is Certified Nurse-Midwife/Certified Mohelet Ilene Gelbaum. She was active in the original fight in the early 80s for the "privilege" of CNMs to perform routine infant circumcision at Kaiser facilities. In May, 1990, Gelbaum made a presentation at the annual meeting of the American College of Nurse-Midwives (ACNM) in Atlanta. Her presentation was entitled: "Male Newborn Circumcision: The Nurse-Midwifery Model" (7). And, in 1993, Gelbaum published a 13-page article meticulously describing the "Gomco clamp technique" in which "Step-by-step detailing of this surgical skill and implications for practitioners are explored" (8). Gelbaum is both among the first CNMs to perform routine circumcisions at Kaiser Medical Centers and, as a woman, among a very small number of Certified Mohelets within the Jewish community worldwide.

I listened to an audio cassette of her ACNM presentation with great interest. Not only does she describe the circumcision procedure using the Gomco Clamp in careful detail, she relates how she sought and achieved not one but *two* certifications to assure herself access to the "privilege" of circumcising infant males! As a CNM, Gelbaum describes having to prove herself so that "privileges [to do circumcisions] would be granted." As a mohelet, she says, "It is really a touching, moving, spine-tingling thing that I participate in as a service to the community." As I listened to her presentation, I could not help

## Men's Voices...

point in time I had a long overhang. I kept pulling the skin back, and after a period of time, I no longer remember how long, the foreskin remained back and never came forward except when masturbating.

Some seven or eight years ago I commenced to notice more and more young men, and older men, with foreskin. I would see these guys at the health club and ever so many of them at the nude beaches in Holland and in hotel saunas in Europe. It struck me how much better they looked and how much more natural they were.

I commenced to push the skin forward, but it would not remain forward. I kept at it and now it remains forward almost 100% of the time—it even moves forward after an erection. It does retract fully during an erection. The skin on the underside is longer than on top. It is my hope that with the procedure you outline I will be able to retain coverage during erection, and when flaccid I will have a healthy overhang.

I have no understanding what it would be like to masturbate in the circumcised condition, but I do know that with foreskin it certainly is most pleasurable.

I thank you for the info you have sent me. Of course I do have more to start with than a circumcised guy, but I often wonder how much foreskin I would have today had I not kept it pulled back for more than 50 years.

Until I received your information I had not been stretching; I had only been pulling the skin forward and seeing to it that it remained forward. Now I am stretching according to your advice."

S.D., Detroit

"I have never been raped in any traditional sense, but I have been grossly violated and permanently mutilated against my will by someone I should have been able to trust who had the permission of others who should have been protective of me. Who violated me to the point that I feel raped? Who left me permanently mutilated in such a way that I am reminded of it every time I make love, or urinate, or even get dressed. You did when you circumcised me after convincing my parents that

(continued)

### Men's Voices...

the procedure was good, even necessary, in spite of the fact that 80% of the world's male population is not circumcised. Even my own father was not circumcised at birth and has certainly never found it necessary to seek circumcision during his adulthood.

I fully realize that I was born in the wrong place at the wrong time to have avoided being routinely mutilated, since nearly 85% of American males' foreskins were being amputated by scholastic physicians during the 1950s. I also fully realize that the circumcision rate in this country continued to rise to nearly 90% by the early 1970s, and that the tide has only begun to turn toward sensibility in the last decade. Nonetheless, 10% to 15% of the American males born in the 1950s were left with their sexual organs intact by informed parents and/or doctors who realized that playing God and attempting to redesign the male anatomy was not only absurd, but potentially emotionally damaging to the victims as well (not to mention the physical damage).

I have always believed that the main purpose of a physician is to help patients become and remain as healthy and whole as possible and that surgical procedures are only used acceptably to remove diseased (not healthy) tissue. Therefore, I can accept my appendix scar because my appendix was diseased, and my appendectomy was necessary to save my life, but I cannot accept my circumcision scar because that procedure, as routinely performed on infants, is no more than a ritual scarification as objectionable as tribal scarification rites in primitive Africa. It has absolutely no medical value, except in extreme cases on adult phimosis (and even then, in Europe, doctors tend to try to save the foreskin and treat the infection medically). I cannot even look at myself in the nude without becoming enraged at you and the system of which you are a part for leaving the most sensitive and private part of my body visually disfigured and functionally altered. Because of you, I will never be able to know how sex is really supposed to feel. You destroyed the erogenous nerves that were present

*(continued)*

but ponder just what Fraud would have to say about the motivation for and the 'spine-tingling' devotion to such a task?

As a psychologist, I would not speculate as to the motives of any particular individual. On the other hand, I cannot help but wonder what would motivate these women who have traditionally championed the cause of more natural, less mechanized birthing procedures and environments to even consider taking up the scalpel to do such an unnatural thing to an infant they have just helped into this world?

### What Happens to the Circumciser?

It is an unavoidable truth that an individual's behavior shapes that individual in an ongoing process. It is also true that psychological defenses which at first allow an individual to function under a stressful condition can become incorporated into the very fabric of the individual's personality. What is the ongoing effect of those defenses which initially shielded the doctor against undue empathy and vicarious pain? What patterns of thinking become fixed so that the individual is not disturbed by what he or she does? In short, what happens to the circumciser who repeatedly performs the procedure on an unanesthetized and traumatized infant and must defend against emotional involvement in order to carry out the task?

### Exploring the Defenses

Most of us would accept the medical profession's explanation that it is necessary for a doctor to remain somewhat aloof and detached in order to perform many of the tasks required by the profession. But what are the long-term effects upon the doctor who regularly and repeatedly relies upon psychological defense mechanisms in order to survive in his or her profession? And what are some of the more probable defenses used relative to infant circumcision?

**Denial.** As noted above, this defense mechanism allows an individual to distort his or her own perception of an event. Clearly, the medical profession's long-held belief that the newborn does not feel pain is a case in point. Even when the infant screamed and vomited, this defense allowed the doctor to perceive an angry little boy getting all worked up because he was being pinned down—the feisty little devil! Note again Dr. Taguchi's statement: "Every baby cries lustily throughout the ordeal, but I am not certain whether the infant is objecting to being strapped down or to the clamp" (9).

CNM Gelbaum notes in her presentation cited above that parents need to be prepared for what they will see the first time they look at their son's circumcised penis. She says, "I cannot begin to tell you how many parents undo the diaper, look at all that red stuff, and assume all of that is the circumcision." She then goes on to note the need to inform the parents as to the "normal" appearance of a



circumcised penis. Somehow, for Gelbaum, disassociating the stripped, raw glans and the traumatized mucous tissue from “the circumcision” is important. It is difficult to imagine that anyone could look at a newly circumcised infant penis and deny that “all that red stuff” was caused by the circumcision procedure. Surely it is easily perceived that the trauma to the infant penis is far more than the actual cut around the organ. Denial is indeed a powerful defense mechanism!

Dr. Samuel A. Kunin, a Southern California urologist, is widely known as a pro-circumcision activist. He recently replied to a published interview in which R. Wayne Griffiths explained that he had sought foreskin restoration because “his skin was often chafed, underwear was uncomfortable, and sex, ...there was not much feeling” (10). In an effort to debunk Griffiths’ statement, Dr. Kunin retorted: “Do you really think that 70% [his estimate of the circumcised male population] of American males are walking around chafed, uncomfortable and sexually diminished? If that were true, there would be no need for anti-circumcision groups” (11). Ironically, if Dr. Kunin were to learn that the vast majority of genitally mutilated females speak quite positively about what was done to them and express gratitude to their parents for what “they did for me” (12), he might well be puzzled but would, no doubt, understand the incredible power of denial to control human perception of both ourselves and our personal world. So great is its power, in fact, that Dr. Kunin himself *denies* the possibility that most circumcised American males are shielded by denial relative to their diminished penis.

**Humor.** The AMERICAN MEDICAL NEWS carries a regular feature entitled: *A Chuckle a Day Keeps the Doctor Happy*. In April, 1991, under the heading, “Airborne Babies,” it carried the following anecdote submitted by a West Virginia doctor:

After male babies were delivered, the circumcisions were done on a table in a room just off the nursery. If the curtains were open it was possible to look through the glass enclosure of the nursery into the anteroom.

As I was doing a circumcision, I glanced up to see the mother peering intently at me. The nurse discreetly pulled the curtain.

Later, in the hallway, the mother assured me she was simply interested in the procedure. “What do you folks do, anyway?” she asked. “Let the air out of it?” (13).

The ‘joke’ was made by the mother, the chuckles were provided by the doctors. FAMILY MEDICINE (1994) published a letter from a Fresno, California, doctor which gave detailed instructions for constructing an inexpensive “teaching model” for training medical students to perform circumcisions. The instructor noted: “The only drawback was enduring some of the off-color remarks made by the residents in attendance” (14). Whatever you can laugh about, you can go on doing!

## Men’s Voices...

in my foreskin, so that even if I go to the time and expense of having my foreskin reconstructed to make my penis look and function as normally as surgically possible, it will never feel like it was supposed to feel.”

An open letter to the doctor  
who circumcised me

“The other night on a radio talk show when a woman called in and said her vagina hurt after intercourse with her husband, she was advised to see a doctor.

Why was it assumed something was wrong with *her*?

Isn’t it possible—even likely—that the pain she feels is the result of friction caused by the absence of a sensitive, self-lubricating, movable sheath of skin—a foreskin—from the penis of her circumcised husband?

Could there be a connection between the continually recurring theme on men’s “detective” magazine covers—the bound and gagged woman shrinking from a man with a knife—and the fact that most men in this country had a similar experience when they were babies, when someone restrained them, ignored their screams, and cut part of their penis off?

Has anyone investigated the possibility of a connection between all the unnecessary amputations and other unnecessary surgery performed on women in the U.S. (cesareans, episiotomies, hysterectomies, mastectomies, etc.) and the fact that most of the doctors who perform those operations are themselves the victims of an unnecessary amputation: circumcision—requested, consented to, or allowed by their mothers?

If a circumciser circumcises an adult with the adult’s consent, that’s one thing—at least an adult has a choice and a chance. But to circumcise a baby, knowing that the only reason he can circumcise the baby is that the person he’s circumcising is a baby—that, surely, is the ultimate perversion, child sexual abuse in its most vicious, most degenerate form.

(continued)

## Men's Voices...

Yes, of course, anyone who commits such an act is sick and needs help. But doesn't he first need to be stopped?"

John A. Erickson, Mississippi

"My parents never used the word 'penis' because it wasn't in the Bible. They used the word 'foreskin' instead. This caused me endless confusion.

When I was about seven I asked my mother why my 'foreskin' always stuck out but my older brother's didn't (since the head of his penis was covered with skin but mine was always exposed). 'Oh, don't you remember?' she said. 'The doctor sewed your foreskin so it would stay back.'

To my young mind, something that was only sewed could become unsewed. I would ask her, 'When is the doctor going to unsew my foreskin?' But she always turned my questions off, never telling me the truth.

When I was nine, a house was being built near ours. One afternoon, when the men had quit for the day, the man who ran the steam shovel asked me if I'd like to see how it worked. Naturally, I was thrilled. I climbed on and he showed me all about it. He was about 40, a smooth talker, and somehow quickly got onto the subject of 'skin.'

He asked, 'Can you slip your skin all the way back? Does it ever pull tight or hurt?'

I didn't know how to answer him because, unlike my father and brother, I had no skin to slip back; but I managed to say, 'The doctor sewed my foreskin so it stays back all the time.'

He said, 'I've never seen a foreskin that was sewn back.'

Anxious to understand what had been done to me, I said, 'I'll show you my foreskin if you'll show me yours.' (He had no way to know that I really meant 'penis'.)

'Sure,' he said, 'I'll show you my foreskin. Let's see yours first.'

I opened my pants and took my little rough-cut penis out. I was watching his eyes and saw his astonishment as he said, 'I've never seen a boy's foreskin sewn back like that.' Then he took out his

(continued)

**Rationalization.** One does not have to be well read or have any special training in psychology to realize how important it becomes for some doctors to continue to believe that infant male circumcision accomplishes a 'good thing' for the baby and even for the community as contended by the midwife cited above. After having performed hundreds, or thousands, of infant circumcisions, how does the individual cope with the possibility that he or she may have been mutilating rather than protecting the little fellow? Typically, one copes by reinforcing the rationalization. After all, 'there are still those who believe that infant circumcision is a good thing'; and besides, 'the little boy will match his father'; and 'he won't need to wash so carefully'; and...!

**Inoculation Effect.** In less sophisticated days this defense was known as 'searing the conscience.' It is the constant build-up of indifference which comes from repeated exposure to a thing until that thing no longer has much, if any, emotional impact at all. Soldiers in war experience this build-up such that scenes which repulsed and sickened them at first become ordinary and common. Thus, the soldier can go on doing what he's been ordered to do. I'm sure the doctor who has performed hundreds of infant circumcisions no longer even notices that the child is screaming in pain and is terrified. 'No more pain than an injection' was Dr. Schlosberg's perception (15).

**Emotional Insulation.** A concept related to emotional insulation is that of stoicism. 'Cocooning' is yet another. This defense provides enough layers of protection that most painful, and in some cases even joyful, events simply do not penetrate the armor. Such a defended individual is protected from feeling. I am in possession of a video tape showing an infant male circumcision being performed. The doctor speaks up over the baby's cries to methodically explain each step of the procedure he is performing as though the medium he is working in were Play-Doh rather than human flesh. I am sure that *nothing* the child did during the entire procedure registered. Not only was the child immobilized by restraints, he and his cries simply did not exist. It appears as though nothing short of respiratory or cardiac arrest under the doctor's hands could have gotten that doctor's attention to shift from the clamp he was installing to the baby himself, although the doctor's attention on occasion does shift in order to provide a careful commentary for the video.

The questions which must be asked from a psychological point of view are: What happens to the person as these defenses become integral parts of the personality? How many other areas of life do these defense strategies eventually affect? How much of life itself is filtered out by the very mechanisms which allow the doctor to continue to regularly inflict such pain upon infant males in this country? This

question is especially puzzling since the doctor knows, in another carefully separated part of his or her mind, that such a baby would be at that very moment cuddled in his mother's arms or discovering his new surroundings in any other country in the Western world. By the way, the defense mechanism which keeps two or more conflicting ideas carefully separated is called 'logic-tight compartments.'

### Cognitive Dissonance Theory

This psychological theory deals with styles of *thinking* rather than feelings or emotions as such. The simplest axiom of this theory is that the individual will seek to maintain a harmony between or among the various aspects of an issue at the cognitive level. In the 60s, this theory was very popular and generated a great deal of research and attention (16).

I'm often reminded of this theory as I read letters from circumcised men which relate such scenes as a doctor getting *angry* when a man complains to him about being circumcised. Why anger? Is it perhaps true that the doctor simply cannot allow himself to be sympathetic to a male who says that he has been *harmed* by an act which the doctor's own profession has performed for the man's *good*? These two ideas may well create dissonance rather than harmony when they come together in the doctor's mind and in his office. Such dissonance may well cause him to lash out in anger.

I do know that men do not typically have such experiences when they complain to a doctor about other physical injuries. I also know that women who have had to have disfiguring surgery, such as breast removal, do not meet with such indifference or anger when they seek restorative help. What, indeed, causes a male doctor to tell a male patient that he is 'sick' and needs psychiatric help because he wants the doctor to help him restore a missing part of his body? I am familiar with cases in which the doctor has actually stood up and asked a male patient to leave his office. What kind of realignment would need to go on within such a doctor's thinking to allow him to extend his hand and his heart and offer to help undo what another doctor has done? Or, perhaps it is the idea that a *male* is making a fuss about the appearance of his body in a way that only a *female* is expected to fuss about the look of her body that causes dissonance for the doctor? When a colleague of mine finally got up the nerve to tell his doctor that he resented having been circumcised as an infant, *she* reached out, pinched his cheek, and replied, "Ah, poor baby, did you get *snipped*?" (17). I do not have the answers, but I certainly have the questions!

### Parents and Infant Circumcision

When parents are asked why they had, or will have, their son circumcised, the answer is usually one of the common ideas: it's

### Men's Voices...

penis, the head completely covered with skin. 'See my foreskin?' he asked.

I could see it alright!

He slipped the skin back slowly until the head was exposed, and said, 'I can make mine look like yours too. See yours? See the scar all around it?'

Yes, I could see it clearly. 'That's where I was sewed,' I said.

'Son,' he said gently, 'you are circumcised.'

'Oh no, I'm not,' I said bravely. 'I'm a Christian. I'm not a Jew.' (I had heard in Sunday school that Jewish boys were circumcised and Christian boys were baptized.)

'See the little marks going all around?' he asked.

'Yes,' I said.

'That's where you were sewed. Look here.' He pulled gently on the skin of the shaft but it was too tight to move. 'See?' he said. 'There's no loose skin like mine.' Then he slipped his foreskin back and forth over the head of his penis and I could see exactly what had been done to me. I could see that *that* part of me had been cut off!

I panicked.

'When will my foreskin grow back?' I asked.

'Son,' he said softly, 'it will never grow back. You are circumcised, and you will always be circumcised. Nothing can ever change that. You have no foreskin.'

I was too stunned to speak. I burst into tears. I didn't want him to see me cry. I climbed down and ran until I was out of sight. I was so enraged I couldn't talk. The people I had trusted had told me all those lies about being 'sewed,' and I realized I would be cut like that—an amputee—for the rest of my life.

I went back the next day, but the steamer was gone, and I never saw the man again.

I never told my mother I knew she had lied to me. I couldn't make myself talk about it. Several times I worked up the courage, but when I opened my mouth to speak, the words stuck in my throat and no sound came out.

(continued)

## Men's Voices...

That was over 60 years ago, but I remember it as clearly as if it happened yesterday—and the words, ‘You have no foreskin, ’still resound in my head.”

A disturbing account compiled from correspondence received by John A. Erickson, Mississippi

“It was done to me because it was done to my father—and when our son was born, I said no to circumcision. But the 60-year-old doctor got my wife to sign, so they cut him. I believe this an old, horrible procedure that is quite useless and stupid. My older brother went into the Korean War and the doctor said it was ‘regulation,’ and did it to a 17-year-old boy. I remember he was horribly embarrassed, humiliated and given no choice. They just cut.”

M.Q., Ohio

“I was circumcised as an infant and have always resented it since I was old enough to realize what had been done to me, especially without my consent. Our son, who is by my wife’s previous marriage, was also circumcised, because the pediatrician had told my wife that he was circumcised when he was 30 because he had a problem, so to avoid this, our son should be circumcised to avoid any problem later in life.”

W.T., Indiana

“I was circumcised at the age of 9 to 10 years and remember both the time of the surgery and my foreskin before it was taken from me. There was no physical-medical reason for this form of child abuse that I suffered. I had my tonsils removed in hopes that it would aid in my severe earaches; and my prepuce removed because ‘it wasn’t done at birth.’ I can recall the extreme sensitivity of the newly exposed glans and the ugly tags and remnants of my former perfect penis. The operation left many scars on my penis and on my brain. I have had a hard time allowing anyone to touch or see my penis ever since, and I am over 40 now. I feel that the late age of my abuse has done damage to my life that nothing will ever cure.”

Emergency Medical Technician, Oregon

cleaner, it’s less trouble, so he’ll match his dad, so he won’t be different from other boys, etc. But my training as a psychologist would certainly be wasted if I settled for these rather glib responses without probing to ask about the real reasons. Why *really* do parents have it done?

## Preliminary Research

At the Second International Symposium on Circumcision (1991), Elizabeth Noble presented the results of a preliminary study she had conducted to explore what factors had influenced or empowered some parents to refuse to have their son circumcised in spite of spousal, familial, religious, cultural, etc., pressures to do so. The subject population she focused on were specifically those parents who had experienced pressure from some quarter to have the circumcision done but had the courage to ‘Just Say No!’ (18).

In introducing her presentation, Noble noted one particularly interesting observation—interesting to a psychologist. She said that one of the factors which made her launch the study was the fact that members of her own staff, who had access to most of the available literature on the subject, had taught classes in which the risks and lack of necessity of routine circumcision were discussed, and who were personally opposed to circumcision, would often return from maternity leave to report rather sheepishly that they had caved in under the pressure and had ‘it’ done. Education and conviction were not enough to empower these women to simply say ‘No.’ Armed with this realization, Noble set out to try to identify what factors do indeed empower the ‘nay sayers.’

Her survey of parents who had not had their sons circumcised gathered personal reports to see if there was some common thread that would link these parents. As a psychologist, I found myself hoping she had given these parents various personality and other psychological tests to see what sort of *personality* has the courage to stand up and out and say ‘No!’ Unfortunately, this was indeed a preliminary study, and my questions will have to wait for further research.

## Conformity vs. Nonconformity

Noble’s preliminary study reminded me of a very large body of research in the field of Social Psychology. This research has sought to determine what factors influence an individual to conform to the group norm and what factors help the individual resist (19). The significance of finding answers to this research question fluctuates depending on whether the group in question is a street gang or the culture at large. Whatever the group, its influence toward conformity is a formidable force.

### What Makes Mom and Dad Say Yes to Circumcision?

While Noble sought to discover what enabled some parents to say 'No,' my interest here is to speculate on what causes others to say 'Yes,' even when many of these parents are individually quite dubious as to the value of circumcision and some are actually opposed.

**The Need for Approval and to Conform.** This is the 'they-made-me-do-it' syndrome. Even criminals often use as their defense the fact that they got in with the wrong crowd and could not withstand the influence of the gang. It does seem to be true that the need for and the influence of approval are very powerful forces indeed. The school of Behavior Modification bases many of its therapeutic procedures on the very simple, but powerful, approval need.

It has been discovered, for instance, that a teacher who is trained to 'reinforce' appropriate behaviors in a problem child can bring about incredible behavioral changes by the simple act of regularly rewarding the desired behavior in the classroom with M & Ms or even just smiles! The need to be 'smiled upon' is a very powerful motivator. It is a well-known fact that, when individuals do stand up against the tide and, thus, meet disapproval from some quarter, they very quickly seek out others of like persuasion who will now smile upon them in their new stance. This motive seems to be a very real factor in the success of such groups or support systems as AA, halfway houses, drug rehabilitation programs, etc.

Given these observations, it seems clear that the nonconformist must be absolutely convinced, committed, and empowered in order to refuse to conform. Short of this degree of determination on the part of parents, many little boys will lose their foreskin in this country so that mom and/or dad can have the smiles *they* need.

**Introjection.** This dynamic has to do with how human beings take on the values of their social environment. It is closely related to the concept of the need for approval which we discussed above. Most of us, who have raised a family, have seen this mechanism in action. It happens, for instance, when we say, "No, no Jeffrey don't touch!" And, then, a little later we overhear our toddler scold himself with our very words, "No, no Jeffrey don't touch!" We've got him! The reprimand now comes from *inside* Jeffrey.

Introjection is the major mechanism in such generational phenomena as racial prejudice, political and religious views, etc. Richard Rodgers noted in *SOUTH PACIFIC* that, if you're going to hate all the people your relatives hate, "You've Got to be Carefully Taught." Actually, it's much simpler than that. You only need to be smiled at for behaving, talking, and believing the 'right way,' and you're well on your way to extending the status quo for yet another generation. Why do many parents have their sons circumcised? 'We do it that way

### Men's Voices...

"I was circumcised against my will by a lady doctor who told my mother it would cure my bed wetting when I was just 8 years old. My mother and I have talked about it and she now knows she was tricked into it, but she has no way to bring it back or change it. I feel a part of me is gone forever."

T.B., Edmonton, Canada

"At work I have given literature to fellow employees who were expecting. One woman already has a son who was circumcised. Her comment was, 'I didn't know they hurt my son that way!' She went on to tell me that the doctor discussed the entire delivery process with her for 10 minutes and said nothing about circumcision except asking her yes or no. Personally, I have raised people's awareness, and infants will be spared because of my efforts.

Personally, I'm not doing too well emotionally. The rage, grief and resentment is not much different from what rape victims have. Fortunately, I have a person who is able to counsel me. It is beyond my understanding at this moment how any society could ever practice such a thing on a mass scale. Circumcision is both child abuse and rape. Those who practice it belong behind bars, not behind a mask of medical acceptability!"

L.R., Indiana

"I don't think that I am the only man to ever have his urethra severed just behind the head of his penis by an inexperienced intern performing a circumcision. I did not need circumcision. I was 24 years old. The Master Surgeon said, 'It is a simple operation, and once you are in the hospital, you might as well have it done...I will perform the operation myself.'"

K.E., North Carolina

"I was circumcised on my parent's kitchen table when I was three months old. I was premature. My mother never forgot the experience or forgave the doctor."

L.K., San Jose

## Men's Voices...

"I was circumcised at birth, just because that was the way it was done in 1962. I'm a 26-year-old professional. I have often wondered what sex would be like if I had not been circumcised. It seems to me that it would be better if I had not had the operation. For example, if you worked all day with a glove on one hand and the other bare, you would have more feeling with the gloved hand, right? At any rate, I think it is done today for only two reasons—religion and doctors who want to make a fast buck off some poor uninformed parents. Hopefully, this will become a thing of the past."

S.C., New Mexico

"Please send me any information you have regarding foreskin restoration. Having never had or seen an uncircumcised penis, I would be very interested in knowing what the normal dimensions should be."

P.D., Canada

"How has circumcision affected my life? Well, since I don't remember having a foreskin, you'd think my circumcised penis would seem 'natural' to me. It doesn't. It looks and feels incomplete, deformed, maimed. It's really like I'm searching for the missing part of me."

M.W., Indiana

"Most circumcised penises still have an inch or so of the inner mucosal lining remaining. For me, 75% to 90% of my sensitivity is in this area, with the glans abnormally sensitive to discomfort, and severe pain during orgasm if simulated then. If my circumcision had been as radical as a Jewish one, I would have no sexual pleasure. (How many of us have suffered that fate?)"

M.E., Virginia

"When we (men) discuss circumcision, and the pros on not being cut, no one listens, not even doctors. I am one of millions of men who does not like the fact that I am circumcised. I never have liked it, and wish I had been able as a baby to sit up and scream at the doctor to 'take your hands

*(continued)*

in this great country of ours!' 'We do it that way here.' 'Grandma and grandpa did it; mom and dad did it; and we do it!' Who needs more reasons than that? It has shocked some of us who are working to bring an end to routine infant circumcision in this country to actually encounter the 'America—love her or leave her' sentiment for even suggesting that we as a nation are making a grave mistake by continuing a failed medical experiment.

**Control.** We've already discussed the possibility that America as a nation endorses male circumcision as an unconscious attempt to gain some control over the hard-to-handle-and-control male of the species. If such a motive operates at a national level, it seems reasonable to wonder if it also functions at the family level. When the typical American family has their approximately 2.4 children, one of them is most likely to be a boy. This means that the parents may be dealing with one 'sugar and spice' and one 'snips and snails.' We've already looked at the mixed messages that little boys get throughout their childhood. He must be 'all boy' enough to satisfy even dad's unconscious pride in the little rascal. But, he must be controllable enough not to cause major disruption behaviorally, emotionally, or even financially. In typical households this combination will mean that the 'snips-and-snails' offspring will be in trouble and conflict more frequently than his 'sugar-and-spice' counterpart.

If it is true that circumcision may reduce the need for Junior to scratch an itching penis which may well lead him to play with himself, and if it is true that circumcision may reduce his sexual stimulation, and if it is further true that no one will need to teach or insure penile hygiene in order to make sure that he's clean 'down there,' then what a blessing for Junior's parents! At least some of the 'snips-and-snails' component has been rendered more manageable.

**Cognitive Dissonance.** The tendency to preserve cognitive harmony can be seen especially in situations involving a circumcised father. If that father has somehow justified and come to terms with his own circumcision—sometimes by elaborate rationalizations or, on the other hand, by complete denial to the point of absolutely no conscious feelings or attitudes relative to his circumcised state—it is predictable that the decision will most often be made to make Junior 'match.' We've already discussed the fact that Cognitive Dissonance theory predicts that the individual will seek a 'match' among various cognitive issues.

On the other hand, some circumcised fathers do reject circumcision for their son. And it can be interesting to hear the thought processes by which they arrive at their decision. For some, the decision is couched in very rational terms: 'medical science is unable to substantiate their claims,' etc., etc. In other instances, where the

circumcised father is more openly angry about his own circumcision, he can often harmonize his perception of himself as related to his son along other lines of reasoning. One thing is certain, in this society, the circumcised father who does not elect to have his son circumcised will need to make some sort of cognitive adjustment. One such father recently said to Marilyn Milos of NOCIRC, "I look forward to the day when my intact son asks why our penises are different. I'm going to tell him he has the new, improved model!" (20).

**Sexual Repression.** It is tragic that in this country so many negative attitudes about human sexuality abound. As a psychologist, I can assure you that a great deal of the marital counseling I have done has needed at some point to focus on helping the individuals involved develop more healthy and accepting attitudes about human sexuality. It is also true that much of the disdain for sexuality focuses on the sex organs themselves. They are considered dirty, ugly, and evil by more people in our society than most laymen would ever imagine. It is not too uncommon to hear a woman say that she loves being a mother but she wishes that 'you didn't have to do *that* to have a baby!' If anyone doubts the extent of such negative attitudes in our society, one only needs to read any one of the many current books on treating sexual dysfunctions.

Even at a much less dramatic level, our humor on the one hand and our preaching on the other depict sex as naughty and the sex organs as dirty and distasteful. Many of us who are somewhat older only needed as a child to touch our genitals through our clothing to get a 'good slap.' Most of us have learned to endure incredibly uncomfortable degrees of itching 'down there' rather than scratch in public. Just tell most people schooled in these attitudes and beliefs that the circumcised penis is cleaner and you've made a sale! As I have talked to expectant parents about leaving the child intact should they have a boy, I can't tell you how many women have made a wry face and made remarks such as, "Ugh!, I wouldn't want to have to touch anything like that!"

I am convinced that, in order to put routine infant circumcision behind us, as a nation we will need to learn other, healthier attitudes about our bodies, our sexual nature, and our sexual behaviors. As both a Christian minister and a psychologist, I have always regretted that Puritanism, Victorianism, and various and assorted religious and cultural beliefs have conspired to rob us of the joys of one of the most delightful aspects of being human. Even within the confines and sanctity of marriage, many people in this country cannot find the sexual freedom to truly abandon themselves to joy! Amid such restricted and negative attitudes, is it any wonder that many parents feel that the natural penis is just too earthy and needs tidying and

## Men's Voices...

off, that's mine.' I am still envious of men who I see who are intact. I have always exercised in a local Y or gym and have seen thousands of boys and men in the showers over the years. The American male's penis is a ruined penis. In most cases, too much skin has been removed, thus during erection there is no sheath movement of the outer skin. Penis 'function' is then nonexistent. Some friends have shown me that their careless circumcision resulted in up to half of the glans being removed. 'Thanks a lot doctors,' we really appreciate what you've done for us."

S.B., 47, Atlanta

"At age 70, I will always remember the pain of my circumcision, at age 7, while under ether for a tonsillectomy. How I wish I still had my foreskin. I didn't know what had happened at the time. It's sad when we have no voice in a decision."

R.D., Wisconsin

"I am a male 24 years old. This is a personal and emotional subject for me, and I am having much difficulty in writing this. I am so angry and upset and depressed that I've been circumcised. How can someone think that they know so much that they can decide to surgically modify/mutilate my sexual organs without even consulting me? I remember (age under 8) being in the tub bathing. I had noticed a brown ring of tissue around my penis and (my mother was in the bathroom at the time) asked my mother what it was. She replied, 'That's where you were circumcised.' I asked why. She replied, 'To keep it clean.' I thought it was a poor reason. I have since my early teens wished to have my foreskin reconstructed. At that time, I had not heard of it ever being done, but I had heard of sex change operations and figured, by comparison, that foreskin reconstruction would be a piece of cake. When my first serious girl friend offered to perform fellatio on me I happily agreed. However, when it happened, I felt practically nothing; I thanked her and told her it was wonderful—a lie. I was disappointed, but I said to myself, 'It was the first time. Maybe I was nervous. And it was in the back

(continued)

## Men's Voices...

of my car—not the ideal place for an orgasm.’ A few months later, at the age of 17, I lost my virginity to her; it too was disappointing. I could not feel anything and did not have an orgasm. Of the 30 to 40 times I had intercourse with her I achieved orgasm/ejaculation only 4 or 5 times. I tried it both with and without a condom. It felt slightly better without, but not enough to matter, and I knew it wasn’t a good idea. Now I am with the most wonderful woman in the world. I’m deeply in love with her. She is sexy, has some erotic ‘naughty nighties,’ and my sex life with her has been much better than the others. At first it wasn’t, but she gave me time, and now my frequency of orgasm is up to about 1 in 4. This is great compared to before, but I still feel like I’m missing something. My hypothesis is that my lack of sensitivity is due to not only the physiological changes circumcision causes, but mentally as well.”

C.A., Sacramento

“I am a victim of circumcision. For many years I have resented: 1) the knowledge that something was done to me, which my mother said was ‘for my own good,’ and was probably really done to hurt me, and 2) declarations by my wife that uncircumcised men are more attractive and desirable than we circumcised types.”

E.W., Los Angeles

“The scars of circumcision are not only on the infant. A neighbor commented recently that she didn’t like ‘the circumcision thing’ and went on to recall that she had heard her new son crying continuously for two days after he was circumcised. He was in a nursery down the hall from her hospital room, but through two sleepless nights, she could recognize his voice among all the others. She was 89 when she told the story, her son 55. That’s a long time to carry feelings of guilt and inadequacy. What a pall to cast over what should be a pinnacle of joy!”

M.J., Illinois

sanitizing—as much as possible given the disgusting and evil nature of the thing?

If you think I’m overstating the negative attitudes held by some relative to the male genitalia, consider the commentary on ‘penile enhancement’ which appeared in the *Art Hoppe* column in the *SAN FRANCISCO CHRONICLE*:

“I’m appalled. What appalls me is that these surgeons are supposedly enhancing them [penises] by making them larger! This goes against every aesthetic credo. The penis is the ugliest of all human organs, uglier than ears, noses and even big toes. Enlarging it would serve only to enhance its ugliness. Not only is it ugly, but its conduct is despicable” (21).

While Art Hoppe’s extreme view is hopefully in the minority, there does seem to be a definite cultural bias against male genitalia. Note, for instance, the extent to which female nudity has become acceptable, from pin-up calendars to modern-day films. Not so with the male form. While there are magazines which feature male nudity and films which give fleeting glimpses, the male genitals are generally considered just too naughty, and those films which do include brief glimpses are considered far more explicit than those which include female nudity. It is not my intention here to make a plea for more films which included male nudity; rather, it is simply my contention that we do, as a culture, consider the genitals of the male to be somehow dirtier and more vulgar than those of the female. It is not surprising, then, that we favor a procedure that promises to clean things up—at least a little!

### What Happens to Mom and Dad When They Say Yes?

Earlier in this chapter, I related the case of a mother joking to the doctor about ‘letting the air out of it’ when talking to the doctor about her newborn son’s circumcision in spite of having seen him strapped down and crying. What allows a new mother to look with dispassionate interest at her baby son suffering like that and later make jokes about it? Clearly, some form of psychological denial is defending such a mother against the full emotional impact of the situation.

**Denial.** One major manifestation of denial is the need or tendency to trivialize. ‘No big deal,’ we often hear people say, sometimes about a truly traumatic event in their life. ‘At least I’ve got my health, or my job, or my family, etc.’ These statements, while perhaps true, often mask or deny the fact that great personal loss has been sustained. These are frequently the people which I see as a psychologist a few months or years later when they are having problems which just as frequently they do not understand at all. We then discover, in the course of therapy, that the buried and denied pain is finally surfacing in what appear to be unexplainable and unrelated symptoms.

**Humor.** Humor is indeed an effective denial mechanism. There seems little doubt that the mother in the case cited above got a great



deal of emotional distance from her baby's suffering by turning the situation into a joke. Furthermore, in the case of the stand-up comic, recall that it was the father himself doing the routine about his twin sons' circumcisions that kept the audience howling. He was probably also one of the men who walked around at the bris guarding his crotch; his humor allowed him to guard his feelings as well.

In replying to the 'Airborne Babies' articles in the AMERICAN MEDICAL NEWS, a physical therapist, who is the wife of a Massachusetts obstetrician, wrote: "It is hard to believe that a mother would make such a comment about her son's suffering, except in a case of pathological denial" (22).

**From Rationalization to Intellectualization.** When I was a young psychology student in the 60s, we often joked that the more we caught ourselves using rationalizations the better we got at it. Where once we were able to give ourselves and others one or two pretty good reasons why we had done some stupid thing, we were now able to give an elaborate defense of our action or decision including at least 10-15 major advantages to our stupidity. As a matter of fact, some of us used to boast, 'I can make my stupidity seem like the only wise thing I could have done under the circumstances!' We dubbed such skilled rationalizing, *intellectualization*.

Not long ago I was talking to a middle-aged circumcised male who is the father of a circumcised teenage son. He was decidedly in favor of infant circumcision from both a medical and a religious point of view as a Christian. When I pointed out to him that infant circumcision dulls the normal sensual penile responses, he replied, "Well, I guess it's a good thing I was circumcised; I'd hate to think of how much more trouble that thing could have gotten me into if it felt any better!" It is interesting to note that this rationalization came not only from a circumcised male but one with a rather severe penile deformity due to a botched infant circumcision.

**Cognitive Dissonance Theory.** We discussed this theory when we looked at the effects of infant circumcision on the circumciser. The same sort of effects are generally true across the board. In order to keep harmony among related ideas and thoughts, it is necessary to monitor incoming information. We know, for instance, that once customers select and purchase a particular make of car, or brand of audio sound equipment, TV, etc., they no longer want to hear anything negative about the brand of their choice or anything positive about the other brands they did not choose. They seek to maintain cognitive harmony and avoid cognitive dissonance by screening incoming information.

This effect is very detectable among parents who have elected to circumcise their son—especially since they cannot retract their choice! These parents frequently do not want to hear anything negative about

## Men's Voices...

"It is too late to save our son's foreskin. He was circumcised before he left the hospital. I didn't want it done, and refused to sign the consent. But everyone (wife, her parents, doctor, nurse, etc.) made me feel that I was depriving my son of the benefits of modern hygiene. So I agreed, stipulating to the doctor that I wanted only the very minimum amount of foreskin removed from the end to make Ron's foreskin retractable, to be sure to leave enough foreskin to cover half or more of his glans. I might as well have asked the doctor to remove as much as possible, because that is what he did. Ron's frenulum is gone and there isn't enough skin left, even fully flaccid, to cover the groove behind his glans. Half of the skin on the shaft is a scar. I complained, and the doctor said the wide scar is normal. It will get narrower and less visible with time. He also says that all boys are being circumcised very short nowadays. He also said that the reason he couldn't save any of Ron's foreskin was that Ron's foreskin was abnormally thick and would have been non-retractable. I think he took it all to show me who was boss—that I couldn't or shouldn't try to tell him how to do his job."

D.M., Chicago

"Unfortunately I'm another son of another new mother who fell into the automatic circumcision trap. Makes me wonder where the hell my father was or if he even knew what was going on. I want it back!"

J.C., California

"I am one of the many men in this country who was mutilated as an infant. I've had a lifelong longing for that part of me that was so cruelly stolen from me as a defenseless child."

D.P., Iowa

"The bastard (the doctor who circumcised me)... if I could get my hands on him now, I would cut his f---ing c--k off."

G.P., 57, Arkansas

## Men's Voices...

"I am 32 years old, circumcised at age 17. I was not circumcised against my will. I didn't want my foreskin, even though it was loose and rather short, retracting very easily. The psychological effects of being uncut were depressing for me. Everyone I knew was circumcised, except for a few orphans who attended my school and, of course, myself. Talk about feeling out of it. The best, brightest, most handsome boys took great pride in showing off their large, beautifully sculpted penises. My own penis was equally as beautiful, but my foreskin made me ashamed to be seen in the locker room naked.

I do not believe in infant circumcision. I do believe in a consenting man's right to do whatever he pleases with his penis once he realizes who he is and what it is he wants, and his personal relationship with his society. I was circumcised because I wanted to be, and there is no turning back, period. Free will is what it's all about. Only the consequences may not be what one bargained for. I think that in the final analysis one has to be a bit willing to see both sides of the issue, especially among adults. Children should be left intact to decide for themselves. Don't rob them of the choice."

F.L., Dallas

"My parents not only resisted medical advice for circumcision but also let my foreskin loosen at its own slow rate. I was about 12 before my urethral meatus was visible and 16 before I saw the corona of my glans. Even with this slow loosening of the foreskin, I never experienced irritation or inflammation. Before becoming sexually active, I spent a few minutes per day over a period of months gradually stretching the foreskin by hand until it would easily retract. This approach was simple, painless, and effective. There is a wide normal range, and my own experience convinces me that there is no reason to be too quick with the knife."

T.L., Virginia

infant circumcision or positive about the intact penis. A short time ago, I was talking to a family which included a young circumcised father and two small circumcised sons. Actually, I was talking to the mother, aunt, and grandmother of the two little boys. The father was sitting on the couch absorbed in a newspaper. During our conversation, the subject of this book came up, and I was explaining my stance on infant circumcision. At some point, the father looked up from his newspaper and announced, "Well, I read somewhere not long ago that it is a good thing!" End of discussion! It's a case of the old adage, intended to be a joke, 'my mind is made up, don't confuse me with facts!'

Again the question: If parents have made an irreversible decision relative to their child's circumcision, and they now rely on denial, rationalization, and information screening to maintain harmony within themselves, what are the ongoing effects of these mechanisms on their individual personalities? And, do such mechanisms generalize to involve other issues and areas of their lives? Again, these questions are based on speculation. But, we do know from research that parents tend to respond much more quickly to their little girl's plea for help than to their little boy's request for attention (23). We do know that parents teach their little boys not to cry or to display their feelings in ways that are often tolerated or even encouraged in little girls. There does seem to be a need for the little guy to prove to them that he's a real little man and can 'take it.' After all, because of their decision, he had to!

Before leaving the issue of the possible effects of infant circumcision on parents, I would like to say that the sort of defending we have been discussing is not the only alternative for parents who chose to have their son, or sons, circumcised. After all, we are all products to a large degree of the culture in which we grew and developed. For many of us, males and females alike, circumcision was not thought to be a choice; it was a 'necessity.' It was how little boy babies got readied for life along with cord cutting, measuring, eyes washing, foot and hand printing, etc.

In light of these simplistic, cultural beliefs, if new information does cause us to change our opinion as to the advisability of infant male circumcision or our right as a parent to have made that choice for our son, apologies and explanations both to ourselves and our son go a long way toward restoring cognitive harmony along other lines than the typical defense mechanisms: "I was uninformed and made a wrong decision." "I love you and want you to forgive me." "Is there anything you would like to ask me about your circumcision?" Believe me, such honesty can be very healing for all parties concerned. And, given the fact that over 50% of the men who answer the UNCIRC questionnaire note that they resent one or both of their parents for their

circumcision, such an approach might well heal breeches in the family structure that many parents do not even know exist. This lack of awareness seems especially likely since most of the respondents indicate that they have never discussed their circumcision or their feelings about it with their parents.

### Infant Circumcision and the American Male

When I first began to sort through topics for this section of this chapter, I assumed I would only need to talk about the effects of infant circumcision on circumcised males. I realize, however, that this is not true. It is not true because every year in this country a small percentage of intact males have themselves circumcised to fulfill a lifelong need to at last fit in, to at last be like everyone else. So, we must at least look at what motivates these males to choose to have themselves circumcised as well as looking at the possible effects of circumcision on the male circumcised as an infant or young child without his consent.

### Choosing Circumcision Later in Life

I do not question the *right* of an adult male to consent to his own circumcision, regardless of anyone else's opinion about the value of the intact penis. If the male of legal age to consent makes a voluntary decision for his own circumcision, that is his choice to make. Once again, however, the psychologist in me cannot simply let it go at that. I want at least to ask, 'Why?'

It has been rather widely publicized that Elvis Presley had some rather self-deprecating remarks to make about his uncircumcised "hillbilly" penis [terminology edited by JB]. The fact is that UNCIRC gets letters every so often from uncircumcised males wanting to know why any circumcised male wants a foreskin when their own attitude toward their foreskin is so negative. We also hear from men who had themselves circumcised as adults in order finally to fit in and who then go on to say, "Oh, how sorry I am!" (24).

It is not my purpose here to debate the issue of the intact *vs.* the circumcised penis for the *consenting adult*. Rather, I seek to understand what motivates a male with an intact, functioning, healthy foreskin not only to wish it removed but to undergo the surgical procedure necessary to accomplish the fact.

In discussing the motives of parents who circumcise their sons, we looked at the motivating nature of approval and conformity needs. And we noted that these needs are so basic that desired behaviors are often reinforced by nothing more than a smile. In the same vein, there is a growing body of current research which seeks to investigate the attitudes of children of minority races toward their own uniqueness. Researchers who asked black children to pick out the *good* doll, the *pretty* doll, the *honest* doll, etc., were shocked to discover that these children over and over again chose the white doll over the black doll (25).

### Men's Voices...

"I consider myself to be a fairly educated and open-minded person, but upon reading this literature I began to realize that I never made an effort to evaluate circumcision—as it related to me and to society as a whole. The more I read, the more I began to realize the amount of pain and resentment I have concerning my circumcision. The pain is not mild, to say the least, and I think denial has played a large part in its suppression. I didn't want to know that something was done to me by supposedly caring and loving individuals that contradicts the most basic ethical and philosophical teachings.

I have a very difficult time dealing with the fact that I have been permanently altered, against my will, for the rest of my life. An unaltered body is an impossible dream for me. Sitting idle and feeling hopeless are options I don't wish to employ in my dealings with this, therefore I have decided to take action to deal with this issue. It seems that restoration, which I have started, is an important part of that action, especially in the healing process, as it provides a good approximation of what was so forcefully taken away. The shift of power back to me will probably do wonders for my self-image, both physical and psychological."

R.B., Washington

"My circumcised penis has become hypersensitive to the touch and I must wear a gauze bandage on myself at all times to help relieve my painful situation. Are there any operations or restoration techniques that can restore me back to the natural way I should be and eliminate the pain I must endure on a daily basis?"

P.N., Texas

"I think among the many reactions and feelings I had as I read the book, the idea that once the glans is covered it has 'come home' is the most telling. To feel my corona safely protected is one of the most satisfying sensations I can imagine, and it's not even erotic! I'm just happy it's there!"

T.C., Indiana

### Men's Voices...

"Your book arrived promptly and it was much more than I had hoped for. Is this book ever going to change my life! I thought I was the only one who thought that the uncircumcised penis was more masculine. Now I am no longer ashamed of it. I feel like I have been freed and empowered. In any event, I accept my circumcised state without anger, though I wish with all that is in me that it had not been done. Now there is something that can be done about it and *I am going to do it!*"

As you predicted in the book, circumcision over time diminished the sensitivity of my penis head and while there is a little sensitivity left, my most intense feeling comes from stimulation of the little area under the head at the front which I think is the 'frenulum.' I really think this is a shame and look forward to the return—soon I hope—to much wider sensitivity. This has already begun, I think, since it seems that I can feel the water drops when I am in the shower. I sure do look forward to feeling more than water drops."

R.M., Florida

"I am a victim of infant circumcision, and even though I am 55 years of age, I am forcefully and painfully reminded of this atrocity, perpetrated upon me deliberately by my mother who ordered it done, every time I take a shower, dress and undress, look at myself in a full-length mirror, or masturbate. And my studies indicate this atrocity even takes all the fun out of the last item above. I am still dealing with deep anger and rage over this."

T.W., Washington

"After thirty years in the natural state, I allowed myself to be persuaded by a physician to have the foreskin removed—not because of any problems at the time, but because, in the physician's view, there might be problems in the future. That was five years ago, and I am sorry I had it done now from my standpoint and from what my female sex partners have told me. For myself, the sensitivity in the glans has been reduced by at least 50%. There it is unprotected, constantly rubbing against the fabric of whatever I am

(continued)

Members of the black community have responded to such findings by redoubling their efforts to enhance the self-image of black children and to instill pride in the joy of being black. I would suggest that men who seek to alter the body in which they have grown up when it is perfectly natural and functional are victims of much the same sort of social ignorance and lack of awareness that plague minority children in a society often indifferent to their feelings about being different from the majority. How to help a child feel positive about being uniquely different is a challenge our society has not as yet met. And, we don't talk about different styles of penises either!

### Evidence for Possible Psychological Effects of Infant Circumcision Upon the Circumcised Male

I noted at the beginning of this chapter that no ongoing longitudinal studies are known to exist which are asking questions about the possible long-term effects of infant circumcision upon the individual. There have been some studies, however, which do seem to bear upon the subject, at least in terms of short-term effects.

**Research Evidence for the Effects of Infant Circumcision Upon the Individual.** Using sound spectrographs, P.F. Ostwald and P. Peltzman studied the differences between infant crying due to pain and crying due to other causes. They note:

Our attention has been focused on the distress cry of infants. We have recorded numerous distress cries resulting from routine medical procedures such as taking blood samples and minor surgery such as circumcision. The distress cry is louder, longer, and noisier than the hunger cry. It also tends to be irregular, with more interruptions and gagging (26).

The significance of this evidence that the circumcised infant is in pain and has been traumatized will be important to bear in mind as we consider research data relative to birth trauma.

Observation and data collected from premature infants demonstrate that newborn experience has lasting effects upon the child. Often premature babies are left in the incubator for extended periods of time. Some babies will go largely untouched for days at a time; others may be handled and caressed frequently by either parents or nurses. Dr. T. Berry Brazelton found that,

... the babies who are handled 'do nearly twice as well' as the untouched newborns, that they 'gained weight, began to develop more quickly.' These results showed up after one year (27).

In the early 70s, two research projects investigated the sleep patterns of male infants before and after circumcision. In one study, the circumcisions were done using the Plastibell technique (28), and in the other, the circumcisions were done using the Gomco clamp (29). The results of the two studies were parallel regardless of the circumcision technique used. After circumcision, the babies spent

more time awake in a fussy-crying state and slept less. During the recovery period, 1 1/2 to 7 hours after circumcision, the babies fell asleep more quickly and slept longer than before circumcision. The authors suggest that 'stressful stimulation' leads to withdrawal, or sleep, in the neonate.

**Birth Trauma: Some Recollections, Some Research, and Some Questions.** More recently, we have been hearing a great deal of speculation raised by the therapeutic procedures of Primal Therapy. This therapeutic process was conceived to allow the individual to complete the healing process relative to early trauma and pain. The number of reports which relate to both traumatic birth and infant circumcision is growing. For example, Dr. L.A. Pam has recounted his 'relived' circumcision experience as an infant. He describes his terror, the immediate pain, and the pain that lasted for days until he was healed. He further describes many feelings and faint recollections which lingered all during his childhood and early adult years (30).

Briggs reports the case of a mother's conversation with her 4 1/2-year-old son after he tripped and fell. The mother states that, after she had made sure that the child was really okay, she said, "What hurts?" He was crying, but not hysterically:

Child: My penis. It feels just like when the doctor cut the skin off.  
 Mother: When was that?  
 Child: When I was a little baby.  
 Mother: What did you do?  
 Child: Nothing.  
 Mother: Did it hurt?  
 Child: Yes!  
 Mother: Did you cry?  
 Child: Oh yes, I cried hard.  
 Mother: Who was there?  
 Child: The doctor and the nurse.  
 Mother: Where were you?  
 Child: In a room on a hard table that can go up and down.  
 Mother: How did they do it?  
 Child: With a very sharp knife.  
 Mother: How did you keep from wiggling?  
 Child: They had straps around me here (indicating his chest) and here (indicating his thighs).

After this point in the conversation, the child had several questions as to why the parents had decided to "let the doctor do it." Later, the mother confirmed the details which the child reported relative to the location of the straps, etc. (31).

In 1987, Dr. Bertil Jacobson came from Stockholm to present a paper to the Pre- and Pari-natal Psychology Congress. The findings he reported were from research which had been done to study the long-term effects of traumatic birth on behavior later in life.

## Men's Voices...

wearing. In a sense, it has become calloused. Intercourse is now (as we used to say about the older, heavier condoms) like washing your hands with gloves on...I seem to have a relatively unresponsive stick where I once had a sexual organ."

S.J., Denver

"Orgasm, which I feel as deep muscular sensations, has not changed, but my perception of intercourse is very different. Sharp, strong sensations from the surface of my glans and upper shaft have given way to much duller sensations of pressure and warmth under the skin."

T.B. (circumcised as an adult)

"The sexual differences between a circumcised and uncircumcised penis is...[like] wearing a condom or wearing a glove...sight without color would be a good analogy...only being able to see in black and white, for example, rather than seeing in full color would be like experiencing an orgasm with a foreskin and without. There are feelings you'll just never have without a foreskin."

R.G. (circumcised as an adult)

"I did not realize that I was circumcised until I was in 8th grade. I attended a large school in Jr. High and saw lots of penises in the locker room. Of the several hundred guys in the class only two were different. They had a blunt end on their penis. I called it a 'burnt tip' in my mind, not knowing what had happened to them. I assumed that it had been burned, damaged or something to get rid of the nice plump head that I had. Later while swimming naked with my father, I realized that he also had a 'burnt tip' to his penis.

My father taught my Sunday school class. One day the passage of scripture talked about circumcision. I did not know what circumcision was and it was not really explained in class. When we got home my father completed the explanation. He told me that I had been circumcised 'automatically' at birth like most of the boys I knew. He explained that because he had been born at home, he had not been circumcised. He would have preferred that I too was uncircumcised, but the doctor cut me

(continued)

### Men's Voices...

immediately after birth without asking any questions and it was too late. I found out that day that I and most of the other boys were the ones who were damaged.

The penis is a private part. The glans penis is the most private part. It is the center of personal excitement for the man. When he is uncircumcised it is kept private. When he is circumcised, his most private part is exposed for everyone to see. I am glad that being uncircumcised is becoming more popular and that new parents are less likely to be talked into an unnecessary circumcision."

W.M., Ohio

"Before I was 10 I had seen at least two social studies documentaries at school which mentioned the efforts of the United Nations doctors to stop the ritual of sexual mutilation of children in African tribes. I remember thanking God I lived in an educated country where such things weren't possible. When I was 12, my parents left out a sex education booklet and I learned that I had been circumcised. The knowledge hit me like a literal hammer blow to my head. I felt betrayed by my parents and never trusted them again. I never discussed this with them.

What are my thoughts now on circumcision as a 37-year-old adult with a successful career and a stable heterosexual relationship? There is barely a more evil act of violence than the sexual mutilation of helpless children, and there is no reason—religious, medical, or cultural—to ever justify it."

K.S., Florida

"I am sure that you got my first letter. A strange thing happened as I wrote it. As I mentioned, I had never told anyone of my feelings about my circumcision. As I sat typing that letter I began to shake, and by the time I was done, as I reread it, I had a tremendous feeling of loss and anger about being violated. The feelings were so intense that they really startled me, and I can only imagine that I have kept them buried for years. This may sound kind of silly, but later I went back and

(continued)

Birth record data were gathered for 412 forensic victims comprising suicides, alcoholics and drug addicts born in Stockholm after 1940, and who died there in 1978-1984. Comparison...showed that suicides involving asphyxiation were closely associated with asphyxia at birth, suicides by violent mechanical means were associated with mechanical birth trauma and drug addiction was associated with opiate and/or barbiturate administration to mothers during labor (32).

The researchers go on to speculate that these associations may be due to a mechanism something like imprinting.

Since this work was done in Sweden, infant circumcision was clearly not a part of the research considerations. Dr. Jacobson, however, in communications with Marilyn Milos of NOCIRC, indicated that there is reason to suspect that early circumcisions might well impact upon later violent, self-destructive behaviors in the male. He has offered his input should a parallel study be set up in this country to test such an hypothesis.

### Suggested Personality Trends Due to Infant Circumcision

The defense mechanisms and cognitive biases which we looked at when we considered the possible effects of infant circumcision on doctors and parents are probable factors here as well.

**Denial.** There is no other childhood trauma so consistently ignored in our culture as early circumcision. Parents simply do not talk about it, the doctor does not talk about it, and the child learns not to talk about it. As a matter of fact, UNCIRC, NOCIRC, and NORM frequently get letters from men who report that they are not sure whether or not they are circumcised. Drs. Lilienfeld and S. Graham reported that, in a study designed to examine any possible link in cervical cancer in women and the circumcision status of their husband, 34.4% of the men were in error in respect to their own circumcision status! (33).

Not only do many men not know their circumcision status, many who are clearly circumcised do not perceive their own circumcision scar. It seems hard to imagine, but many men do not *see* that they have a scar on their penis—even in instances where it is clearly visible. It is not too uncommon for a man to indicate on his completed UNCIRC questionnaire that he does not know where on his penis the circumcision scar is even though he is sure that he is circumcised. One man complained that, until prodded by an anti-circumcision activist, he never *knew* he had a scar. Ironically, his wife knew! Denial does indeed provide 'rose-colored glasses.'

**Humor.** As I listened to the stand-up comic, cited above, entertain the crowd with his recounting of his twin sons' circumcisions, I listened for the laughter of the men in the audience. And they certainly did laugh! They laughed especially at the line about the men at the bris

guarding their crotches. If we only concern ourselves with the men's use of laughter to deal with their own circumcised state, perhaps a little denial is understandable. But, if they keep on laughing, they'll laugh right through their own son's circumcision. And, that's a different matter.

**Introjection.** Recall, this is the mechanism by which the individual takes on the values of the surrounding social environment. By means of this defense, the circumcised male comes to value and appreciate his circumcision. He often builds rather elaborate explanations as to the good reasons it was done to him. The effects of this process are at least twofold. One is that the male who uses such a defense will almost certainly favor circumcision for his sons and even their sons. And the other is that he may well develop a sense of needing to atone and make up for what he perceives as his true, unacceptable self. After all, he came into this world with a dirty, smelly, naughty, and unhealthy penis which had to be fixed before he was acceptable to his parents and family—what else may need fixing?

**Rationalization.** This is the 'after-all-they-thought-they-were-doing-the-right-thing' syndrome. John Bradshaw regularly points out in his lectures that healthy growth will eventually include a measure of understanding and forgiveness of abusive parents; but, he warns, that fact should not be used too soon by abused individuals as a defense against dealing with their own pain and woundedness. The same message can easily be applied to circumcised males in our culture. It is healthy to recognize the frustrating helplessness, get angry enough to acknowledge the pain, grieve over the physical loss, and then move on to embrace life. Remember, we psychologists have a thing about repressed pain and anger. It's going to come out somewhere and perhaps even spoil the quality of life in some way or spoil a valued relationship. Why not deal with the real cause of our anger and pain rather than going through life inventing situations and reasons so as to vent the repressed anger and frustrations?

As I wrote the suggestion above that the circumcised male should 'grieve over his physical loss,' I was immediately aware that if I were writing such an instruction to women who had lost a breast, no one would blink an eye! But my suggestion that a circumcised male grieve over the loss of his foreskin is apt to send many readers—males and females alike—into peals of laughter (another defense mechanism). After all, why should any male care whether or not his body is whole? Snips and snails and puppy dog tails aren't supposed to have the same feelings as sugar and spice and everything nice!

**Emotional Insulation.** Big boys don't cry—about anything! With enough layers of indifference wrapped around them, most men can face anything, anytime. Anything, that is, except feelings. As a psychologist, I am aware that circumcision is just one of many painful

## Men's Voices...

rewrote the experience in great detail with even more dramatic feelings. It was like I was releasing a part of me that has hurt for years."

H.J., Virginia

"I ordered the *Joy of Uncircumcising* about two months ago in an effort to undo the terrible thing I did to myself. I had myself uncircumcised two years ago in an effort to improve my sex life and to make my penis look just like every other guy's. I wish I could have had an opportunity to read your book prior to my going under the knife, for all the good things I thought would happen didn't, and all the bad things, that you so well point out in the book, did.

I knew things were going wrong after my circumcision, but everyone from the urologists to my wife to my physiologist just kept saying, 'It's all in your mind.' How happy I was to read that things such as stitch tunnels can occur. I had two of them, and the surgeon just told me I was too critical of the results. The gradual loss of pleasure sensation and the later difficulties in achieving orgasm now also make sense. For my first 40 years of life I was always under the impression, as I saw men in locker rooms, that a circumcised penis must feel and be better. How wrong I was! If I knew then what I know now, I would have never once felt embarrassed or envious of the other guys—heck, I had the best and didn't know it!"

T.M., Illinois

"Your book made me weep. And miserably, I *did weep*. It also struck some humorous chords in me at times. But mainly, it pulled feelings of shame, physical and mental pain, and helplessness from within my soul. I have tried to suppress these feelings since I was last told by my mother when I was 7 or 8 years old to 'stop complaining about your circumcision.' The silenced feelings have only grown and hurt more ever since that time. I know for a fact, 'Big boys do cry.'"

F.G., Colorado

facts, experiences, and issues of life from which the typical American male is ‘comfortably insulated.’

**Cognitive Dissonance.** We looked at the cognitive tendency to avoid dissonance when we considered the effects of infant circumcision on doctors and parents. What are the effects on the circumcised male, himself?

Cognitive Dissonance theory has an axiom which says: “Rats and people come to love the things for which they have suffered” (34). Stated in another way, having paid a great price, the individual must see the thing for which he or she has suffered as highly valuable and worth the ‘price paid.’ Accordingly, it is predictable that circumcised men will need to see value and benefit relative to their own circumcision in order to keep cognitive harmony with the fact that their foreskin was removed without their consent. I quoted earlier a middle-aged male who guessed he should be grateful if indeed circumcision had reduced his sexual sensitivity—even though he has a deformed penis due to infant circumcision—because, ‘just think how much trouble that thing could have gotten me into if sex had felt any better!’ Such cognitive gymnastics are typical for the individual who must see the ‘silver lining’—or cry! or scream!

Finally, what are the long-term effects on the male who has adopted one or more of these defensive modes to deal with his circumcision? To what extent do such defenses block out other facets of life and filter out other feelings because the only ‘safe place’ is not to feel?

Men’s groups are forming around our nation to help men regain their inner losses in a society that has been very damaging to men and boys. Such spokesmen as Robert Bly, Sam Keen, Shepherd Bliss, Jed Diamond, and Warren Farrell and such organizations as Men’s Rights, Inc., the National Men’s Resource Center, the Redwood Men’s Center, and a host of workshops and groups are saying to the men of this nation that it is time to listen inside yourself so that you can be more attune to the world around you. In fact, the most universally shared wound of males in America is the wound of their circumcision at the hands of another, and many of the leaders and organizations noted above have now voiced their concern over the harmful effects of routine circumcision. If you are a circumcised male, perhaps it is time for you to listen inside yourself for the cries of indignation and pain which may well be hidden there so that you can move on to greater wholeness for yourself and also help other generations of males to live in a whole body which is, after all, our shared birthright.

Now comes the good news! Men all over this nation, and the world, are regaining control. Not only is there an increasing number of men fighting for the rights of males by speaking out against infant male circumcision, every year more and more men are deciding to do all they can to regain as much as possible of their own stolen birthright—a whole body. In the next 11 chapters, we will look at modern-day foreskin restoration: its history, its motives, and its techniques. There is indeed real hope!



# 11

## Why Men Today Want to Uncircumcise

*“From the first time I saw an uncircumcised penis I’ve felt deprived.”*

**J.A., Denver**

After a hundred years of both vilifying and trivializing the foreskin, the mere suggestion of its restoration is apt to bring the retort: “Why?” In this chapter, I want to share with you some of the observations men make about being circumcised and some of the more common reasons they give for wanting to restore their foreskin. Most often, their reasons suggest that they consider the natural penis the ideal and that they view it as the model for restoration. In addition, I want to discuss some of the social conditions which confront the male who restores his foreskin late in the 20th century.

### Common Reasons Men Give for Restoring Their Foreskin

At UNCIRC, NORM, NOHARMM, and other circumcision and restoration information centers, the worldwide inquiries and responses now number in the hundreds each month. In both the initial inquiries and the follow-up correspondence or questionnaires, men often take the opportunity to relate their reasons for seeking restoration. The statements range from a simple, “I want it back!” to elaborate explanations of the pain, frustration, and anger which many of these men feel.

**1. Aesthetics.** The 60s brought a new appreciation for ‘things natural.’ Many ‘hippie’ parents did not have their sons circumcised for the simple reason that it was not natural. While the national circumcision rate continued to climb into the early 80s, so did a more subtle appreciation for things natural. When one considers the resurgence of folk crafts, natural foods, and environmental concerns, it seems likely that the 60s have indeed left a legacy. One of the less recognized or acknowledged consequences of that legacy is the growing awareness of many circumcised males that their circumcised penis is not natural. For these males, foreskin restoration offers hope that they too can one day *appear* to be unaltered and, thus, natural.

**2. Sensitivity of the Glans.** Whether this enhanced condition of the glans is labeled ‘sensitivity’ or ‘sensual responsiveness,’ this

### Men’s Voices...

“I was born in 1945, but I had a little bit of skin left after my unnecessary circumcision; just enough to cover the glans when my penis was very cold, for example, after swimming in a cold lake, or skiing into a cold wind.

As a child I noticed both of my grandfathers had a flap of skin covering the end of their penises. Likewise my stepfather. Neither my brother nor I did, and neither did we have the hair of the adults. I came to the obvious but wrong conclusion that one grows foreskin when one grows pubic hair. Well, so much for childhood delusions. The point of the story is that I always wanted to have a foreskin, or at least to know what it was like to have one.

About at the age of 38, with an intact son (then six years old), I began stretching my somewhat loose penile shaft skin so as to cover the glans. I started one day when, after a morning shower and before leaving on a business trip, my penis shaft had retracted so that the skin covered the glans like a normal foreskin. I decided there and then to tape it in that position and see if it would stretch into a permanent foreskin. The first day I used ordinary scotch tape, later clear plastic bandaging tape, finally settling on band-aid ‘Shear Strips’ as being all around most successful.

The first few days were less than comfortable as my penis felt like it was being pushed back into my body, and the tape hurt a little. The glans actually felt slightly numb, perhaps due to reduced

*(continued)*

### Men's Voices...

tactile input. Two strips of tape or two band-aids were required at first, and they frequently tore loose during nocturnal erections. New band-aids were required each day.

After about three weeks, sufficient stretching had occurred that the tape didn't tear loose, and the stretched shaft skin seemed to have produced partial coverage of the glans when fully flaccid. Some smoothing of the glans was noticed, and no more discomfort except for pubic hair caught in the band-aid.

After about one year, a single band-aid was sufficient. Nocturnal erections still produced stretching and could pull the band-aid loose, particularly as the adhesive lost its effectiveness after several days. Coverage was about 50% of the glans when fully flaccid.

Now at the age of 41 (after three years) the skin covers 100% of the glans when fully flaccid, but less than 100% when in a normal slightly inflated state, and will remain for hours in place, but not permanently. Incremental stretching is slight each year, and I would like a more rapid pace. To keep the foreskin in place at all times (even when aroused) still requires a band-aid from side-to-side or front-to-back. But I've enjoyed three years of having a covered glans as nature intended.

I am happy to report that I prefer the covered state. After 38 years of exposed glans, its surface was rough, fissured, and insensitive, much like permanently chapped lips. After three years of a more normal state, my glans is approaching a smooth, glistening appearance with heightened sensitivity. The color was formerly like the palms of my hands, and is now a light purple, very much like that of my intact son. Hygiene is no problem; I slip the skin back when urinating and rinse with water in the shower daily. No soap is needed and no significant odors or buildup of any kind occurs. My wife comments on a slight 'sticky' texture (due to normal skin oils which no longer rub off onto my clothes), and also she comments on the improved speed of my lovemaking (I formerly took forever, such that she got physically sore while waiting for me to finish.)

(continued)

benefit of restoration is both the most frequently reported reason for seeking restoration and the most frequently reported result of restoration. The word somehow gets around, 'a covered glans is a happy glans!' Evidence from the features of the glans of intact males—texture, color, moisture, etc.—suggests that nature intended the glans to be an internal organ. Men considering foreskin restoration often voice a desire to regain as much of the natural sensitivity and as many of the natural features of the intact penis as possible.

**3. Sexual Stimulation and the Sexual Functions of a Restored Foreskin.** In our discussion of the natural penis in Chapter 2, we discussed several functions of the natural foreskin. And, in Chapter 13, we will discuss the need for honest, realistic expectations relative to the restored foreskin. It is, therefore, enough to say here that many men who seek to restore their foreskin report that they hope that their new foreskin will provide an enhanced and more natural means of stimulation for both their partner and themselves than their circumcised penis with no slack, mobile skin provides.

**4. Sense of Wholeness.** This benefit of restoration is closely related to the desire to appear natural which we discussed above. Not only do some men believe that the intact penis is more aesthetically pleasing and more natural, they feel more *complete* with a penis which appears normal—even though in some ways the effect is simply cosmetic.

I'm appalled by the lack of awareness of even the most basic psychological needs on the part of some otherwise educated individuals. When Dr. Edgar Schoen of the American Academy of Pediatrics [AAP] Task Force on Circumcision first heard about foreskin restoration in 1987, he was moved to write a four-stanza ditty in which he sarcastically derides foreskin restoration in some truly bad verse. He later quotes his ditty in his response to Dr. Goodwin's 1990 article in which Goodwin reported his 'uncircumcising' technique (see Chapter 20). Among Dr. Schoen's various comments relative to restoration and the presence or absence of a foreskin, he states, "...cosmetic appearance would not appear to be a factor *at this anatomical location* in our society" (1). (Emphasis JB) I am especially alarmed by such an obvious lack of awareness of or concern for the basic human need for wholeness, since Dr. Schoen served as *Chairman* of the AAP Task Force on Circumcision!

As noted earlier, if we were talking about restorative procedures for a woman who had lost a breast, no one would even question the validity of her desire to *appear* normal. And, in all candor, it must be pointed out that very careful scrutiny will usually allow detection of most restorative measures which involve external scarification. Nonetheless, the results of modern breast reconstruction are often satisfy-

ing enough to restore a real sense of wholeness to the woman herself. The same results, and limitations, are true of men who restore their foreskin. We're just not accustomed, as yet, to thinking that men have such feelings and needs, but they do.

In the late 1980s, I was teaching a course in the theories of sex therapy at a small private college. In preparation for talking to the class about the possibility that in the future they might be called upon to counsel men who are negatively affected by their circumcision, I interviewed 15 male students (ages 23 to mid-40s) on a volunteer basis. The questions I asked each student were very simple. After asking their permission and cooperation, I asked such questions as: "Are you circumcised?" "How do you feel about your circumcision status?" "Were you ever made fun of?" All of the males I interviewed were, in fact, circumcised, and none reported an awareness of negative feelings about that fact.

Eighteen months later, I taught the course again. Two or three of the students I had interviewed had not taken the class earlier and were now enrolled in the course. I presented my material, and then reported to the class that I had earlier polled 15 male students and that, in all candor, none of their responses indicated concerns regarding their circumcised state. I was about to go on with my lecture when a 24-year-old student, I'll call him Bob, spoke up and asked if he could talk to the class for a few minutes. He volunteered the information that he was one of the students I had interviewed and that indeed he had told me that being circumcised did not bother him in any way.

Bob then went on to say that he had gotten married in the intervening months since our interview. He further noted that his strict religious values meant that he had married as a virgin. It was obvious from his remarks that his religious background was in no way preventing him from currently enjoying his new marital state. But, he went on to say that, in his discoveries of the joy of sex, he had become keenly aware that his new wife brought to him a fresh, unaltered body just as God had designed it. While he, on the other hand, had an altered, disfigured body to offer her. I often wish I had a tape recording of his simple, honest story. I'd like to play it for those doctors who still maintain that the effects of circumcision are so trivial that men in America simply do not care one way or the other about being circumcised. In fact, after several years of working with circumcised men, I now know of numbers of men who had little or no awareness of their pain or anger until the issue was brought out into the open and it became acceptable to feel and care.

### **Psychological Motives for Foreskin Restoration**

Psychological motives are those less obvious need states which often underlie the 'reasons' we give for the things we do. We have been

### **Men's Voices...**

Am I embarrassed to have a foreskin? Heck no! But the band-aid still looks a bit odd."

F.W., St. Paul

"Why this new-found (later in life, anyway) fascination with a piece of skin? I am not certain; it is probably a combination of many things: return to something natural, return to something rather unusual in my generation, looking to regain lost sensitivity, resenting the fact that there are a few patches of skin missing from my glans, the results and additional scars of the circumcision process, a genital modification process under my control.

Unfortunately, my experience in the field of foreskin restoration is both undocumented and covering (intermittently) a period of several years. For the most part, surgery has been totally ruled out: expense, scarring, and uncertain results. (I have been intrigued by a process a furrier would use in making a fully-let-out coat). I imagine the stitch/scar pattern from that technique would be something to behold! This is in the realm of fantasy for me, not reality. When (or if) major stretching results are achieved, I would consider the 'tuck,' if that was the only means of keeping the skin forward or closed, and if it could be done ventrally as opposed to dorsally (which I think is the usual procedure).

For me, stretching is the logical method of choice, although I do realize that I might not be able to achieve the results (length or appearance) desired. The UNCIRC method seems well thought out and demonstrated as effective."

A.D., Minneapolis

"Infant circumcision has turned out to be a personal tragedy for me. At 37, my circumcision scar is the largest and only immediately apparent scar anywhere on my body. I'm resentful, upset, angry, and now embarrassed about being circumcised because it is a living symbol of senseless violence, oppression, ignorance, and greed, which I have been forced to carry on my body for 37 years. The more I ponder my own circumcision and that of others, the more my heart and mind rage against it. I'm grieving for

*(continued)*

### Men's Voices...

myself and others who were, are, and will be violated in this way. Infant circumcision is to me a truly vile practice defying all compassion and reason.

I have experienced continued sexual sensitivity problems. During the AIDS crisis I have worn a condom which has proven to make any climax I have expected impossible. After a few weeks of practicing a method of foreskin restoration, I'm convinced that my main problem was circumcision in combination with friction from clothing because I have lived a very athletic lifestyle for many years. The constant friction probably further desensitized me. I was able to completely cover my once barren glans with skin during about the second week and noticed suddenly that a major irritation was gone. Since then, other improvements have occurred. The color and texture of my glans has changed to more nearly match the rest of me, and its crevices and calluses are less apparent each week. The glands in the area have begun to produce normal lubrication, and my nose at times catches a faint whiff of natural male aroma, which rather than being unpleasant, it is pleasantly reassuring. Now I cannot leave my glans uncovered because clothes irritate it so much that I am unable to endure it for long and develop inappropriate erections from the friction if I move around too much. I can conclude from my experience so far that the normal covered or intact state is greatly superior to the uncovered or circumcised state for almost any human male. I feel that anyone who says that infant circumcision has no negative lifelong effects or is 'minor surgery' is either ignorant or lying, perhaps both.

What will be the future social implications of infant circumcisions done in the next few years? What will be a boy's reaction when he discovers through contacts with intact boys that a major piece of his anatomy is missing for no apparent reason? I feel that when such a person learns the complete truth it could potentially weaken or destroy family relationships. Even I at age 37

*(continued)*

discussing the typical reasons men give for seeking restoration; here I want to discuss some of the possible underlying motives for their desire to restore their foreskin.

**1. Body Image.** We discussed above the desire for a sense of wholeness and the lack of such a sense associated with circumcision. Here I want to talk about a self-perception which operates largely at an unconscious level and is often not altogether supported by reality. We hear a great deal today about thin people who constantly think they're getting fat or men of normal height who feel short, etc. Somehow, their own self-perception has locked in on a particular feature of their body to such an extent that their image of themselves is distorted, which then often controls many of their attitudes and behaviors. Frequently, in such cases, psychological help is needed to enable these people to reshape their body image along more reality-based lines.

The penis is often involved in the negative self-image of males who feel in some way bad about themselves. When we at UNCIRC, NOCIRC, NORM, and NOHARMM hear from males who report that they grew up wondering what was so wrong with them or their penis that something had to be cut off of them, it is hard to ignore the possibility that such early thoughts have done damage to the individual's self-perception. Again, if we were talking about any other sort of physical mishap or disease which had resulted in the amputation of a body part, the fields of medicine and of psychology would not hesitate to recognize the validity of the problem and to help by whatever restorative and healing skills they had to offer.

In this light, I suggest that many circumcised men who seek foreskin restoration are motivated at an unconscious level by the desire to correct a painful sense of having a mutilated body and the need to 'repair' the resulting self-image.

**2. Regained Power.** A 1991 statistical breakdown of the responses of 301 males who sought restoration information shows that 54.9% of the males who were circumcised under 19 years of age resent their parents for their circumcision. Of those circumcised as infants, 52.7% resent their parents, while 67.5% of those circumcised in childhood, but before 19 years of age, are resentful of their parents (2). Their resentment often results from the belief or feeling that their parents had a choice and could have protected them when they were too young and helpless to protect themselves. As we as a society move very near the point where more infant males will be left intact in America than are circumcised, parents will have an even more difficult time defending their choice to circumcise their sons, particularly to their sons.

It is, in fact, the sense of helplessness which sets up the need to regain power, to feel empowered! This very basic human need is a

critical feature of virtually every ‘victims’ program worldwide. Victims of rape, abused children, abused spouses—female and male, crime victims, etc., typically report a deep sense of helplessness and vulnerability. Such feelings often result in irrational feelings of guilt and self-accusation: ‘What did I do to deserve what I got?’

The therapeutic techniques used in helping such victims frequently include procedures designed to help restore the victim’s sense of self-worth by restoring a sense of regained power. Various methods, procedures, and group situations are used to help the individual to experience once again their own power and self-directedness. I suggest that one of the most important unconscious motives for, and the results of, foreskin restoration is a sense of regained power. That little baby boy is not strapped to that board or being held down any more. He’s up on his own two feet. He’s getting information and acting on his own behalf. And, he’s getting back as much as can possibly be regained of what they took from him. He’s in charge now!

Every victims’ program I know recognizes the health benefits, as well as the milestone effects, of that moment when the victim declares by his or her words or actions: ‘I’m not a victim any more; I’m in charge now!’ Those can be very emotional and profound moments in the therapeutic process. They often signal the arrival at a new plateau in the individual’s journey toward wholeness.

Foreskin restoration is just such a moment for many circumcised men. Even the inquiries UNCIRC receives from men who have just heard about foreskin restoration and that other men feel the same as they do about having been circumcised often echo those ‘victim-no-more’ sentiments. At last, there’s something he can do. And do it, he will!

**3. Anger and Anger Management.** There are a lot of angry people in our society today. Those of us who have been active in the therapeutic field for any length of time know how often we are called upon to help people discover the origins of their anger and ultimately plan a strategy for dealing with it. At the risk of oversimplification, let me say that frustration—that is a sense of hopelessness, helplessness, and defeat—often accounts for the sort of anger that many people feel.

It is always gratifying to see such angry people helped by the comparatively simple means of finding a way to do something about, and within, a situation which has seemed to them hopeless. Becoming effective, taking charge, and feeling empowered go a long way indeed toward reducing frustration levels, which in turn reduces pent-up anger. Angry men, for whom the hopelessness of their circumcised state which they did not choose for themselves is a factor, can be helped a great deal toward anger management and control by *doing something* about a condition about which they had always believed nothing could be done.

### Men’s Voices...

think considerably less of my parents because they could have said ‘no’ to the doctor. My cousin born at almost the same time I was in the same hospital kept his foreskin, and my parents could just as easily given the doctor the same ‘no’ for an answer. The resentment, anger, and grief reaction of a male who was circumcised without his consent is normal, and the parent who said ‘yes’ probably deserves 100% of the wrath because that parent is not an innocent party to the action. Intact foreskins could in many instances add up to intact family relationships when boys grow up.”

L.R., Ohio

“I am 40 years old and was very tightly circumcised at birth in the Air Force hospital in San Antonio, Texas. I have a 3/8" brown scar on my penis and no loose skin at all. I first became aware of my circumcision when the neighbor kids made fun of me when I was about 10 (we were swimming naked). I grew up in the country where not many were circumcised.

Around 1975, I was reading a book where a woman was saying she hated circumcision and how sexy it was to roll back the skin and expose the glans on a man. In 1980, I was married and had two sons. I would not allow them to be mutilated.

I became active in 1986, corresponding with many people about the subject of circumcision. I tell everyone I can, especially women, about how I feel. I believe I was sexually mutilated against my will with no anesthesia for no medical reason. I am very angry and resentful about it.

I am interested in trying to stretch my skin for foreskin restoration. I would very much like to correspond and talk to anyone who has undergone the procedure, or who is currently doing it.”

P.F., Missouri

“I first realized that such a miracle was possible when I read about this procedure in a magazine. I immediately wrote them for information; when it arrived in December 1986, I began in earnest.

(continued)

### Men's Voices...

I was able to begin with stage 2 since I had some skin to work with. I was one of the fortunate ones, although I never really realized I had any extra skin with which to work. Those years of 'self-abuse' finally paid off—the skin was supple enough.

Following the instructions from the BUFF papers, after a shower when the skin was pliable, I applied the 'tape-ring.' It worked and I actually had some skin to pull forward. I find the tape should be long enough to go around the skin twice. If urination is frequent, and the tape comes loose, remove it and re-tape. You will find that every few weeks the skin enters into a dormant or resting stage. Do not give up! Rest it without any tape for a day or so and then resume. (During this time and daily, when the tape is off, manual stretching is very helpful.)

The average time I have worn the tape is 17-18 hours each day; I have found that I cannot wear it at night because nocturnal erections are painful.

I learned about another step from a fellow stretcher who lives in Los Angeles. It involves placing a rubber (neoprene ring) around the skin and then taping it in place. This works well, but it also goes through periods when the dormancy of the skin does not help. Be persistent!

All you have read is true: the sensitivity of the head returns; the color changes; and, in fact, I have become so sensitive that taping is difficult for obvious reasons. Remember, never try to tape if you become erect. Wait until the action subsides.

One last tip: if you apply a bit of softening cream and work it into the skin, it helps to create an elastic property, making the stretching better. Manual stretching using both hands (fingertips) with the cream is good, too—and it enables you to realize just how much you've progressed. Stay with it—it's worth the effort and time to be uncut after a lifetime of being deprived!"

D.B., Buffalo

## Twentieth Century Foreskin Restoration Is Historically Unique

None of the more obvious motives and external pressures which were true in ancient times or under Hitler fits the situation today. Foreskin restoration during the last two decades of the 20th century is truly an historically unique phenomenon. The modern-day circumcised male who desires to restore his foreskin differs in a number of significant ways from those males who have sought to restore their foreskin during other eras. For the first time in history, the quest for foreskin restoration involves males who were circumcised primarily for non-religious reasons. The social institution which their choice for restoration seems to defy is not that of religious authority, but convention and majority opinion within the medical field. Further, the parents of modern-day circumcised males were typically not under a directive from God; therefore, their child believes they *freely* chose to have him circumcised.

**Conformity vs. Nonconformity.** When a Jewish youth sought to disguise his circumcision so that he could participate in the Greek games, he did so to fit in and be unnoticed. His desire was to 'hide in the crowd.' The social acceptance of both nudity and devices to assure foreskin closure allowed him not only to hide his circumcision but to restore his foreskin while appearing to simply observe good manners.

Today, a male in this country who seeks to restore his foreskin must be willing to be a nonconformist. Every aspect of foreskin restoration will cause him to stand out from the crowd. The very foreskin he regains will make him different from the majority of males in his age group. And, certainly any visible devices used for restoration would not go unnoticed in a public shower! Far from causing the circumcised male to fit in, tape, and perhaps other implements worn on the penis, usually drives most males involved in a program of restoration into a private stall rather than use a public urinal.

Even a natural-looking penis can attract attention. A friend of mine, who has spent several thousands of dollars for a surgical reconstruction, related the following incident: After showering at a public gym, he was toweling off at his locker. At some point, he noticed a man nearby looking rather intently at him. My friend said something to break the tension, and the man said to him, "Have you ever considered circumcision?" No doubt one factor which caused the inquiry is the fact that my friend had asked the doctor to fashion him a particularly long, tapering foreskin. It turned out, however, that the gentleman making the inquiry was himself a doctor who couldn't help but notice that here was a man who, according to American medical convention, really *needed* to be circumcised. Why would anyone go through life with such an 'excessive' foreskin and not do something

about it? You can imagine that doctor's surprise when my friend told him that his foreskin—all of it—was man made!

Whether the individual in this country seeks restoration via surgical or nonsurgical procedures, he will be in the minority both as a male involved in foreskin restoration and as a male with a foreskin.

**Social Approval vs. Social Disapproval.** In Chapter 10, we discussed the human need to be 'smiled upon.' Certainly when the ancient Jew accomplished his foreskin restoration, the vast majority of the larger society was ready to welcome him to the benefits and approval of The Great Hellenization Movement. He was, well and truly, one of them now.

The circumcised male today who seeks to restore his foreskin, however, often feels he must keep it a secret. Frequently, when men purchase this book via mail order from UNCIRC, they take pains to request that it be sent in "a plain wrapper" or ask that it be mailed to a friend's house. Often they do not want parents, wife, girl friend, or others to know that they are even looking into the subject. It is considered just too weird in our society for a man to *want* a foreskin.

Before this book was available, UNCIRC provided duplicated information packets regarding foreskin restoration. As does this book, the initial packet contained the recommendation that each man seek the assistance of a doctor with whom to consult throughout his restoration program. It also contained a questionnaire and a letter to the prospective doctor explaining why some men want their foreskin restored and a brief description of the program. There was also an offer to provide the doctor with further information should he desire it. In the years that those packets were distributed, only one doctor ever asked for more information from UNCIRC. To be fair, most men who completed that early questionnaire indicated that they had not consulted, nor did they intend to consult, a doctor. Their reason: the fear that they would be ridiculed and laughed at. The experiences of those men who have sought medical assistance, thus far, confirm the fears of those who have not. The most frequently reported response is ridicule and the suggestion that what the man really needs is psychological help.

The circumcised male who sought help in ancient times was viewed by the medical profession of his day as one who would of course want, 'for the sake of decency,' to cover his glans. Unfortunately, the male who wants his glans re-covered today typically will be seen as emotionally unstable. This means, of course, that the modern-day circumcised male who seeks restoration must be both a nonconformist and able to forego being 'smiled upon.' Indeed, many males who are restoring their foreskin by the time-consuming skin-expansion system write or phone in to note how lonely it feels 'out there' working all alone and in secret.

## Men's Voices...

"At this time, I'm able to pull the skin just past the tip of the glans when I'm not erect. When I am erect, the skin can be pulled forward to cover three-quarters of the glans. Most of the time, I'll wear the skin forward, being held in place with the end of a small rubber. I can't tell you how much more comfortable it is that way rather than with the glans exposed. It feels 'natural,' 'warm,' and protected. I feel whole again as opposed to feeling naked with the glans exposed. Also, you know it's funny, but being able to have my skin in either position, I never realized how sensitive the glans is until I wear the glans covered and it's protected from rubbing against clothing, etc."

B.A., New York City

"How I wish today that the doctor had said something about doing something different. If only he had known or had a group like yours to refer to. I feel I was raped in the operating room, and I want back what was mine. I know foreskin will not make me a better man—or richer or more good looking—but maybe it will give me back something that I have missed for a long time. Thank you for your support. I never knew that anyone cared about his. It makes me feel better just to know there are people I can talk to and that there is hope of getting back what I lost as a kid."

Circumcised at 15 for "tight" foreskin  
P.B., South Carolina

"As a child, when I noticed that a neighbor boy was different, I thought that just like there are different breeds of dogs, there might be different breeds of humans—some with extra skin on their penis, others without. It never occurred to me that he was intact and I had been mutilated. I guess I really didn't understand what had happened to me until I was in the military in the late 1960s.

Recovering my foreskin has been a desire of mine since then. Now that I know that a foreskin will not only make me look more natural but will also improve sex, I am determined to get what I have wanted for so long. I have waited years to start this process. If it takes years to finish, so be it."

N.R., Texas

### Men's Voices...

"I am strongly connected to your experience of uncircumcision. I did not realize how strongly until I experienced my body relax when I successfully coaxed what skin I had left to cover the head of my penis and stay there all day taped as you describe in Stage II. I wouldn't have believed this feeling would or could happen. Over 40 years of unaware tension was released, and it continues to feel great."

A.K., New Hampshire

"It's a tremendous relief to learn that after a lifetime of fearing to mention the subject, I am not alone with the emotional and physical damage I received from the bizarre and unspeakable American practice of neonatal circumcision.

I showed your book to my wife, who said, 'I didn't know this meant so much to you.' Once or twice over our married life I had alluded to physical problems from my tight cut and mentioned that I felt like 'damaged goods' because of my circumcision. She was very reassuring but obviously could do nothing about it. When I read about a possible means of restoration without further surgery, I knew I had to try it. Like so many of your 'customers,' I almost cry when I think that I could have tried this 20 years ago had I known about it.

P.S., My son, who will be four in December, is a healthy, natural man."

M.N., Maine

**Lack of External Incentives.** The early Jew who restored his foreskin would be rewarded not just with smiles but with real payoffs. He could at times avoid military service and taxation if he possessed a foreskin and was properly 'Hellenized.' These factors were no doubt powerful incentives. No such benefits accrue to the circumcised male today to encourage him to restore his foreskin. To the contrary, the cost of surgical reconstruction and the 'price in patience' exacted by nonsurgical procedures mean that today's circumcised male will pay a real price for his determination to regain his foreskin.

**Possible Psychological Motives of Ancient Jews.** In comparing foreskin restoration in ancient times and in the modern-day social climate, it can seem that I am suggesting that Jews in those early times *only* restored their foreskin for social, political, and economic gains. While it is true that these motives are historically documentable, I have every reason to believe, as a psychologist, that surely at least some Jews who sought restoration in that day were also motivated by the same less conscious, psychological needs as men today are motivated. No doubt they used the more obvious benefits of that era as rational justifications just as men today state the more obvious reasons for restoring their foreskin. It seems likely, however, that physical amputation, and its attendant sense of loss, is probably just about the same human event whether it occurred in 100 B.C. or in 1952 A.D.

**Hostility.** We've already looked at the tendency of some doctors to get angry when a circumcised male complains to them about being circumcised. We particularly noted in Chapter 10 that such a complaint may well cause cognitive dissonance or strong defensive reactions within the doctor.

This tendency to anger, however, is clearly not limited to doctors. I have noted time and again that other circumcised males or parents of circumcised sons are made truly uncomfortable by the mere fact that a circumcised male doesn't like having been circumcised and is doing something about it. I cannot begin to relate the extent of the hostility and agitation expressed by some of these individuals as they try to justify their own circumcised state or the decision they made for their son. Somehow, the very fact that a circumcised male is working to regain his foreskin throws up all sorts of challenges to many people's defenses. The male who 'rattles their cage' can expect to be lashed out at.

Before we consider the current developments in both tissue expansion and the various options for foreskin restoration, I would like to share with you, as much as is known to me, the historical development of the modern-day foreskin restoration movement and of both surgical and nonsurgical procedures.



# 12

## The Modern Foreskin Restoration Movement

*“There have been some very noble people involved, and these are the unsung heroes of the movement. They donated lots of time to helping people, never asking anything in return. There are no words adequate to describe their selflessness, and the valuable emotional and practical support they offered.”*

### Another unsung hero

Prior to this modern-day movement, with rare exception, all foreskin restorations were done under some sort of social or political duress. Then, in the early 1960s, Dr. Jack Penn published the results of a surgical procedure he had done for a 35-year-old man who “was concerned about the fact that he had a circumcised penis and *did not like it*” (1). (Emphasis JB) Although it would be several more years before other men who were dissatisfied with their circumcised state would hound doctors in this country for help, the die was cast. Foreskin restoration, freely chosen by circumcised men who ‘do not like it,’ was here to stay.

It has been both an exciting and frustrating project to set about documenting the modern foreskin restoration movement: exciting because it would seem that this is the first time a comprehensive documentation of its brief history and development has been attempted, frustrating because so many of the men who participated in its development just a few short years ago are already lost in obscurity—some by their own choice. Actually, the entire history of the movement spans just over 30 years (Figure 12-1).

### The Unknown Independents

Before tracing what is known of the early pioneer efforts, both by doctors and by those individuals who sought to help others find the information and help they needed, it seems appropriate to at least acknowledge the existence of unidentified individuals who worked alone to restore their foreskin. No one will ever know how many men through the years have worked in private and without any knowledge that others were doing the same thing or wanted to accomplish the same goal. The evidence for the existence of such individuals comes from the fact that each one of us who currently provides information

### Men’s Voices...

“I am 29 years old, 6’ 2”, about 170 pounds, and healthy. I have always wanted to be uncut. I think babies should be left in their natural, foreskin intact, state.

I have been stretching my skin for as long as I can remember. I am circumcised but can, when my penis is soft, roll my skin all the way over the head. I have ‘rolled’ it like this and put on a tight jock strap or folded my penis so that it would remain ‘encased’ or covered. However, when I take away the restraint, my penis slowly rolls out to its circumcised look.

I believe if I could keep it stretched, the skin might stay that way if done for a long enough period. I worry about, if it were bound in some way, what about erections, going into the shower, urination, and leaking after urination. Please contact me. I look forward to hearing from you.”

C.R., Buffalo

“For several years, I had found bits of information about the taping method and the ability to regain that which had been taken away from me at birth. I have done some stretching and have acquired a decent amount of skin on the underside of the shaft. When flaccid, a very small amount of skin

*(continued)*

**Men's Voices...**

covers the rim of my glans. I've tried taping several times, but can't seem to get enough skin to get a good grip. It seems to hold for only a couple hours.

Therefore, I believe I could really benefit from your book—besides, I'm afraid of injuring myself if I'm not careful.

Thank you very much for your time and help in this matter. I will be looking forward to hearing from you soon."

G.B., Vermont

"When I was a child, my penis was really sensitive on the head. The foreskin was gone, and so the head rubbed against my clothes all the time, making it sore. This really hurt during puberty, and anything that touched it caused an embarrassing erection so I didn't date and avoided girls. I masturbated a lot to keep from getting erections. Still to this day, I get an erection when pressure is put against my penis, but several years ago (about 10) I started stretching my penis on my own. The skin is pliable, and covers part of the head when flaccid. My erections don't happen as often, and the head is more sensitive once again, but is protected by what foreskin I have gained."

A.P., Dallas

"I was born in 1940 in an Army hospital. A circumcision was performed approximately six hours after birth.

I cannot pinpoint the exact time when the realization came that I was damaged—incomplete. My early recollection around the age of four years was that something was missing—and with it an intense feeling of loss coupled with a complete lack of understanding as to what had happened. The overwhelming feeling was not that I was simply different, but that something was terribly wrong. Was this a punishment? If other boys had foreskins why didn't I have mine? They could appear circumcised by simply retracting their foreskins, but there was no way that I could gather enough skin to cover the head of my penis to look uncircumcised. My

*(continued)*

Period	Event
<b>Early 60s</b>	First modern surgical foreskin restoration in Johannesburg, South Africa.
<b>Mid-70s</b>	Direct inquiries to various doctors in this country regarding surgical foreskin reconstruction.
<b>Late 70s</b>	Early surgical techniques pioneered.
<b>Early 80s</b>	Nonsurgical techniques experimented with, loosely documented, and information circulated on a small scale.
<b>Mid-80s</b>	Both surgical and nonsurgical methods improved and further documented.
<b>Late 80s</b>	Surgical foreskin-expansion methods and devices pioneered.
<b>Early 90s</b>	Nonsurgical Skin-Expansion System revised, codified, and made available on a wider basis. NORM founded in San Francisco Bay Area to support men involved in foreskin restoration. First edition of this book opened the topic of foreskin restoration to the general public. NOHARMM organized to give circumcised men a voice. Surgical skin-expansion devices redesigned and improved. Surgical procedures refined and simplified.

Figure 12-1 Overview of the major developments in the modern foreskin restoration movement

on foreskin restoration has met, and continues to meet, such men. I am always amazed when I meet an individual who says, 'I started restoring (or I restored) my foreskin years ago,' or 'I didn't know anyone else was doing it until I recently heard about you people,' and so on.

I met one such man in 1989 who told me that he had begun about 30 years earlier to use Band-Aids to tape his shaft skin forward over his glans. By the time we met, his glans had been fully covered for years. He noted that he had not been at all sure it would work when he started and that he certainly had no idea anyone else would ever do it!

Another individual related that he had gotten the idea from pictures of indigenous peoples with distended earlobes and lips in THE NATIONAL GEOGRAPHIC MAGAZINE. After seeing these pictures, he embarked on a study in the library to discover what was then known about skin and tissue expansion. He then set out upon a regular course of 'foreskin development.' His system was simply to pull on his shaft skin in a regular pattern at two-week intervals. That was 11 years before I met him. At which time, his glans was completely covered, and the regained foreskin had remained in place over the glans when his penis was flaccid for at least three or four years.

## The Earliest Record of Modern-Day Surgical Foreskin Reconstruction

As a matter of historical interest, the earliest known surgical reconstruction in ‘modern times’ was performed in Canada in late 1897. Although reported in 1898, in a medical journal published in Canadian French, the article describing the procedure has only recently come to light (2). The 38-year-old patient had been circumcised two years earlier and could not adjust to his “completely bare” glans. Fortunately, the individual had ample shaft skin remaining such that it could be pulled forward to completely cover the glans. The procedure carried out by Dr. O.F. Mercier consisted of 1) constructing a “new frenulum” and 2) narrowing the aperture [orifice] of the new foreskin by vertically suturing a single transverse, dorsal incision. Relative to men today who have achieved complete coverage of the glans by the skin-expansion system, Dr. Mercier’s procedure would be more like a surgical ‘touch up’ (see Chapter 19).

In 1963, Dr. Jack Penn of Johannesburg, South Africa, published his now rather well-known article, “Penile Reform,” in the *BRITISH JOURNAL OF PLASTIC SURGERY*. While Dr. Penn may not have been the first surgeon in modern times to perform a foreskin reconstruction, his is the first known reconstruction in the era of *routine* medical circumcision, and his is certainly the first procedure which had an influence on the modern-day restoration movement. His entire article consists of three pictures showing the penis before, during, and after the procedure and the following two paragraphs of text:

Mr. E, aged 35 years, was concerned about the fact that he had a circumcised penis and did not like it. He wished to have his prepuce replaced. He agreed to having psychological investigation. The reports submitted indicated a marked psychological disturbance due to his circumcision and that he was normal in every other way. Surgical repair was then offered.

The operation consisted of a ‘degloving’ of the skin of the penis by means of a circumferential incision at the base of the penis with the skin pulled forward to cover the glans. A free graft was then applied to cover the entire new area from the tip of the prepuce to the base of the penis. The result was satisfactory physically and the patient was completely rehabilitated psychologically (3).

As brief as this documentation is, I am assured by one individual who eventually sought and underwent surgical reconstruction that this article spurred him on to seek medical help in this country.

## Grassroots Movement: Early Networking

Spurred on by Dr. Penn’s article and their own determination, a few very persistent men sought and eventually found surgical help to restore their foreskin. As word spread in the late 70s and early 80s that there were at least some doctors willing to help circumcised men

## Men’s Voices...

circumcision was exceedingly tight. Some three-quarters of the shaft skin had been amputated. I was literally ‘scalped.’ In addition, I had curious ‘bumps’ along the scar line which were painful to the touch and the glans was often painfully abraded even to the point of bleeding, by the rubbing of underwear. Also, there were ‘holes’ in several places around the scar lines with one particularly large hole created by an unhealed flap of skin where the frenum had been severed about 1/4 inch from the glans. Thirty years later, I learned that the ‘bumps’ were granulomas just under the skin surface involved in nerve damage and that the flaps were left over from sutures and uneven healing.

One particular vivid memory as a first grader is an afternoon spent trying to pull enough skin over the glans to create a foreskin and keep it in place with a band-aid. Using six-year-old logic, I thought that this would allow the skin to ‘grow out.’ That afternoon was a study in frustration, pain, panic and inadequacy. Even so, I remember trying other ways during the next few years—adhesive tape, clay, cardboard—anything I could think of which might force the stump of skin to cover the head.

By the time I was in high school, my masculine identity had been established as one of every other male being better than I was. If he was uncircumcised, he was complete and therefore better. If he was circumcised, he was also better than me because (apparently) he was not troubled by it as I was.

When I was in high school I began some preliminary research into circumcision—the medical reasons which were given at the time and the religious issue. Although there was precious little written dissent from medical authorities, I began to have more and more difficulty with the basic logic of such surgery. Over the years as isolated bits of research would debunk one more of the ‘reasons,’ I became more and more angry and dissatisfied both with the fact of my circumcision and especially the manner of it—a real ‘hack job.’ I also began

(continued)

## Men's Voices...

developing associated problems with overweight, depression, poor school adjustment, and peer group social problems. The ability to focus on daily living was becoming increasingly difficult. And the worst of it was that there was not one person, adult or peer, who I was able to talk to! A couple of initial attempts had been met with either complete amusement or total embarrassment. One learns very quickly to keep controversial problems a secret. Even so, I was unwilling to accept my circumcised state, especially considering the poor results and the continuing pain and abrasions.

By the time I entered college I had researched enough to know that many peoples of the world were never circumcised and the dire predictions of American physicians toward the uncircumcised seemed totally unrealistic. I concluded that circumcision was a ritual peculiar to only some people, and that in terms of medical practice, an amputation had been performed for no reason other than the obstetrician's faith in a medical practice currently in vogue. (How any rational person can honestly believe that the cutting off of a flap of skin will save him from disease or make him religious is still beyond me!)

In the more cosmopolitan atmosphere of college, I was able to share my thoughts with some peers without the devastating reactions of the earlier attempts. This provided a safety valve of sorts while I continued collecting data with the added facet of medical reports concerning surgical repairs. Very little was available, but what there was convinced me that there should be some way of, if not reconstructing a foreskin, at least alleviating my pain problems. I consulted a physician who could not conceive of anyone wanting a foreskin. He did not comprehend the pain I was having, but he did surgically remove, in an office procedure under a local anesthetic, the largest (and unsightliest) granuloma on the dorsal scar. The result was a little less pain in one spot and the beginning of an earnest search to find a doctor who could and would undertake to repair and reconstruct. A number of initial inquiries

(continued)

regain their foreskin, various individuals and small groups began to provide information, and even the hospitality of their home, to other men seeking help. I suppose it can be said that a fledgling 'foreskin restoration movement' began to take shape. Two pioneering efforts at networking intended to connect circumcised males with available help warrant recognition.

**John Strand, San Antonio, TX.** In a very touching and revealing interview, John Strand recounts his quest for help from the medical community. If anyone doubts the rebukes and rebuffs that a circumcised male in America can be subjected to when he seeks medical help, just read that account in the adjoining column. The reactions John received are all the more inexplicable when one considers that he was suffering from very painful physical consequences of a poorly done circumcision (4).

In 1977, John Strand became the first foreskin reconstruction patient of Dr. Donald M. Greer, a pioneer in surgical techniques. John is undoubtedly responsible for Dr. Greer's venture into this field. John's other significant contributions to the development of a foreskin restoration movement were his willingness to talk to other circumcised men, to encourage them in their quest for help, and to offer them the hospitality of his home. For as long as Dr. Greer practiced in Texas, John Strand assisted most of the doctor's reconstruction patients with hospitality in his home, encouragement and support, and post-operative care. It is not surprising, then, that John's name comes up over and over again when one talks to those who have been the recipients of his care and concern.

**Pioneers of the Nonsurgical Restoration Method.** Once again, the impetus came from circumcised men looking for help. In the late 70s and early 80s, a group of men began to correspond with each other for the purpose of sharing information and offering mutual encouragement. While some of these men were in touch with John Strand and were familiar with Dr. Greer's procedure, they also investigated and shared information about other surgical techniques and surgeons which came to their attention. An early list compiled in late 1981 gives the names of five doctors across the country who were known to be willing to work with men seeking reconstruction, Dr. Greer being one of them. The experience of each doctor in reconstructive surgeries is also given: "Two restorations, both for loss of skin—one from burn trauma and one from cancer. Jack Penn method," etc. That list notes that, as of 1981, the total known cases of foreskin restoration in the United States was probably less than 50.

Among the doctors on that 1981 list is a Dr. J. Sheldon Artz of Ohio. This doctor is reported to have worked with *one* case in which he implanted a platinum ring in the 'foreskin' after the skin had been

pulled forward in front of the glans. This procedure resulted in 'created phimosis.' The proposed procedure called for leaving the ring in place until the skin had stretched and lengthened and then removing the ring. It was hoped that the newly created or expanded foreskin would then remain in place and cover the glans.

Two disappointing results with the platinum-ring procedure were later documented. First, the skin did not stretch enough to assure coverage once the ring was removed. Second, the ring tended to cause the formation of fibrous tissue around the ring, thus, leaving a 'raised,' visible ring under the skin even after the platinum ring was removed.

It was while pondering the merits and shortcomings of the implanted-ring technique that the idea for what was to become the BUFF Nonsurgical Foreskin Restoration Method was born. An unsung hero, who chooses to remain anonymous, wondered, "If holding the foreskin forward over the glans caused new skin to be produced, why not accomplish the same effect with tape and avoid surgery altogether?" That was 1982, and the rest, as they say, is history!

**BUFF.** Brothers United for Future Foreskins was launched in August, 1982. The original 'stretching' procedure using tape, the circulation of information, and the ongoing development of additions to and improvements in the techniques are the combined work of many dedicated men—and at least a wife or two. Actually, BUFF has become rather well known among men seeking restoration information. The acronym, BUFF, is listed in *THE ENCYCLOPEDIA OF ASSOCIATIONS*, and, as of this writing, the organization has responded to many hundreds of inquiries from its headquarters in southwestern United States. These inquiries come from men in various parts of the country, virtually every other English-speaking nation, and several other nations as well (5).

During the years since 1982, a number of satellite BUFF centers have come and gone, and no accurate numerical estimate of their impact is possible, although it is known that hundreds of men made inquiries during the tenure of some centers. No one could have foreseen, even a few years ago, the impact that nonsurgical restoration would have on the issue of male circumcision worldwide. Many states, as well as a growing number of nations abroad, now have publications or groups or centers which offer support to circumcised men and apprise them of the nonsurgical option for foreskin restoration. Whatever else may develop in the years to come to help circumcised men recover from the wound of their circumcision, a great debt of gratitude will always be due that small, grassroots network of men who decided to be Brothers United for Future Foreskins. I wonder if any of them ever imagined just how far into the future their determination and their commitment to an idea and to each other would reach?

### Men's Voices...

were met with such ridicule that it literally threw me back for long recovery periods until I would get up the courage to try again with the almost sure knowledge that I would be subjected to more ridicule. I tried the family doctor and while not ridiculed directly was given a pat on the head and an immediate appointment with a psychiatrist. This particular psychiatrist was such a complete fiasco and so filled with hostility that it took me several years to revive the courage to approach anyone again. I wrote letters to some plastic surgeons. When there was a reply it was judgmental, curt, and unemotional: 'There is no reason to attempt this, and no way to do it!' I tried a local plastic surgeon who had the cruelest diagnosis of all: 'Yes,' he said, 'it is possible to create a tube of skin surgically from a graft, but under no circumstances would I do it!' That rebuff took me another several years to reconcile. I wrote to Ann Landers and got a gentle admonishment to try a psychiatrist as quickly as possible. The inequity of the whole thing really depressed me. Here I found it acceptable, even encouraged, for any man to walk in off the street to any doctor and have a circumcision performed and be considered to have made an appropriate and laudable choice. On the other hand, let someone come along who wishes to be uncircumcised and he is immediately psychologically suspect! (One head of a psychiatric clinic once told me that all men who had a wish to be uncircumcised were paranoid, schizophrenic personalities!)

Some years later I tried the family doctor again and managed to convince him that I was in constant pain and irritation, and serious about repair. This time he made a medical referral which quickly led to a series of doctors. I finally met Dr. Don Greer of the University of Texas Medical School Plastic Surgery Department. He was the first to spend any amount of nonjudgmental time and give any positive confirmation to the availability of surgical repair and reconstruction techniques. Although the idea of creating a foreskin was unique to him, he

*(continued)*

## Men's Voices...

agreed to research medical and surgical angles for six months and I was to undergo some therapy as a pre-surgical requirement. If, in six months he found there was adequate plastic surgical technique available to produce the desired results, and if I still wanted to gamble, then we would go ahead.

The empathy and perception of this man to be able to see through all the years of anger, pain, frustration and rejection was no less than a miracle.

The initial surgical procedure was completed in May 1977. A double pedicle graft was raised from the lower scrotal area approximately 6" by 2" and imbedded into a complete circular incision over the original circumcision site. The residual membranes were turned over the glans creating a foreskin with about 4/5 coverage of the glans. The hospital stay was five days and a catheter was in place for some 12 days. Post-operative swelling was considerable, but the complete graft 'took' and in a second and third procedure, the two connective pedicles were cut free and the newly constructed foreskin was utilizing its own internally generated blood supply. Two subsequent operations a year later removed scar tissue and repositioned some of the pedicle closure areas. There is a marked reduction in pain due to the excision of the granulomas. There is still extreme sensitivity of the glans to pain, however, the coverage of the glans renders it much less subject to the daily stresses of underwear abrasion. A vein system has grown across the surgical line and there is some return of gross feeling in the graft, although by no means is it the equivalent of a natural foreskin.

While I can understand the motive of the obstetrician in performing circumcisions according to the practices of his time, I can never forgive him the fact that he botched the procedure miserably. I have been subjected to an amputation for no good reason, without my consent (or my parents—they were not asked) and to which I would never have agreed had I been consulted.

(continued)

## Early Breakthroughs in Surgical Technology

While nonsurgical skin-expansion procedures were being experimented with and information made available through a word-of-mouth network, several significant contributions were made in the advancement of surgical foreskin reconstruction techniques.

**Dr. Neil R. Feins, Boston, MA.** Dr. Feins' 1981 article, "A New Incision for Penile Surgery," appeared in the JOURNAL OF PEDIATRIC SURGERY (6). The intent of the article was to report on an incision technique which allowed the necessary surgery for seven different penile deformities and diseases to be performed with greater efficiency and with less risks to the penis itself. In the brief conclusion, Dr. Feins makes two statements relevant to foreskin reconstruction: First, "The incision may find uses for numerous other surgical problems, including urethral stones, Peyronie's disease, and even creation of a prepuce in previously circumcised individuals." Second, "Maximal mobilization of the penile skin allows for correction of lack of ventral skin [a common condition among circumcised males]." This surgical technique will be discussed again in Chapter 21 dealing with some newer methods which propose to combine skin-expansion techniques with surgical methodology.

**Dr. Donald M. Greer, Jr., et al., San Antonio, TX.** "A Technique for Foreskin Reconstruction and Some Preliminary Results," was published in 1982 in THE JOURNAL OF SEX RESEARCH (7). This article reports, for the first time since Dr. Jack Penn's pioneering document, a technique specifically devised to help circumcised males *reverse* their circumcision as opposed to repair for other more recognized penile damage. The surgical technique first performed in 1977 and later improved by Dr. Greer and his associates utilizes scrotal graft and implantation. The procedure will be discussed in detail in Chapter 20. I would like to note here, however, that Dr. Greer estimates that he performed some 35 procedures while he was working in this field. That number may well qualify him as the individual who has, to date, performed more circumcision reversals than any other modern-day surgeon who has worked in this field.

**Dr. Willard E. Goodwin, Los Angeles, CA.** Although Dr. Goodwin's name is to be found in correspondence regarding foreskin restoration as early as 1982, he did not publish his article, "Uncircumcision: A Technique for Plastic Reconstruction of a Prepuce After Circumcision," until 1990. To be sure, he had suggested a version of the same technique for penile repair in articles dated 1950 and 1952 (8). As in the case of Dr. Greer, Dr. Goodwin's technique utilizes scrotal graft and implantation (9). Again, this technique will be discussed in greater detail in Chapter 20.

## The Impact of the Intact Baby Movement

Marilyn Milos, founder of NOCIRC, has said, “After I saw my first infant circumcision, I began my work to stop the screams of babies, and suddenly men began to scream.” Similar statements could be made by every individual who has been involved in the effort to end male circumcision in this country. While a detailed history of this movement is beyond the scope of this book, the impact of such organizations and their efforts to raise public awareness cannot be ignored. Virtually every time there is a public statement made regarding infant circumcision, whether in newspapers or magazines or on radio or TV, circumcised men respond with inquiries to know if anything can be done to help them. Such inquiries are another reason that there can be no accurate estimation as to how many circumcised men through the years have received the BUFF restoration information. Virtually every group organized to fight routine infant circumcision has regularly provided restoration information in some form to adult males who make inquiries.

Actually, while the restoration movement for many years sought to maintain a rather low-key profile in order not to embarrass or call attention to men already in pain, the anti-routine-infant-circumcision organizations have sought just the opposite. In order to be effective, such activist groups must attract attention and make their voice heard. It has, therefore, often been these groups which have first gotten the attention of the circumcised male who is unhappy and angry about his circumcision. His resulting inquiry to such a group is just one more link in the ever-growing information network.

Before leaving the subject of the contributions made by the Intact Baby Movement, I would like to recognize those groups known to me. The 1985 edition of THE ENCYCLOPEDIA OF ASSOCIATIONS listed the following dates and officers for four of the early organizations (10):

- 1973 Non-Circumcision Educational Foundation, NY, James E. Peron, Executive Director.
- 1973 Non-Circumcision Information Center, West Roxbury, MA, Roger Saquet.
- 1976 INTACT Educational Foundation, Wilbraham, MA, Jeffrey R. Wood, Founder/President.
- 1980 Remain Intact Organization, Rev. Russell Zangger, Founder/President.

Throughout the 80s and early 90s, other groups were founded:

- 1985 NOCIRC (National Organization of Circumcision Information Resource Centers), Marilyn F. Milos, Founder. This organization grew out of an earlier concern for the lack of ‘Informed Consent.’

## Men’s Voices...

As of this writing, five restoration surgeries have been performed here. Three more are scheduled for the coming year. The number of surgical steps has been reduced as has the time between the steps.

Research has revealed that these procedures have been performed throughout history. In the United States currently there are a number of people who have had such repairs done.

Intensive psychiatric testing and evaluation have shown that there are no psychiatric reasons for withholding this type of surgery other than the physical and emotional inability to withstand surgical stress in itself.

People should realize that just because there is a repair procedure, one should not go ahead and cut a baby because it can be fixed later. It is far from easy and while the results are entirely satisfactory, it must be emphasized that this is not a natural foreskin and never will be. The sensitivity and some of the mechanical subtleties of the natural foreskin are lost forever.”

John Strand, San Antonio, Texas  
from *Circumcision: The Painful Dilemma*  
by Rosemary Romberg

- 1985 Peaceful Beginnings, Rosemary Romberg, Founder. This organization was begun in Washington state but has been headquartered in Alaska since 1988.
- 1986 Gulf Coast Infant Circumcision Information Center, John A. Erickson, Founder. John, as an individual, has been particularly active in letter writing and in compiling and editing a number of publications designed to inform and to raise public awareness.
- 1991 Circumcision Resource Center, Ronald F. Goldman, Founder. The organization provides both information relative to infant circumcision and a support group for circumcised men.
- 1992 NOHARMM (National Organization to Halt the Abuse and Routine Mutilation of Males), Tim Hammond, Founder. This organization orchestrates public demonstrations and publishes a range of resources which provides information, guidance, and matériel to men who want to speak out against the outrage of routine male circumcision.

### Recent Books from the Perspective of the Intact Baby Movement

During the years from 1980 to 1992, five significant books have been published, often as an adjunct to the various groups in the Intact Baby Movement:

- 1980 CIRCUMCISION: AN AMERICAN HEALTH FALLACY by Edward Wallerstein (11). It would be difficult to find a more scholarly treatment of any subject than this book!
- 1985 CIRCUMCISION: THE PAINFUL DILEMMA by Rosemary Romberg (12). This was the first book I found after I knew there were others who felt as I did. It has over 450 pages; I read it in a day or so!
- 1985 CIRCUMCISION: WHAT EVERY PARENT SHOULD KNOW by Anne Briggs (13). A fine, concise, easy-to-read book. Every expectant parent should read it.
- 1990 CIRCUMCISION: WHAT IT DOES by Billy Ray Boyd (14). This book endeavors to survey the effects of circumcision and reflects the activist views of its author.
- 1992 SAY NO TO CIRCUMCISION! by Dr. Thomas J. Ritter (15). This is the only book listed here written by a medical doctor. It explains to parents why they should leave their son intact.

### Men's Self-Help and Activist Organizations

While it is true that the early pioneers in the foreskin restoration movement sought to maintain a low profile, recent developments now make such a stance impossible. Media coverage via newspapers, magazines, radio, and TV has become a real factor. It seems the very fact that circumcised men are restoring their foreskin has become a current topic of interest. Furthermore, an increasing number of men are discovering that it is not so difficult to stand up and tell the public and the medical profession that they do not like what was done to them. Obviously, no individual ever has to come forward and be identified. But, for those who feel that they would like to make a statement, the opportunities have never been better.

As noted earlier, groups and centers which offer circumcised men support and information are forming worldwide; therefore, a comprehensive survey of their various structures, aims, and activities is not possible here. A brief discussion, however, of three West Coast organizations, with which I am affiliated, will serve to illustrate current trends:

**UNCIRC.** My own involvement with the BUFF organization began in 1987 shortly after I saw a *Donahue* show which featured Marilyn Milos, Richard Steiner, and Dr. Dean Edell. Up to that point, I did not know that anyone else felt as I did about being circumcised, and I certainly did not know there was any remedy! My first contribution, in 1989, was to devise an innovation in terms of a modified taping procedure for men with particularly sensitive skin. After I had been providing a description of that taping method to men who inquired via NOCIRC, it was suggested that I distribute the original BUFF material as well. The decision to do so resulted in my involvement in a complete revision of most of the BUFF publications current at that time. That revised material was distributed from the California center from early 1990 to the end of 1992.

When plans developed in the spring of 1991 for the writing of this book, it seemed wise to have a name for the California center. The first name adopted was R.E.N.U. (Resource Exchange for Nonsurgical Uncircumcision). That title lasted for a few months until it became apparent, as work on this book continued, that there was a need for an information exchange and national medical registry



which would not be limited to information on nonsurgical methods only. In August of 1991, the name was changed to UNCIRC (UNCircumcising Information and Resources Center). The aim of this center is to provide whatever current information is available on the subject for foreskin restoration—both nonsurgical and surgical methods. Initially, that meant distributing the duplicated information packets and/or a list of doctors who were either willing to work with circumcised men seeking to restore their own foreskin or who worked in the field of surgical reconstruction. It also meant an ever-increasing amount of time on the telephone talking with men who very often “have never talked to anyone about this before.”

When the first edition of this book became available (March, 1992), the day-to-day activity at UNCIRC changed somewhat, since general information as well as answers to many of the typical questions were now “in the book.” This fact alone has given more time for writing and speaking and for responding to the media attention generated both by the book and by the ever-higher profile of NOCIRC, UNCIRC, NORM, NOHARMM, and the other information centers and support groups worldwide.

The range of responses to this book has been interesting and indeed surprising at times. For one thing, most of the mainline, chain bookstores have refused to stock it. That seems very strange and a little shocking when you consider the wide range of subject matter that can be found on their shelves. Although bookstore sales finally outnumbered mail orders during the first half of 1994, at present, the book can only be purchased by ‘special order’ through most chain stores. As a result, UNCIRC will continue to be the mail order supplier of the book, at least until more bookstores take notice.

At the other extreme, the book has now been reviewed by five major medical journals: THE JOURNAL OF THE AMERICAN MEDICAL ASSOCIATION (16), PLASTIC AND RECONSTRUCTIVE SURGERY (17), JOURNAL OF NURSE-MIDWIFERY (18), BRITISH JOURNAL OF UROLOGY (19), and BRITISH MEDICAL JOURNAL (20). This is very unexpected attention for a book by a nonmedical writer. There have also been extremely generous reviews in various magazines and in a number of publications within the men’s movement. Added to this, the press coverage in major newspapers both at home and abroad has at times been beyond all

expectations, especially in England and Australia. No doubt the recent establishing of restoration information centers—also known as ‘*enthusiastic-motivated-individuals-who-naively-offer-their-help*’—in both of these countries has been a direct result of the very positive press coverage.

The vision and ideas for the services which centers such as UNCIRC might provide look far beyond the typical limited resources presently available. But, we must look ahead. The sad fact is that every year until well into the 21st century there will be an *increased* number of sexually active, circumcised males in this country. Current trends suggest that these males will increasingly choose to reverse the circumcision they did not choose for themselves. As that happens, help must be more readily available to them than it has been for their fathers and grandfathers before them. We will consider some of the future needs and vision in Chapter 22.

**NORM.** The National Organization of Restoring Men originated in the San Francisco Bay Area, and there are now a dozen or more groups across this country and at least four abroad. Founded in 1990 by R. Wayne Griffiths and Tim Sally, the purpose of these groups is to provide an arena in which men who are interested in foreskin restoration or are restoring their foreskin by the slow and often tedious skin-expansion system can encourage each other. The agenda varies from meeting to meeting: guest speakers, a doctor willing to work with these men, a circumcised male who has had a surgical reconstruction procedure, video-taped sessions of important medical meetings, etc. In addition, men are encouraged to share their successes and frustrations and, particularly, to exchange information relative to techniques and discoveries. The value of the encouragement and help which men can offer each other is evidenced by the almost daily requests for information regarding the availability of regional support groups. In Chapter 22, we will discuss further the value of such mutual support groups and the simple goals and purposes for which NORM strives.

**NOHARMM.** Inspired by the “Victims Speak” concept introduced earlier by Billy Ray Boyd (21), NOHARMM grew out of a desire on the part of Tim Hammond, and other members of the San Francisco NORM group, to help raise public awareness of the fact that routine male circumcision constitutes male genital

mutilation (MGM). The intent is to channel and focus men's anger and frustration about what was done to them so that the energy generated by these very powerful emotions is translated into positive action. The mission is that of advocacy for the baby boys still being mutilated on a daily basis. NOHARMM believes that all baby 'men-in-the-making' have an inalienable right to a whole body. Thus, the work of this organization focuses on 1) the human rights issue involved in the routine infant circumcision debate and 2) the harm done to men by circumcision. The primary strategy used to capture the public's attention is a variety of organized demonstrations.

The 'official' response to the various NOHARMM events differs from situation to situation. For example, when NOHARMM rallied on the steps of the California Medical Association in San Francisco (July, 1993), Dr. Edgar Schoen of the American Academy of Pediatrics Task Force Committee on Circumcision watched from a second-story window with several officials and workers amid obvious disdain and mirth. And, when a three-person NOHARMM delegation sought admittance to either speak with a representative of the association or make a future appointment to do so, they were barred at the doors by a cordon of armed city police, some 12-15 strong! The reception, in this case, may well be related to the fact that the California Medical Association, at the persistent urging of Dr. Aaron Fink, is the only medical association in the world to have adopted a resolution declaring routine infant male circumcision an effective public health measure.

On the other hand, when NOHARMM demonstrated in front of the Physicians' Committee for Responsible Medicine, in Washington, D.C., (May, 1994), its director came out to the demonstration, sought out Tim Hammond, and invited a representation to meet with him in his office. Whether or not one can always trust the motive behind such public relations strategies, the contrast between these two receptions is clearly evident.

The 'unofficial' responses are mixed as well. As a part of its stance, NOHARMM supports the current fight against female genital mutilation (FGM) and attempts to draw attention to the parallels between FGM and MGM. To that end, a group of us from NOHARMM attended the

West Coast premiere of Alice Walker's *WARRIOR MARKS*, in San Francisco (November, 1993). While some of us attended the reception for Ms. Walker before the film, others passed out leaflets to the crowd waiting to enter the theater. When men attempted to speak during the discussion session near the close of the evening, they were booed, hissed, and yelled into silence by the largely female audience. A few months later (March, 1994), a group from NOHARMM attended a screening of Soraya Mire's *FIRE EYES*, in Berkeley, California. On that occasion, the men were both listened to and welcomed as participants in the dialogue. When you decide to go public for the cause, you need to understand that, at least for that occasion, you're making a "for better for worse" commitment.

In addition to coordinating various demonstrations nationwide, NOHARMM has, to date, produced two major publications: *MALE CIRCUMCISION IN AMERICA* and *AWAKENINGS*. The former is a 'primer' which contains an evolving collection of materials to inform and direct the energies of men who wish to speak out on behalf of newborns. The latter contains the results of the first known national survey, intended as a preliminary study, to explore the harmful effects—physical and psychological—of male circumcision (see listing under *RESOURCES*).

The attempt in this chapter to document the brief history of the current foreskin restoration techniques and movement is bound to be incomplete. It has been put together from bits and pieces of information and recollections. It truly is a patchwork quilt. Nonetheless, it seems important to collect the available pieces into a single document both for the sake of our own knowledge and in the hope that future generations who look back on this pivotal time in the history of human rights will find the pertinent information they will need to understand how this generation finally exposed the folly of a century of medical madness!

In the next chapter we will consider how human skin expands. We will look at some of the medical techniques developed for expanding the skin. And, we will consider various aspects of foreskin restoration using skin-expansion principles.

# 13

## Skin Expansion: How It Works and What It Provides

*“Like many inventions, controlled tissue expansion is an innovative application of a natural phenomenon—the ability of skin to stretch extensively over a slowly expanding underlying structure.”*

**Terri Goodman, R.N.**  
**Susan White, R.N.**  
**Saleh M. Shenaq, M.D.**

The small network of men in the early 1980s learning how to ‘stretch’ their penile shaft skin to form a new foreskin to cover their glans could not have known that at the very same time there were pioneers in the field of plastic surgery working to develop their latest discovery: tissue expansion! To date, tissue expansion as used in the various medical fields is a surgical procedure. That is, an incision is made at the location where the skin is to be expanded, and an inflatable device is implanted. The device is implanted either at a site from which the skin will be ‘harvested,’ or at (or adjacent to) the site of the reconstruction itself. The device is either self-expanding or is designed to be periodically enlarged, or ‘pumped up,’ to provide increasing tension. Such tension continuously expands the skin over the device until enough skin has been developed to allow for the needed repair or reconstruction. A second incision is then made through which the device is removed just before the further steps of surgery are performed. Breast reconstruction no doubt accounts for a large majority of the current cases of reconstructive surgery using such tissue-expansion techniques (1).

In July, 1987, the journal, *CLINICS IN PLASTIC SURGERY*, published an entire issue devoted to tissue expansion. In that journal, Drs. L.C. Argenta and E.D. Austad reported that:

During the last 10 years, it [tissue expansion] has emerged from being an experimental novelty to become a major reconstructive technique, and worldwide clinical experience now numbers approximately 50,000 cases (2).

Furthermore, when I first researched the medical literature, in 1991, in preparation for this chapter in the first edition, the library

### Men’s Voices...

“I don’t remember when I began the program but I am pleased so far, especially after having graduated to the ‘ring’—it’s such a relief to be able to urinate standing up again!

I have noticed plastic surgery articles describing ‘skin expansion’ as a technique of facilitating breast augmentation and surgical reduction of male pattern baldness—this makes me much more confident in the UNCIRC program!”

C.L., South Carolina

“Thank you for sending all the pertinent information on lengthening foreskins.

We have two sons and a daughter. Both boys have their original parts. The second boy was a hospital birth with all the attending intervention that is found there. We had to refuse circumcision four times while there—twice in writing. We later read about newborn’s foreskins being sold and used for burn grafts. Greed knows no bounds! He survived as did his foreskin, but we had to fight for it.

As I told you before, I’d been stretching my remnant for about two years. I’ve been using a

*(continued)*

### Men's Voices...

tape ring and a plastic device made from plumbing parts—complete with a hole for urination. I've been using tape and benzoin to hold it in place. I can urinate with the contraption on, and the stretch is provided by an elastic strap fastened to a wide elastic band under my sock around my foot. The length of the strap determines the tension. I've had this on for up to three days. I'm interested in your bearing device since it seems to eliminate the benzoin, which does irritate my skin, too. A hole could be drilled through it to allow urination also, and perhaps, an elastic band could be added to keep the tension even.

I have an 1 3/8" of extra skin now that totally covers my glans when the temperature is below 60 degrees F. Above this temperature, my penis tends to expand enough to uncover, so then a tape ring is necessary. My penis is one of those that shrivels up to about three inches when cold or exercising, and expands to eight inches when fully erect. I've got a fairly large glans. I have plenty of play now when erect and can pull my foreskin over the head. Both sex with my wife and by hand are more sensational and fun now. This addition to the family is definitely welcome.

My goal is to have that eight incher fully covered in warm weather! I wasn't cut too tightly but unevenly, so I've got less on the left than on the right. (My mother said the doctor was drunk—I suspect he was!)

I really hate to uncover my penis now. The regained sensitivity is uncomfortable rubbing on cloth.

I have always had a lot of anger especially directed at my parents. Some of it comes from my father's anger as he raised us—why was he angry? I think part of this may indeed be from our circumcisions. It is the supreme injustice to have a piece of you removed without your consent! I was fourteen before I knew what a foreskin was, due to our Victorian American ignorance of all things sexual.

In gym class one day, I noticed a boy with a 'deformed' penis and I asked him how he got that

(continued)

catalog at the University of California at San Francisco listed 198 journal articles dealing with various aspects of tissue expansion. That fact alone impressed me. When I returned, however, to the same database in 1994, in preparation for this updated edition of the book, the listings numbered 369! Obviously, the full range of expansion procedures, as well as findings and reports, in this field is well beyond the scope of this book. There are, however, certain findings and conclusions which bear directly upon the nonsurgical skin-expansion system of foreskin restoration as outlined in the following six chapters.

### How Does Skin Expansion Work?

Just as some of the first men who began to 'stretch' a new foreskin were impressed by the customs of certain indigenous peoples, some of the articles in prestigious medical journals also begin by noting the distended earlobes and lips among these same peoples. Further, the medical journals cite such human conditions as pregnancy, massive weight gain, and large tumor formation as examples of the "natural phenomenon" of tissue expansion (3). Over the last 18 years, the medical community has asked and answered several significant research questions relative to skin expansion.

#### Is the Increased Skin Surface New Skin or Borrowed Skin?

This research question continues to receive a great deal of attention. Some conclusions, however, have been drawn: 1) Some skin is 'recruited' from adjacent tissues and is drawn toward the point of tension. 2) There is some *initial* thinning or redistribution of locally expanded skin. 3) The total population of epidermal cells is increased (4). Dr. E.D. Austad concludes:

...tissue expansion elicits a dividend [produces a gain] of additional tissue: The total population of epidermal cell [sic] is increased. Recruitment of epidermal cells from neighboring locations probably occurs to a small extent, although this has never been experimentally quantified (5).

These findings from Dr. Austad's earlier animal studies have been augmented and refined in later research examining similar effects on human skin. In one such study, involving 20 patients undergoing breast reconstruction, Swedish researchers found:

...a distinct rise in mitotic [cell formation] activity in the human epidermis during tissue expansion leading to an increase in the number of cells. This suggests that tissue expansion generates a net gain of tissue not only by stretching but also by formation of new tissue (6).

**What Happens Over Time?** While the various layers of tissue which make up human skin undergo differing reactions to the expansion procedures, Dr. K.A. Pasyk, et al., reported in a 1988 article that

studies done two years *after* expansion was completed have shown that the tissues involved undergo “normalization” and that the overall thickness and composition of the skin are similar to its nominal state before the expansion procedure (7). More recently (1992), Dr. Maturri, et al., reported that follow-up examinations ranging from 12 to 42.5 months after expansion revealed that “...the skin appears to be normal from the points of view of color, texture, histomorphology [tissue structure], and function over [i.e. beyond] 12 months after expansion” (8). This study also compared biopsies taken from the expanded area and from the opposite, nonexpanded area of the body. Comparisons revealed that the expanded skin appeared completely normal. Finally, the researchers explored the effects of a range of factors such as age, sex, area expanded, etc., and determined: “None of these factors had a significant influence in the follow-up patients.”

The documentation of the tendency of the expanded skin to normalize over time both in microscopic features and in appearance is good news for men restoring their foreskin by nonsurgical skin-expansion procedures. These men frequently want to be sure that their new foreskin will look and feel like their normal skin. The medical research findings in this regard are also in line with the experience of the men with whom I am acquainted who have completed their program of foreskin restoration by skin expansion. The skin of their new foreskin does indeed seem to be of normal thickness and appearance. A friend of mine who has completed his restoration program recently went to a doctor for a physical examination. During the examination, the doctor noted that he did not see many men in my friend’s age group who “had not been circumcised.” I don’t need to tell you how pleased my friend was with that ‘observation’ since he had been rather tightly circumcised as an infant.

**Are the Results Permanent?** All of the data I have found suggest that the gain in the expanded skin surface is permanent. Further, I have discussed this question with several doctors working in related fields. I am assured that, if the process is done slowly enough over a sufficiently long period of time, there is every reason to expect the results of skin expansion of the foreskin to be permanent. This conclusion is also supported by the permanent distention of lips, earlobes, etc., accomplished by various indigenous peoples.

### **Skin Expansion Used in the Reconstruction of Male Genitalia**

Dr. Willard E. Goodwin notes in his 1990 article that “...penile and scrotal skin is especially notable for elasticity” and suggests the possible use of surgical skin-expansion techniques for foreskin reconstruction (9). We will, in fact, consider such surgical foreskin recon-

### **Men’s Voices...**

way. He said he was born that way and he promptly rolled his overhang over his glans and showed me how it operated. I was dumbfounded—he told me mine was circumcised when I was born. Two new words and concepts—that he was not deformed and I was the odd man out—and so were 90% of the rest of the boys. He let me pull him back a few times. I remember it feeling so loose.

I knew from that day on what an injustice had been performed on me and that someday—I didn’t know how—I’d have a foreskin, too.

Over the years, I’ve seen various penises with various foreskins and envied just about all of them—yes, penis envy. After three women, I realized I was above average in size, but I still felt scarred—the BUFF method and my variation have restored some of my wholeness. I feel better about myself these days—I realize more. My penis feels great being covered. My boys understand why I have a scar and why they have intact penises. They go ‘ouch’ when they hear of anyone being circumcised.

I know I’m not alone—thanks to you and thousands of others.

A Jewish friend of mine whose wife is a midwife never circumcised his boys. This caused a big stink in his family. I know, however, if he could be restored, he would. I firmly believe there are millions of mutilated men who want to be made whole. I believe it has hurt us to brutally cut off part of our penises—boys identify strongly with their penises. It seems diabolical to mutilate such a sensitive and important organ. Could this be part of the reason so many of us are angry and perpetuate violence? Violence perpetrated upon us before we can express it remains bottled up until it can be expressed.”

K.R., Iowa

“I was circumcised as an infant, and I’ve always felt I was not complete as a male and that I’m missing part of normal male experience. Ejaculation has been slow or absent when it was appropriate for the physiological reaction, causing

(continued)

### Men's Voices...

frustration and embarrassment. School locker rooms were a painful experience for me; I always tried to be inconspicuous."

M.D., Baltimore

"To give you a brief history, I am 42 years old and I was circumcised at age 13. The M.D. supposedly said I had a bad infection due to the fact that I never could pull the skin all the way back (this was when I was uncircumcised). Anyway, the M.D. performed the operation and circumcised me with very little extra skin. It's what I always thought of as a 'tight circumcision,' and one spot on the underside of my penis adhered to the corona which has always given me problems. Over the years, the skin on the shaft has become more loose (maybe due to gravity) and I feel that I could try the stretching technique. Any information you could send would be greatly appreciated."

B.J., Reno

"I have the same family doctor who delivered me and I asked him about my circumcision. He said he did what is called a 'dorsal slit'—an incision is made in the foreskin from the tip back to the corona on the top of the penis. This allows the skin to move freely, however, the sphincter is destroyed. During an erection my skin is easy to push up to the tip on the underside but widens out on top rather like a 'V.' If the two sides of the 'V' were sutured, my foreskin would be intact."

L.Q., Kentucky

"It has been my experience through the years that women have been the big promoters of circumcision. They think an intact penis is dirty. My grandfather died when my father was two years old, and a nurse friend of my grandmother talked her into circumcising him by the time he was three. However, my mother's father was a doctor and he did not do circumcisions.

My mother and father decided not to have me circumcised, but my mother believed in cleanliness and wanted to retract my foreskin for 'proper washing.' She told my wife (when our oldest son was not circumcised) that I had a tight

*(continued)*

struction using skin-expansion techniques in Chapter 20. Before doing so, however, it is encouraging to note that surgeons have reported the successful reconstruction of other structures of the male genitalia using skin-expansion procedures.

Two different cases of scrotal reconstruction using skin expansion are reported in the current literature. Drs. E.F. Still, II, and R.C. Goodman, in 1988, reported the case of an accident victim who had lost his scrotum when his clothing got caught in machinery (10). And, Drs. J.K. Lattimer and M.C. Stalneck, in 1989, reported a case in which one side of the client's scrotum was undeveloped due to an absent testicle (11). In each case, implanted expansion devices were used. In one case, the device was used to enlarge the existing scrotal tissue; and, in the other case, to raise an entire, new scrotum from hair-bearing perineal [between the scrotum and the anus] skin. In both instances, the photographs of the final outcome show results which are impressive, to say the least!

### Nonsurgical Foreskin Restoration Using Skin-Expansion Principles

So far in our consideration of skin expansion, we have looked at the current literature in plastic surgery and related surgical fields. And, of course, the medical literature also includes articles discussing the surgical risks and possible complications associated with using inflatable devices, etc. The good news for most men considering foreskin restoration is that the skin-expansion system as outlined in this book does not require surgery. As long as the circumcised male has sufficient relatively hairless shaft skin to expand, nonsurgical skin expansion offers an attractive alternative to surgery.

The basis of the system is very simple. By the use of a series of taping methods and procedures and of simple devices which provide gentle, prolonged tension, the penile shaft skin is expanded to provide additional skin which eventually re-covers the glans with a retractable skin hood: the restored foreskin. I have often said, when discussing the skin-expansion system of restoration with groups of men, that you have to 'fool' the penis into believing that it is growing to incredible lengths and it simply must provide the skin needed to cover its new dimensions! In the first two stages of the system, the glans and the penile body itself provide the necessary tension; in the final stage, various devices are used to provide the needed tension.

### What to Expect from a Restored Foreskin

In Chapter 11, we considered the various reasons men give for seeking foreskin restoration. Here, I would like to briefly discuss the actual physiological changes reported by men who have restored their foreskin. Compared to their circumcised state, most restored males

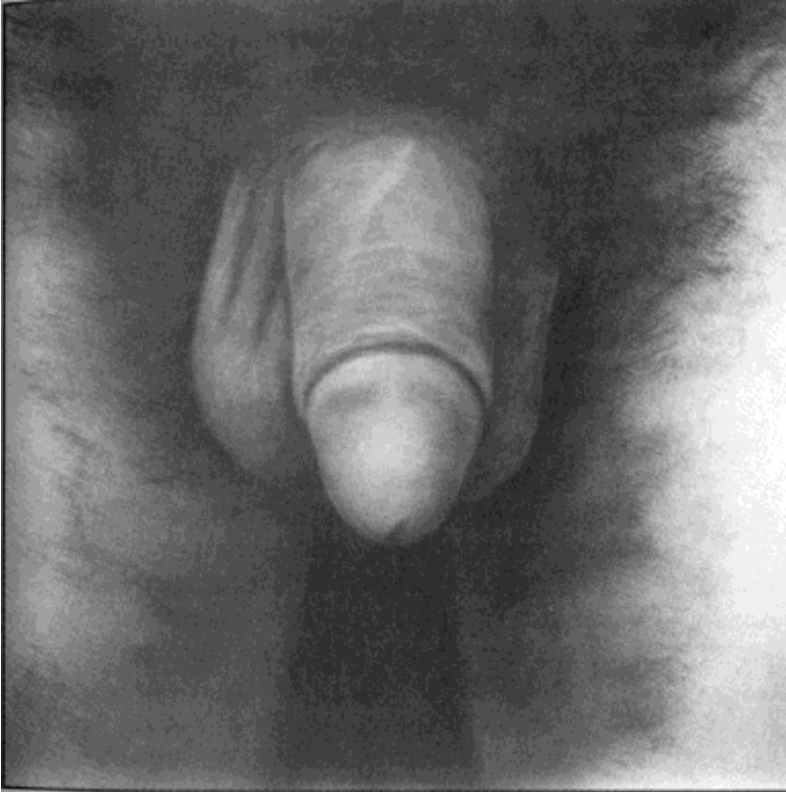

Figure 13-1 Before restoration begins, this man, as is typical, could not pull his shaft skin over his glans in the flaccid state. (This, and the following two photos, are retouched only to protect the subject's identity.)

report phenomenal gains. Visual progress is also dramatic, as shown in Figures 13-1 through 13-3.

**1. Sensual Sensitivity of the Glans and Mucous Tissue.** The gain in sensitivity is the first and most consistent benefit of restoration. Within a very short time, for most restoring males, that portion of the glans which is covered by the shaft skin becomes more moist and typically changes texture, sensitivity, and often color. Not only does the glans regain sensitivity, the mucous tissue which is typically between the glans and the circumcision scar also becomes much more responsive for many restoring males. As a matter of fact, one of the frequently cited incentives for continuing the program, once it has been undertaken, is that the newly sensitized glans does not feel comfortable rubbing against clothing again if the individual leaves the tape off for some reason. Actually, I have had men tell me that, once they are able to completely cover their glans with skin, as in the tapering stage of the system, they would wear the tape for the rest of their life, if need be, rather than lose the sensitivity they have regained.

### Men's Voices...

foreskin and was circumcised to afford better cleanliness. I now think she had forced my foreskin back and it had gotten caught behind the glans. I have a slight scar/notch at the center top of the corona of my glans where I think my foreskin was cut to free it at the time I was circumcised.

In talking with men, I find that 95% who still have a foreskin are glad they still have it and would not dream of having it chopped off. Most of the circumcised ones (like my brothers) are not concerned that they have no foreskin. However, about 10% of the those circumcised are anticircumcision.

I want to thank you for the list of doctors who do foreskin operations. Now I have a point to start from. However, I was surprised that no Southern California doctors were on the list. It reminds me of when I was trying to get a vasectomy 35 years ago—I was laughed out of about 25 doctor's offices until I found a skilled doctor to do it. Now any man can open the yellow pages, find a doctor, and in many cases, be sterilized that day. I am 90% sure that I will have someone restore my foreskin before another year is out. Now I want to talk to those who have had it done and learn what happened and how good it has been."

S.E., Escondido

"There is no standard on how much to cut off, and even if there was, one cannot judge very well on a baby. When too much is cut off, erections are painful. Too much was cut off of myself, when I was mutilated as a baby."

C.B., Oklahoma

"My situation is as follows. During circumcision, too much skin was removed and the mistake was 'corrected' by grafting skin to my penis shaft. The graft was to replace missing skin on the shaft, not to allow for additional skin around the glans. The lessening of sensitivity, while no doubt present at the glans, is most noticeable at the graft site which covers approximately two-thirds of my penis when flaccid and approximately one-third when erect. It also appears that the graft has not

(continued)

## Men's Voices...

allowed for full penis growth as the shaft below the graft is thicker than the graft area itself. I've never been made aware of skin grafting being used to correct misperformed circumcisions."

M.H., Boston

"As is Jewish tradition, I was circumcised at eight days by a man called a 'mohel.' Apparently, he removed the foreskin further down the penis than was healthy and the error had to be corrected in the form of a skin graft when I was five years old."

M.M., New York

"My grandson was circumcised at birth (sorry to say). I'm told it was not done correctly. He is three years old and he has adhesions, or is it scar tissue. My daughter is hesitant to have it corrected at this time. I wonder if it should be left alone."

E.I., Colorado

"My husband had a 'radical' circumcision done at birth. We recently discovered this problem, and in conferring with the doctor, found out that almost all his shaft skin was removed, not even enough was left to go around the penis. Foreskin was attached to the scrotum. This lack of skin has caused many problems, including very tight skin over an erect penis."

M.W., Colorado

"I would be very interested in any information on types of foreskin restoration available, as well as names of doctors and hospitals who perform this service. I asked several surgeons and a urologist in the area. The urologist thought it was funny that I didn't like being circumcised. I was cut at birth and hate being cut. He is straight, but let me measure his hard and flaccid penis shaft, scrotum, frenum, foreskin, etc. I lost three and three-quarters to four inches of penile skin when circumcised, and my scrotum and pubic hair pull out on my shaft when erect."

R.M., Michigan

"For some reason I have been finding the question of circumcision more and more bothering. It has been many years since I have been cut, but I was

*(continued)*

Many members of the medical community are still unaware of the regained sensitivity of the glans which men who restore their foreskin experience. In response to a reader's inquiry about foreskin restoration and its possible effect on the sensitivity of his glans, Dr. James Gilbaugh, in MEN'S HEALTH, first assured the reader that surgical restoration was possible then went on to say:

On an emotional level, maybe having your foreskin restored will help you resolve anxieties about invasion of your privacy, physical violation and your mother's insistence on you being circumcised.

Physically, however, I doubt that replacing a flap of skin will make your glans more sensitive. For one thing, there's no evidence that uncircumcised men are more sensitive than men without a foreskin (12).

Let me state again, regained sensual sensitivity or responsiveness of the glans is the first and most consistent result reported by men who are restoring their foreskin.

**2. Mobility of the Shaft Skin.** Many men report that the expanded penile skin moves on the shaft of their penis in a new and exciting way. I have talked with doctors about this phenomenon. The



Figure 13-2 Progress at 18 months. Partial glans coverage has been achieved



speculation is that the connective tissues which underlie the penile covering itself elongate during the various skin-expansion procedures. Many circumcised males have such tight shaft skin that during an erection there is virtually no movement of the penile covering on the shaft of the penis. By consistently taping the shaft skin forward over and in front of the glans, a greater degree of mobility is systematically achieved. The result is that during sexual activity, particularly foreplay, the shaft covering is rather easily stroked onto and over the glans in a manner which was never before possible for these circumcised men.

**3. Added Skin Surface.** It may seem strange to discuss the enhanced sensitivity of the glans and the mobility of the shaft skin before discussing the additional skin itself. But, actually, this is the order in which the benefits are typically experienced. Long before the restoring male has enough expanded skin surface to see his new foreskin begin to stay in place without tape, he is enjoying the enhanced sensitivity of his glans and the increased mobility of his shaft skin.

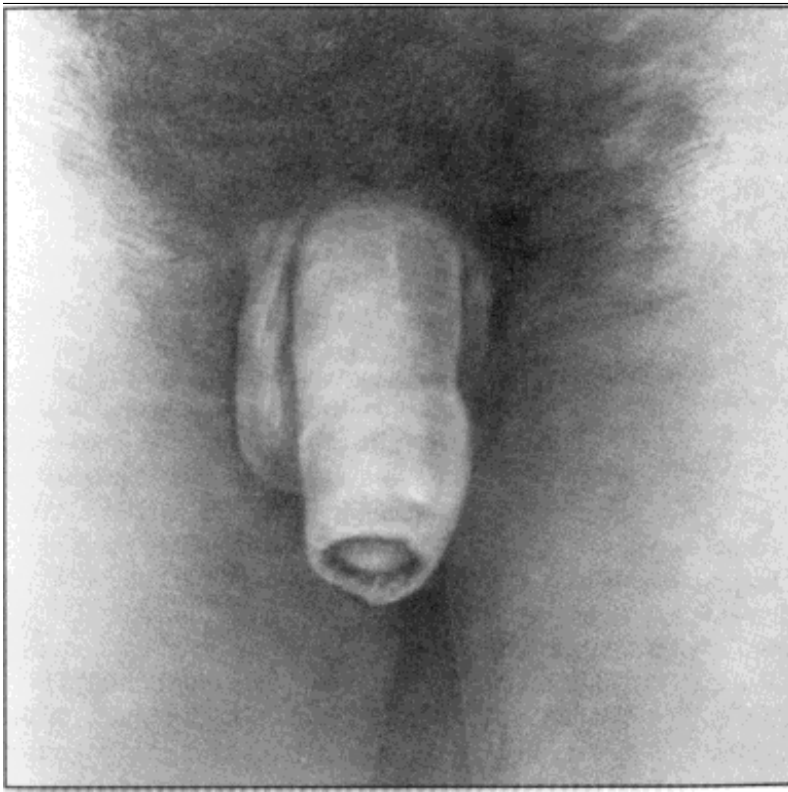

Figure 13-3 Progress at 36 months. The glans is completely covered. Appearance is much like a penis that has never been circumcised

### Men's Voices...

cut at the age of 11. As the years have passed, I find that stimulation is difficult to achieve. It seems as though an excess of manipulation, almost to the point of pain, is necessary to achieve satisfaction."

V.T., New Jersey

"The subject of circumcision causes me a great deal of emotional pain. Although it has been over five years since the last of four scar revision operations that I underwent to repair the damage caused by a poorly done circumcision, the pain and humiliation that I experienced are still fresh in my mind."

S.H., San Francisco

"I am a 35-year-old 'very' circumcised male, and have been very disheartened as to the removal of my foreskin at birth. I stated 'very' since the doctor did what I consider a too close shave. I am interested in information on methods, both surgical and non-surgical, to attempt to return my manhood to its natural state. If not to the point of having a normal and natural penis with the foreskin that God intended, to at least find a way to stretch the tissues as to keep from having such discomfort during an erection. I have always been jealous of those who were not butchered at birth."

K.B., Texas

"I don't know about you, but I myself was circumcised. And although I requested the information out of curiosity, I am now shocked and appalled that such a disgusting and cruel fad could persist, even under doctors who are supposed to help people, not mutilate their genitals and deform children. I am seriously interested in performing 'non-surgical' restoration on myself and, if it works, let others in on such a wonderful opportunity to be as God designed us. Could you please send me details and instructions on the procedure and perhaps your own views and opinions on it?"

S.L., Vermont

But, of course, visible skin over the glans is the goal of foreskin restoration. As men progress through the system, my phone often rings: “Guess what?...I now have a collar of skin beginning to hang over the rim of my glans!” “...My glans is half covered now—when I’m very small!” “...I can stay covered for several hours now before the skin creeps back off the glans!” “...I’m covered all the time now!!!”

**4. “Pleasure Dynamic.”** With the typical circumcised penis, all tissues and objects which touch the glans are foreign to the penis itself. It seems, however, just as with the female clitoris, that the natural hood sliding over the glans is the most appropriate and satisfying stimulation until later in the orgasmic sequence near the point of ejaculation. As the restored foreskin lengthens, many men do, indeed, regain a very satisfying degree of this stimulation function, the “pleasure dynamic” as Dr. Ritter has labeled it (Figure 2-4) (13). I recall one man who said, “For the first time in my life, I felt my own foreskin stroke my glans during intercourse!” He was in his late 50s.

**5. Gliding Mechanism.** Whether an individual regains enough skin for it to stroke his glans during intercourse or simply a greater degree of mobility of the shaft skin, the added comfort of having such mobile skin during intercourse is a very real benefit of the restored foreskin, and this benefit is typically appreciated by both partners.

## What Not to Expect from Foreskin Restoration

There are two particular features of the natural foreskin which are not regained by restoration, and it seems important to have realistic expectation of a restored foreskin.

**1. The Frenar Band.** In discussing the natural penis in Chapter 2, we noted that Dr. John Taylor has labeled the narrower band at the tip of the natural foreskin the ‘frenar band.’ Any degree of circumcision, loose or tight, removes this feature of the foreskin. The restored foreskin does not typically narrow to hug the tip of the glans in the same fashion that a natural foreskin would. The result is a restored foreskin which more easily retracts off the glans than most men would like.

**2. A Functioning Frenulum.** Even those men who were circumcised in a style which left a good bit of the frenulum in place typically find that it has been damaged or ‘disconnected’ as a result of their circumcision. This mechanism normally functions to limit retraction of the natural foreskin during an erection or intercourse. And it helps to pull the foreskin back over the glans and retain it in place when the erection subsides. Without an intact frenulum, the restored foreskin must often be replaced back over the glans manually after it has been retracted by an erection, for bathing, etc.

## Surgical Touch Ups to the Restored Foreskin

The absence of the frenar band and a functioning frenulum seem trivial to many men when they compare their restored foreskin to their circumcised state. There are, however, some men who are not satisfied unless their restored foreskin will stay in place over the glans at all times, at least when their penis is flaccid. For these men, a surgical reduction of the opening (orifice) of their new foreskin may well be the solution. We will discuss the techniques and the pros and cons of surgical touch ups in Chapter 19.

## The Restored Foreskin

In Chapter 11, we looked at typical reasons men give for wanting to restore their foreskin. These reasons nearly always reflect a desire to get back what was lost by circumcision; therefore, the tendency is to cite the features of the natural penis as the ideal. The same tendency often causes men considering the pros and cons of restoration to compare the restored foreskin with the natural foreskin. For the circumcised male, however, the only valid comparison, or choice, is between a circumcised penis and a penis with a restored foreskin. When that comparison is focused on, the benefits of a restored foreskin are both delightful and astounding. As one man put it, “Restoring my foreskin was the best thing I ever did for me!” (14).

In the next chapter, we will consider many of the issues involved in getting started in a program to restore your foreskin using the skin-expansion system.

## Voices From Abroad...

"I am very interested in finding out more about any support groups for men who are annoyed at having been circumcised as children, without consent.

As you may know, Australia was just as diligent as the U.S. in promoting and performing 'routine' circumcision until about 15 years ago. The rate now here is down to about 35% from what I have read, but back in the early 1950s it was running around 85-90%, and very few boys escaped.

My parents were apparently very against it, and despite pressure from doctor and hospital, childcare center, etc. I was not circumcised in infancy. The trouble started when I began primary school, as from year 2 they started yearly medical check-ups by a government medical team. In grade 4, when I was eight, the examining doctor and nursing assistant both were amazed, and seemed quite annoyed, at the fact I was one of the few boys there intact. I still recall the nurse exclaiming when I stepped up for the routine examination that '...good heavens, doctor, here's another boy who still hasn't been circumcised!' After a letter was sent to my parents (no doubt heavily promoting circumcision for hygiene reasons, etc.), there was much deliberation but unfortunately I was taken to the local doctor's surgery and more or less dragged into the operation. Incredibly, even at that age I knew, using simple logic, there was no real need for it to be done, and I couldn't understand why anyone would actually do such a painful thing to a child.

I cannot really now remember the details (probably just as well!) but I do know that even with several frightening injections at base and head of the penis, it hurt like blazes, and I had to stay at home for two weeks while healing

took place. Worse, for the first week or so I could only wear a small cotton tennis frock without underpants, and felt a total fool, even staying in our backyard, etc. Some sort of liquid (antiseptic?) was swabbed daily where the wounds were, and this burnt like hell, too. After two or three weeks I was again taken to the surgery, and after some more swabbing, the scar scab was soaked off and the nurse exclaimed that, 'All over now, and you look a real man too...' I had no idea what this was all about, of course, just that I had gone through a lot of pain and discomfort for no reason I could work out. I have heard of other boys who had been pressured into having the circumcision done during school years, and only over the last 15 years or so, have also heard from parents who were virtually conned by school doctors or infant welfare centers and kindergarten doctors into having boys circumcised. Usual reasons given were either 'better hygiene,' 'foreskin too tight or too long,' or 'stops masturbation.' It's hard to realize all this still went on, in a civilized country, until about 1970!

My main problem after the circumcision was great discomfort from the clothing friction. It was excruciatingly uncomfortable, and walking to school or taking part in sports, etc. was like constant sandpaper rubbing across the head and shaft...the ridge being worst affected. While, in lurid literature, giant erections are a sign of a 'stud,' in real life, constant erection caused by the friction of clothing is distressful...particularly for 10-year-olds! I am wondering if this aftereffect of circumcision (e.g.: unwanted, continual stimulation) has been widely considered? Now, I think most who are circumcised would suffer from it. At school,

even then, often boys (all circumcised) would say, 'Gee, my penis is giving me a lot of trouble today and won't go down,' and this was usually when walking or during sports, etc. At puberty, due to the growth of the body (and the penis, etc.) the unwanted continual friction was horrendous. I had heard of some boys then who tried crude means of trying to protect the circumcised penis...one method employed the cardboard tubes toilet rolls were wound on! In teen years, I have dreadful memories of twice being on marathon walks with the class, and like several other lads, found the sandpapering continual stimulation of the unprotected organ culminated in ejaculation. A ghastly, embarrassing affair, that in retrospect makes one very angry that 'routine' circumcision could be the cause of all this discomfort. The Creator gave us the shielding foreskin for a very good reason I have concluded!

At age 42, I now have a very desensitized penis, indeed. It has happened slowly, but I would say from about 25 onwards, the remaining sensitive skin slowly got harder and tougher, and seemed to slowly lose that beautiful, exquisite sensitivity experienced as a child or teenager. From what I have been able to read over the last five to six years, I presume this is normal for most men who have been circumcised. Can you confirm this, or add to it? In the excellent (but recently discontinued) *Forum* magazine of Australia, some women interviewed said they did like a circumcised older male as he could really satisfy them by continuing lovemaking for a long time without climaxing. I can vouch for that, however, it is cold comfort for the poor male who derives little stimulation from this."

H.J., Australia

# 14

## The Skin-Expansion System Getting Started

*"I wish I would have known about it before. It is simple and inexpensive."*

**B.T., Syracuse**

### Men's Voices...

"I started the stretching program just over one year ago after reading an article. I started out using band-aids to hold the skin in place, but it became obvious that even though the band-aids held well they had problems: the adhesive wore out, bleeding occurred when the area became hot, and the band-aid looked dirty after several hours of wear. I tried several tapes and finally decided to use Dermiclear. This tape holds very well and can be removed and reapplied numerous times. The tape does not wash off in the shower and feels like skin, plus there is no irritation from continuous wear. I wear the tape 24 hours a day and use the one strap side-to-side method. The only frustration I have had with the taping is that I could not find a method of wearing it where urinating was not messy. I tried punching a hole in the tape as described in some of your information, but the weight of the glans pushing against the hole all day caused minor discomfort; therefore, I stopped using the hole method. I tried to sit down to urinate, but this caused a spraying effect and was somewhat messy. I finally decided on removing the tape each time I went to the bathroom.

After I had been taping for about three weeks, I noticed that the color of the glans was changing and was becoming a darker red. The glans itself

*(continued)*

It seems appropriate to begin this chapter with the same notice and recommendation which have always been a part of any instructional material distributed by UNCIRC: The following instructions (Chapters 14-19) should not be construed as medical advice. The information does not necessarily apply to any particular individual. It is recommended that the individual who is considering foreskin restoration by means of the skin-expansion system work throughout his entire program under medical supervision. In order to do so, the individual should find a doctor with whom he feels comfortable. Finding such a doctor may necessitate taking the risk of being ridiculed, but, with persistence, it should be possible to find a sympathetic doctor with whom to work. Use the following information to acquaint the doctor with the principles and procedures used in foreskin restoration by skin expansion if he is not yet familiar with the methodology.

In this, and the following three chapters which present the three stages of the nonsurgical skin-expansion system, certain terms have been used consistently:

**Taping Method:** refers to whether or not the tape strap or ring is applied directly to the skin *and* for what duration it is worn.

**Procedure:** refers to the duration of wear *and* the means by which the tension on the skin is produced.

**Configuration:** is applicable in Stage I only and refers to the actual pattern of the tape strap(s) on the penis.

**Expansion Device:** refers to any implement, other than tape, worn to create tension on the penile skin.

### Supplies and Implements

One of the major appeals of nonsurgical restoration by skin expansion is that it is inexpensive by virtue of the very few supplies required, particularly in the first stages of the program.

**1. Tape.** The one supply which is needed by every individual is the appropriate tape for his particular needs. No single aspect of a taping program typically involves as much trial-and-error discovery as finding the right tape. Such factors as allergies, sensitivity, and even availability must be considered. A list of the sorts of tape men have tried, from simple white adhesive tape to masking tape, including electrician's tape, would probably include most tapes available on the market today.

It seems wise, however, to choose a high quality, nonallergenic 'surgical' tape readily available in most drug stores. The gentlest, in terms of adhesive strength, are the nonallergenic paper tapes: 3M Micropore, Curity, J&J Dermicel, etc. It is suggested that the individual start with one of the paper tapes since these tapes can usually be removed with little or no discomfort should the need arise. Some men find, however, that such paper tapes do not have enough adhesive strength. As long as no skin reaction has occurred while using a paper tape, adhesive strength can be increased by switching to a nonallergenic cloth tape: 3M Durapore, J&J surgical cloth tape, etc. Some men prefer the so-called 'breathing' tapes made of clear plastic mesh: 3M Transpore, J&J clear tape, etc. Other men find a clear, lightweight, and moisture-proof tape most suitable: Blenderm by 3M for instance. Finally, some men find elastic or stretchable tape most useful: Elastoplast, J&J Elastikon, Curity Conform, etc. Cellophane tapes and "Magic Tape" are not satisfactory since their sharp edges can cut into the skin.

Each individual must find the tape which works best for his skin and also provides the appropriate strength of adhesion for his particular needs. I occasionally suggest to an individual that he wear short strips of two or three different brands and types of tape on a hairless site on his inner thigh or underarm to check for any possible skin reaction and to test how each tape remains on his skin. After years without a foreskin, an additional day or two invested in finding the best and safest tape seems an appropriate safeguard.

The two most popular widths of tape are 1/2 inch and 1 inch. Again, trial-and-error discovery will probably be necessary to determine which width is best for your needs. Actually, many men use both widths at different times and for different taping needs throughout their program. The factors which determine the appropriate tape width at any one time are: 1) the stage at which you are working, 2) the taping method you have chosen, and 3) the circumference of the shaft of your penis as compared to the actual size of the glans.

Before leaving the subject of tape selection, two additional products should be mentioned. 1) Self-sticking gauze: This product sticks to itself rather than the skin, and some men find it a particularly useful material from which to make the tape ring during Stage II.

### Men's Voices...

was also becoming sensitive. I also noticed that the skin on the shaft directly under the glans was becoming very sensitive and today it is very sensitive to any type of simulation. The shaft skin started to become noticeably loose after about six weeks. When I had first started taping, the skin was very tight and only covered about a half an inch of the glans. I continued to tape on a daily basis, and after a few days of being aware of the tape, I finally got to the point that if I did not have the tape on, I felt like something was missing and the glans rubbing on my clothing was uncomfortable—I got to the point after about nine months of taping where it seemed like the shaft skin would roll very easily up onto the glans but did not seem to be stretching (the skin would roll up and cover the glans completely), so I came up with the idea of extending the skin further. I made an extension of about one inch and a half of heavy duty foam rubber, scooped a hollow inside so that the glans would fit inside, and then rolled the skin up over the extension and taped it in place. I am at the point where the shaft skin will stay completely over the glans if the morning is cool, but as the day goes on, the skin will slide back so that there is only about half coverage of the glans. If I do not tape by the end of the day, the skin will have bunched up around the glans so that only the rim of the glans is covered. I have decided to tape daily and not take any 'rest' days—I used to only tape once in a while, but I felt that missing days was not helping.

I have been stretching without direct medical supervision. I work in a large medical facility and am in contact daily with doctors regarding various issues of the facility. I raised the issue of circumcision with several of them who I know personally. One asked to see the literature, so I gave him the package of information and also told him that I was participating in the stretching program. I met with him a week or so later and we talked over the various issues of circumcision. He saw no reason for me not to continue (we are on a friendly basis and enjoy various after work

*(continued)*

## Men's Voices...

activities). He took a look at how I was taping and checked to make sure there wasn't any damage.

When I went to him about two months later for him to check my progress, we discussed the pros and cons of circumcision, and he told me he was not circumcised. We talked about the benefits of being uncut versus the down side of being uncut. He said that at various times while dating several women, once they found out he was not circumcised, refused to have any sexual contact with him because they felt he was weird and unclean. He also said that he dated women who were fascinated with the extra skin. Usually the matter of a foreskin does not become an issue for him, but there is always the chance that someone will freak out and insist that he wear a condom. I asked him if he ever thought about being circumcised, and his response was that after being uncut for 37 years, he felt no need to have it done now. And if he met someone he wanted to marry and the foreskin became an issue, he doubts he would have it done either.

I had never actually seen an uncut penis, so while we were talking he asked me if I wanted to see his. He showed me how the skin covers his glans except for about a half inch at the end, and he rolled it back. I guess you could say that I was given a first-hand demonstration of how an uncut penis looks with the skin in place and uncovered. I do not want you to think we are kinky. We are very comfortable and open with each other and feel no embarrassment about discussing topics such as circumcision. He has also started to stretch his foreskin so that he will have total coverage plus overhang. He has been taping for about three months, and the last time we spoke about it he was doing fine.

My penis is 4 1/2" flaccid and 8 1/4" erect. When I started with the stretching method, I was hoping that if I could stretch the skin, it would ease the pain when I had an erection. I used to suffer from painful erections because the skin became so tight I thought it would tear. Now the skin has stretched to the point where it has some slack when I am completely erect, and I intend to keep

(continued)

Several products are available: Gauztex, Gauztape, 3M Coban, etc. The narrowest width of any of these products found so far is 1 inch; therefore, most men trim the gauze lengthwise to a width suitable to their particular need. 2) Transparent dressing: This clear, very thin product adheres directly to the skin for several days at a time. And some men use it, rather than tape, to form the 'skin guards' described in each stage of the system. Such products are usually available only from more specialized pharmacies dealing in home medical supplies. While a variety of transparent dressings is available, the only one known to me by name is 3M Tegaderm. As with any product applied directly to the skin, care should be taken to check for possible allergic reaction before regular use is undertaken.

**2. Scissors.** A good, sharp pair of scissors with slender, pointed blades will be very helpful in fashioning the various tape straps or rings. They are also indispensable if one elects to fashion his own foam rubber cones during Stage III of the program.

**3. Tincture of Benzoin.** This product is also known as 'Friar's Balsam' and is sold in most drug stores. When this liquid has been applied to the skin and allowed to dry, it provides a tacky surface for the tape to stick to. Not everyone needs to increase the tape's adhesiveness by using this product, but some men with particularly oily skin do find it helpful.

## Cautions

A word or two of basic caution seems appropriate before anyone attempts even the simplest phases of the skin-expansion system. As a circumcised male, your penis has already had enough wounding! Simple precautions can assure that you will not inflict any further damage to it. There are three 'DON'TS' to remember:

**1. Don't Cause or Endure Pain.** Pain is nature's way of telling us that some sort of damage is being done. *Nothing involved in this entire program should cause you pain!* If you are in pain after applying the tape, remove it. Something is wrong! Either your skin is reacting to the particular tape you are using, you have begun to tape in a style for which you are not yet ready, or you have somehow applied the tape improperly. If an erection while wearing the tape causes pain, remove the tape at once. We will consider the problem of nocturnal erections with the tape in place later in this chapter.

**2. Don't Be Overzealous.** The use of clamps, stiff elastic, heavy weights, or any such device which may seem to speed the process should be avoided. Only gentle, persistent tension is needed to achieve the desired results. There is *no* advantage to force.

**3. Don't Cause Constriction.** The blood supply to the skin should never be interfered with. And, if you follow the instructions carefully and observe the cautions, you should have no trouble. If you are in any doubt, however, there are three ways to tell if the blood supply is being restricted:

- 1) *Pain:* If simply wearing the tape causes pain, the tape is too tight. It *must* be loosened.
- 2) *Color Change:* If the skin near the tape turns blue and feels cold, the tape *must* be loosened.
- 3) *Pressure Test:* If you are in any doubt about blood circulation, test for constriction by pressing the skin firmly between your thumb and index finger for about 15 seconds. Take your fingers away. The spot where the skin was pressed will be lighter in color. If it does not return to normal color within 6-12 seconds, the blood flow is impaired. The tape *must* be loosened.

### The Fun Side

A little later in this chapter we will look more seriously at some of the particular issues involved in going about the daily routines of life while restoring your foreskin using the skin-expansion system. It seems appropriate, however, to point out as early as possible that amid the awkwardness and the inevitable adjustments to routines there is a real fun side. Perhaps it is nothing more than the simple, mischievous joy we all experience when we have a 'little secret' that we are keeping. It is the joy of 'I know something you don't know.' At UNCIRC, we hear from doctors, ministers, school teachers, computer engineers, construction workers, truck drivers, etc., etc. You can just imagine the social situations these men are in and the thoughts which sometimes pop into their heads. Imagine, for instance, being a minister in the pulpit with your vestments on and suddenly realizing just what some of your congregation would think if they only knew that, at that very moment, you were wearing tape on your penis and restoring your foreskin! Some men find themselves chuckling right out loud. Far from the dread of discovery, which after all is quite controllable, many men report a little rush of delight and satisfaction as they realize once again that they are doing something for themselves at a very personal and private level and that they've got a little secret which they are keeping from most of the world.

### Solving the Problems of Wearing Tape on Your Penis

The goal is to be able to wear at least the tape on your penis virtually around the clock. Only constant, gentle tension will cause the skin to

### Men's Voices...

stretching until I have some coverage while erect. Since I started to stretch, my glans has become very sensitive to stimulation and the skin around the shaft under the glans is also very sensitive. When showering, the glans feels very sensitive to the water and sometimes I become erect from the water hitting the glans. Contact during sex has increased the sensation dramatically. Sex has become very intense, and the difference between having an exposed glans for years and then going through the stretching program to regain the sensitivity and having all of these new sensations is unbelievable. I also indulge in masturbation more than I used to—the sensations of the skin slipping back and forward over the glans is very erotic and, in fact, I spend more time enjoying the sensations and experimenting. I like to use some type of lubrication, and spend time experimenting with the new sensations in the glans as well as the shaft skin. I take a lot longer reaching climax than I did before, and the climax is more intense; the longer I experiment before climaxing, the more intense it becomes.

I do not hold my parents responsible for my circumcision. I treat it as something that was done as part of being born. I have no anger towards the doctor either. I grew up in an environment where all boys were circumcised; if you were not, you were the odd ball. I never brought the issue up with my parents and probably never will. I will just complete the stretching program and restore the skin as best as possible. I might also add that I am doing the stretching program solely as something I want to do for myself. My girl friend has said that if that's what I want to do, it's fine with her.

Also, I moved to the tape-ring level today. I never seemed to have quite enough skin until I started to use the extension device I made."

N.E., Santa Barbara

"I have two grown sons who are not circumcised. Both have thanked me for fighting off the doctors, their mother, and grandparents. Thank you for your work and dedication to material such as

(continued)

## Men's Voices...

this—I only wish I had it years ago. I've always wondered if there were others like myself who hated being circumcised. I thought there was nothing that could ever be done about it. I started taping similarly to your method when I was 16 years old. I was afraid I would get caught. I didn't see much improvement so I quit after a couple of weeks. Over the years, I pulled on and stretched my foreskin (as much as I had) every chance I could. I saw a little change over the years, but not much. About nine months ago I started again about four to six hours a day using the tape the same way you describe. Within a couple of months, I saw a big change much to my delight!"

L.E., Louisville

"I just want you to know how excited I am about beginning the stretching process! I will begin to wear the tape today, but my only remaining question is how long should this take? My skin is tight, so I assume I have a long wait before I see results."

B.B., Akron

"Since 1979 when I read an article in *Hustler* magazine blasting male baby mutilation, I became interested in the pros and cons of circumcision. In 1980 and 1981, I had two sons and I refused to even discuss getting them circumcised. When I got divorced in 1987, while in another state, my ex-wife had my oldest son circumcised (at the advice of her doctor) without consulting me. He was supposed to have had phimosis. If I was there, I would have stopped it. Lightning struck twice for me.

On my 40th birthday, I told my mother about my anger and resentment on being circumcised against my will with no anesthesia. She apologized to me and said it was the doctors who coerced her and my father to consent to it. I feel better now. My father consented to it. He is intact. In 1951 circumcision was extremely routine. Thank God people are waking up. I write many letters trying to stop this madness. I talk to everyone I can about it. I do everything I can.

(continued)

expand in order to accommodate the mild tension which you are exerting on it. Further, it is the consistent covering of the glans which results in the glans regaining its more natural sensitivity. Of course, the tape must be removed at least periodically both for hygiene and for sex, but, if you do not wear the tape *nearly* 24 hours a day, progress will be even slower than usual. Thus, the challenge: How do you go about your regular routines of life with tape, and other devices, on your penis?

**1. Urinating.** This relatively frequent body function creates several problems. First, any method you choose for holding the skin forward over the glans must allow for urination. Therefore, you will probably need to experiment a bit at the beginning of each stage to determine the best taping method for your particular needs. Second, most men with tape or any other device on their penis choose the privacy of a stall when out in public, and many learn to urinate sitting down. Finally, most males habitually 'strip' or shake the last few drops of urine from their penis. If you select a taping method or procedure which requires you to urinate with the tape in place, that is not always easy. For the first time in your life, then, you may discover that blotting with tissue will become a necessity if you do not want the embarrassing results of dribbling after urinating. Just be aware that many intact males regularly use such precaution. See how fast you are becoming natural!

**2. Nocturnal Erections.** Most males typically sleep through their nocturnal erections. Indeed, any number of older males have been advised by a doctor to wrap a ring of postage stamps around their penis at night to check that they do indeed experience the usual spontaneous erections during sleep. But, tape on the end of your penis during sleep is a very different matter. Again, the rule is no pain! This rule can become a little blurred here. When you awaken at night for the first time with a nocturnal erection 'captured' by tape inside the penile shaft skin, the look and the sensation can be a little *weird* to say the least. Your penis may well look 'deformed,' and probably some of the tape will have been pulled free (especially if you have used the safer paper tape), and you'll be trying to figure out what to do. At first, the best thing to do is to loosen the remaining tape and go back to sleep. Next morning, start all over again with the tape in a slightly different configuration. Some men find that they simply cannot wear the tape at night for the first little while of their program. The surprising thing is that most men discover that in just a few weeks the penile skin is accommodating their nocturnal erections quite comfortably, and they are once again sleeping in their usual pattern as though they were not wearing tape at all. I will leave to your imagination some of the stories I have heard of men awakening in the night with a stunted or



misshapen erection trying to decide whether or not to remove the tape, attempt urination, or just try to go back to sleep. If attempting to urinate is the choice, how to do it? Necessity truly is the mother of invention!

**3. Showers and Baths.** Tub baths are good for softening the skin before applying the tape and for removing the tape; they are not suggested, however, for those times when you want to bathe but leave the tape in place. For that purpose, a quick shower is best. Whichever tape you use, you'll find that the sooner you can dry it off after your shower the better it will remain in place on your skin. A hair dryer on low heat is very handy for blowing the tape dry after it has gotten wet. Cloth tape, for instance, dries out in about 30-40 seconds when a hair dryer is used. Showering with paper tape is less satisfactory, but some men do so.

As to hygiene, the American culture insists on scrubbing every pore every day. I can assure you that other nations do not do so. Further, women do not cleanse every nook and cranny of their genitals each and every day, especially in these anti-douche days. Of course, regular cleansing under the skin which is held over the glans is necessary, but many men find that it need not be more frequent than every three or four days.

**4. Sex While Using the Skin-Expansion System.** The presence of tape on your penis can certainly present a real challenge in terms of spontaneous sexual activity. There are, however, different options with the various taping methods and procedures, and these will be indicated in the following chapters. Let me just say here that those who choose to wear the tape long-term, applied directly to the skin, have three options: For those whose skin will tolerate it, the tape can simply be removed as needed. For those whose skin is more tender, sexual activity must either be scheduled to coincide with your tape changes or you must become very familiar with the methods of 'early' tape removal discussed in the following section.

**5. Removing the Tape Before It Loosens Naturally.** For most men, there will be less irritation to the skin if the tape is allowed to loosen over time and removed only when the tape has begun to fall off naturally. But, males being males, most men will have times when they want to remove the tape before it has begun to loosen of its own accord. Several methods have been found: 1) soaking in a tub of hot water, 2) applying baby oil two or three times directly to the tape, and 3) several heavy latherings of soap in the shower.

## Solving Some Life-Style Problems

We are indeed creatures of habit, and some adjustments to our routines will no doubt be necessary. In this section I would like to

## Men's Voices...

In November 1990 I quit drinking alcohol, quit drugs, and decided to change my life for the better in all respects. I'm healthy now, exercise a lot, eat right, and sleep right. My physical, mental, spiritual, and financial well-being are improving every day.

In October 1991 I started foreskin restoration. It is all part of my being whole again and living the right way. Physical, spiritual, and mental wholeness—I feel better already. Thanks.”

C.R., New Mexico

“A month or so ago I wrote you explaining some of my case history and my extreme unhappiness about my being circumcised as an infant against my will. About the middle of October 1991 I started the skin-stretching technique. I have improvised a temporary method. I used two cloth band-aids vertically on my penis with a 3/8" half strip pulled across horizontally (I cut a little opening on the side of each strip). I take the 3/8" strip off every time I urinate. I was having trouble urinating with the tape on with two tight 3/4" strips. I take the 3/8" strip off and pull the glans forward and then push it back in after urinating. Removing the 3/8" strip often doesn't irritate the skin. I take the larger strips of tape off when I shower. I started off wearing the tape about eight hours a day the first two weeks; now I am up to 16 hours a day.

I have some questions. My glans gets smaller with the tape and skin over it, and I wonder how much good I am doing using this method? But the skin seems to be growing already and is becoming looser and is bunching up toward the glans now. I am very tightly circumcised and had no loose skin at all on my flaccid penis. Generally, how long will it take to cover my glans using this method? Since I've never looked closely at an intact penis, I don't know how much of my frenulum was cut off during the circumcision. I do have some skin connecting the glans for about one inch down to my shaft skin. This is by far the most sensitive part of my penis. My glans is a different kind of sensation; it's a nice feeling, but less satisfying and different than what's left of my

*(continued)*

## Men's Voices...

frenulum. I'd like to know how much was cut off. If I exercise or jog with the tape on, will there be any damage to the skin on my shaft? Is it a good idea to take the tape off while exercising? It seems to be a very good method.

My mental state is already much better now that I am finally trying to correct the damage done to me during this much unwanted and useless surgery. I still can't believe doctors can legally get away with cutting off the most sensitive part of a male's sex organ for absolutely no reason and not much is said or done about it. I'll not rest until a law is passed to stop the mutilation of male babies."

P.C., Nashville

"I really appreciate the support you are giving me during this. I anticipate the return of skin as well as the sensitivity (I never realized just how much I missed it), but I am not a patient person. Periodically, corresponding with someone who has succeeded will get me through this.

How much of the shaft skin can be pulled over the glans for taping? In other words, where on the shaft should the tape be placed? Does it matter? I can bury the glans in the shaft skin to completely cover it, although I can't pull enough remaining skin together to tape a ring distally. But won't that just stretch the skin far below the glans? Should I pull less skin forward to stretch that skin which is closest to the glans? For all of this effort, I would hate to be doing it wrong.

The majority of the medical community has traditionally circumcised their sons due to the misguided notion that these boys need to have this done. My colleagues seem to be the hardest to change; no one wants to admit that they made a mistake by unnecessarily amputating a functional part of the penis. Once that realization is made, then they will change. I know it's possible—Benjamin Spock changed his philosophy."

Physician

include a suggestion or two from other men who have used the skin-expansion system.

**1. Style of Underwear.** If you wear boxer shorts, you can skip this section. Boxer shorts are loose enough to accommodate any stage of the program. Many men, however, simply cannot or will not give up jockey shorts. For these men, two points of consideration will help. If you use a procedure which does not involve a weight, be sure your shorts fit loose enough to allow the taped penis to hang relatively free. If you use one of the 'weighted' procedures, you can cut a hole in the front of the briefs such that the weight and the tip of the penis hang free. As strange as this idea may sound to some of you, many men prefer to wear jockey shorts with a hole cut in the pouch rather than switch to boxers. The important point is to be sure that the penis is not compressed by your underwear so that there is enough freedom for the needed tension to be exerted on the penile skin.

**2. Getting Used to 'Pressure' on Your Penis.** Some men describe the feeling as, 'having your penis stuffed back inside your body.' Actually, most men in a very short time become so accustomed to the feelings of the slight tension, the tape, and the devices that they often forget they are wearing anything on their penis. Many men report that they sometimes have to discreetly feel to remind themselves what they are wearing before they go into a public rest room.

On the other hand, some men simply never get used to the feeling of having their glans restrained back inside the shaft covering. For these men, the weighted procedures are often more comfortable. In any stage, the weighted procedure pulls the skin slightly out away from the glans enough to help relieve the direct pressure on the glans.

**3. The Question of Wearing Tape in Public.** We will look in detail in the next three chapters at the various taping options. At this point, it is enough to say that some men find that their skin is so tender that they simply cannot repeatedly remove the tape from their penis. Once these men apply tape directly to their skin, typically, it must stay there until it begins to loosen naturally. Some of these men also live life styles which include jogging, working out at the gym, golf, etc. For some, this has always meant showering and dressing in public, often with a group of friends or acquaintances. A decision which these men must make is whether or not to 'go public' with their restoration program. I have a friend in San Francisco who regularly goes to the gym with his penis taped and takes the opportunity to discuss his feelings about circumcision with anyone who cares to comment! Others will not be so brave and will need to schedule their visits to the gym much as they schedule their sexual activities to coincide with tape removal and replacement.

## Advantages of the Skin-Expansion System of Foreskin Restoration

There are, indeed, a few very obvious advantages to the skin-expansion system of restoration.

**1. Cost.** No doubt one of the most popular features of the skin-expansion system is the low cost involved. The combined cost of this book, innumerable rolls of tape, a few miscellaneous supplies (up to and including one of the manufactured devices discussed in Chapter 18), and periodic medical consultation is a very modest sum when compared to the simplest surgical procedure. Many men opt for a skin-expansion program simply because it is the only means of restoration they can afford.

**2. No Surgical Risks.** Many men want to avoid any further surgery to their penis. Others would undergo surgery if they felt assured that it could be done 'risk free.' Such a guarantee is not possible. Human tissue cannot be surgically invaded without a certain element of risk. We will look more closely at this fact when we discuss surgical trends in Chapter 20. It should be noted here, however, that many men are simply not prepared to take surgical risks with their penis and prefer the gentler, more easily controlled dynamics of skin expansion.

**3. Relative Privacy.** Even if you include a doctor's involvement as a regular part of your program, the number of people who *need* to be aware that you are involved in such an endeavor is relatively small. While it is comparatively difficult to conceal the hospital stays and time off work needed for surgical reconstruction, the nonsurgical skin-expansion system is relatively private. For some men this factor is an important consideration.

**4. Availability.** Due to the current lack of doctors willing or skilled to do surgical reconstruction procedures, the interested individual may be required to do extensive phoning and traveling to various parts of the country (or world) in order to obtain a surgical reconstruction. On the other hand, a drugstore which stocks an array of tape and a variety of scissors is, in all probability, right around the corner.

## Disadvantages of the Skin-Expansion System of Restoration

There are, to be sure, some real disadvantages to the skin-expansion procedures.

**1. Trial and Error.** Many men who contact UNCIRC would like a tidy, precise procedure that is uniform for all individuals and physiological conditions. Nonsurgical skin-expansion procedures of foreskin restoration are simply not at that stage of development. There

### Men's Voices...

"I recognized when I started school that there were two kinds of penises, but didn't know how to ask for a long time. In fact, while I'm circumcised, I thought maybe the other guys had had the glans removed and that's why they had tapering organs! In 7th grade gym class somebody finally told me about it. A year or so later, I asked my father what circumcision meant as if I didn't know, to see what he'd say. He told me I didn't have to worry, that I was. He didn't tell me he wasn't, although I'd seen him when he changed at swimming pools and a few times at home. I wanted to ask why it was done to me, and what the difference was in how each kind worked, but I couldn't. As hard a time as they had in the depression—I was born in 1934—I'm sure it was an extra expense, and they were only doing what they thought best. So I don't blame them, and I don't dwell on it that much. But from the time I knew the difference, I felt I had something missing. And as the years went by, I wished I hadn't been.

Now I've begun taping. I don't think I'd resort to surgery unless I needed to tighten up the end of my foreskin—if I ever get that far."

C.O., Tennessee

"It's amazing how recovering that simple flap of skin over the head of my penis has done more for my self-esteem and body image than years of therapy could ever have accomplished!

While having a routine physical exam, my new doctor pushed back the foreskin to expose my glans, and then rolled it forward again. He then made a notation in my chart that said, 'uncircumcised.' I was surprised but elated—my foreskin passed for natural in the eyes of a physician!

The restoration of my foreskin has been, by far, the best thing I have ever done for myself."

C.L., Idaho

"I appreciated meeting you and hearing your presentation on foreskin restoration at the Second International Symposium on Circumcision in San Francisco two weeks ago. I am very impressed by your work.

(continued)

### Men's Voices...

As we discussed after your talk I would appreciate copies of your slides on the taping and stretching the foreskin and on the foreskin surgical reconstruction. They would be a big help to me in my efforts to reduce or eliminate the practice of circumcision at the hospital where I practice."

Physician

may come a day when doctors will be so aware of these procedures and of individual anatomical features that a single physical examination will be enough to chart a sure-fire course of action for any man seeking to restore his foreskin by such means. That day may come, but it is not here now. Today, interested men must try a variety of tapes, different methods of the taping, various schedules of taping, etc., in order to discover a program best suited for their individual needs. These recurring discovery periods can be very frustrating.

**2. Time and Patience.** I know of no other feature of this system which gets as much comment from men who have somehow managed through the various trial-and-error phases of their programs. Even when you know you're doing it all correctly, IT SEEMS TO TAKE FOREVER! Efforts to push the process faster often result in setbacks. There are no means, known so far, to make the process go faster.

It is true, thus far, that nothing moves this process along except persistence and dedication. We will discuss, however, in Chapter 21, the possible effects of testosterone ointment applied to penile skin, combined with expansion techniques, when we discuss various 'co-operative' procedures suggested by Dr. Michael Scott and others.

**3. The System Is Not Appropriate for Everyone.** In Chapter 8, I discussed the case of a 24-year-old male who has hair growing thickly on his penis out to his circumcision scar. Such a condition, and perhaps others as well, would suggest that some men are not particularly good candidates for the rather simple skin-expansion system discussed in these chapters. In order to accomplish satisfactory results from such techniques, a male should have a fairly standard, American-style, circumcised penis. If such is not the case, surgery may be the only viable course of action. Hopefully, willing doctors across the nation will soon be identified so that males who are in doubt as to the most advisable restoration techniques for their particular needs can seek and find easier access to medical assistance.

### Most Frequently Asked Questions

Some questions recur with a high degree of regularity:

***1. Will this procedure make my penis permanently shorter?***

This question is usually triggered by the fact that the taping methods and procedures tend to push the body of the penis back inside the penile sheath. It is, in fact, the tension created by the penile body 'pushing back' against the tape entrapment which causes the skin to expand. Nonetheless, seeing a rather severely foreshortened penis after the tape has been applied has been enough to frighten some men from continuing the program. I am assured both by doctors and by men who have completed their program that there are no permanent effects, other than the skin expansion itself, on the size or structure of the penis. Furthermore, a few erections without the tape in place are

usually all most men need to be reassured that their erected penis is the same size as always.

## ***2. How long does 'stretching' take?***

If I could answer this question for an individual at the outset of his program, I might well turn such predictions into a cash endeavor. Such physiological and anatomical features as how much mobile shaft skin was left on the penis, the relative size of the penile shaft as compared to the glans, the ease with which the individual's skin expands, etc., all combine to determine an individual's potential rate of progress. Then, one must take into account such unknowns as how persistent and methodical a given individual will be during his program. And finally, what are the finished results desired by the particular individual? How much 'foreskin' does he want? With these factors in mind, an individual's expected rate of progress to his particular goal is anyone's guess. The shortest program 'on record' is four months. After four months, the individual simply stated that he now had gained what he wanted, and declared himself finished. Others have been stretching for four and five years and still do not have their glans fully covered when the tape is removed, even when flaccid. The individual who sets out to regain his foreskin by expanding the penile shaft has begun a journey of unknown duration!

While no reliable estimate of the overall time frame of a skin-expansion program is possible for any particular individual, the photos (Figures 13-1 through 13-3) illustrating progress are typical.

## ***3. Do I have to wear the tape all the time?***

No one really knows the *exact* effects of not wearing the tape regularly or to what extent the skin is allowed to 'recoup' when not under tension. It is known that the natural elasticity of the skin must be overcome over an extended period of time, much like the skin of an individual who is obese for a long time. It is also believed, with some evidence, that men who are persistent and wear the tape continuously do indeed have quicker and more obvious results than those who wear the tape spasmodically.

## ***4. When will I see or feel results?***

Often, men *feel* results before they *see* them. That is, after the glans has been regularly covered, often for only a few weeks, there is a noticeable change in sensitivity. Further, the texture of the glans often changes becoming more tender and moist. These changes frequently occur long before there is enough additional skin developed to keep the glans even partially covered without tape. Furthermore, the flaccid penis typically changes in volume frequently during the course of a day, from shriveled after a cold shower, to elongated due to warmth or while urinating, to further extended during slight sexual arousal. In the course of such changes, one instance you see

results, and the next you don't. It is, therefore, only the long-term, more permanent results which really count. And these more consistent results take time.

### ***5. Will I get stretch marks?***

Some men do—as women do during pregnancy. One difference, however, is significant. The male stretching his foreskin can modify the amount of tension he is exerting during any period of his program. The wisest course of action, should stretch marks begin to appear, is to reduce the tension until the actual skin expansion catches up. In the meantime, if stretch marks have already appeared, many men find that applying cocoa butter or other skin softeners often helps.

## **Keeping Track of Your Progress**

Being assured that you are making progress is a very important feature of the skin-expansion system. The absolute quantity of skin is the best evidence you can have that the program is working. Many men find it reassuring to take occasional measurements of the penile skin in order to track their progress.

One very simple method of measurement is to cut a narrow strip of tape 7-10 inches long. This tape strip is to be applied to the skin while the skin is being stretched. During an erection, gently press one end of the tape onto the shaft skin just behind the glans. Stretch the skin backward by pushing the slack skin back against the abdomen and gently apply the tape lengthwise along the top of the penis toward the hairline. As the tape approaches the bunched-up skin you have pushed back, release the skin and stretch it in the other direction, out over the glans. Continue gently applying the tape to the stretched skin until the tape reaches the hairline. Mark the tape at the point where it contacts the hairline. You should designate a particular spot at the hairline so that you can always mark the tape at the same spot. Gently remove the tape from your penis. Lay the tape along the edge of a ruler. This procedure will give you a measurement of the actual stretched-skin surface of the penis from the corona of the glans to the hairline. By taking such a measurement periodically, you can more precisely monitor your progress.

## **Partner Support**

Partner support is an important issue for any circumcised man in a committed relationship who seeks foreskin restoration by any means. But, it must be recognized that the time factor involved in restoration by skin expansion poses additional strain on a relationship.

**1. Why Would He Want To?** Many women, just as many males, in our culture are simply unaware that some circumcised men have strong negative feelings about being circumcised. If at all possible, it is worth investing the time and consideration to educate and inform your partner about circumcision in general and your own feelings in

particular. Many men who respond to the UNCIRC questionnaire note that their wife or partner simply does not understand why regaining his foreskin is so important to him. In such instances, you'll only get the support you need when a point of mutual understanding has been reached.

Just as it was suggested earlier that you use the material in this book to inform your doctor if he is unaware of this program, it may be helpful to share at least portions of this book with your partner. I suggest that, when you find particular sections in the book which help you clarify and understand some of your own thoughts and feelings, you share these with your partner. The knowledge that other men feel as you do and are doing something positive to help themselves may help your partner to better understand your desire to regain both your foreskin and a sense of wholeness.

**2. Feelings of Rejection.** If a man suddenly begins to skip spontaneous sex because his penis is taped, his partner may take it rather personally. It is important that the circumcised male reassure and inform his partner as to the depth of feelings and desires involved in his intention to embark on a restoration program so that the partner can understand the full significance of what regaining his foreskin means to him.

**3. Uncomfortable Role Reversal in Marriage.** We're still old-fashioned enough in this country that many wives are uncomfortable having to deal openly with a husband's pain, vulnerability, and woundedness. She may have always expected him to be 'the strong one,' often 'the strong, silent one.' Now, she may be called upon to stand by him in ways which have not been, to date, typical in their relationship. More than one wife has suggested the need for a support group to support the wives who are supporting their restoring husband! What havoc circumcision has wrought in the name of health.

**4. A Note to Married Men.** Helping your wife to understand your feelings and needs is vital to gaining her support. While it may be true that it is *your* penis, it is also true that *your* sex life is a shared experience between *two* people. The very basis of a committed relationship in marriage is that we grant our spouse access to our body. If you, then, as a circumcised male, feel the need to modify the rules of access and availability, it can be destructive to the relationship unless it can be a shared decision made in love and understanding. Take time to explain your feelings and actions and to answer questions. You have no doubt been without your foreskin for most of your life; a few more days or weeks is a wise investment in both your restoration program and your relationship.

In the next three chapters we will consider the various taping methods, procedures, and devices used during the three stages of the skin-expansion system of foreskin restoration.

# 15

## The Skin-Expansion System Stage I— The Tape Strap

*"I thought at first that this would never work, but over the past five weeks the skin has indeed started stretching and has loosened up quite a bit."*

**L.R., Boston**

**NOTE: This chapter is presented here as in the original publication. In 1992 this information was the most current thinking about foreskin restoration. Since that time, a number of additional methods and devices have become generally available. For more current information, see the National Organization of Resorting Men [www.norm.org](http://www.norm.org).**

### Men's Voices...

"My wife, who is a nurse, upon seeing the weight hanging from my penis said jokingly, 'You know, my mom said when we were kids, that we should always wear clean underwear just in case we had to go to the hospital emergency room. Maybe you should wear a sign on that contraption that says, Do not remove. Restoration in progress.'"

J.L., Salt Lake City

"I was circumcised at around one year of age. I have an extremely good memory. The pain that I experienced until I reached puberty was excruciating. I suppose that sexual development actually further de-sensitized me but it still was a great relief. I still somehow remember my intact state. My father even suggested several times to pull what foreskin I had left over my glans to keep me from climbing the walls. It really was that bad. My father was circumcised.

I began to stretch my foreskin when I was in college. I had very few people to talk to about this. I normally wear bikini underwear and have pulled my foreskin forward enough that the glans is completely covered. The underwear holds me in. No friction, no pain. It's worked well for years. The original information contained all of the BUFF

*(continued)*

A large percentage of American males have been circumcised very tightly with little or no mobile shaft skin left on their penis. Initially, these men cannot pull enough shaft skin forward to completely cover the glans. The tape-strap procedures presented in this chapter allow such men to begin their restoration program by partially covering the glans until sufficient coverage has been achieved to move on to the next stage of the system. The important fact to remember is that tension on the shaft skin is the operative factor. This gentle tension needed to expand the skin can be achieved regardless of the stage of the program at which you are working.

There are three *basic taping methods* in each stage of the system. Each individual must determine the method best suited to his particular skin and anatomy. Further, there are three different *procedures* in each stage. Again, the individual must discover which procedure is best suited to him in terms of the taping method he has chosen, his comfort while using the procedure, and his life style.

### Three Basic Taping Methods

The three basic taping methods follow the same principles in each stage of the system. They are: 1) tape on-and-off the skin, 2) tape worn long-term on the skin, and 3) tape on-and-off a skin guard.

**1. On-and-Off the Skin.** This is the simplest of the taping methods in terms of application and maintenance. It is used by those men whose skin is resilient enough to allow them to find a tape which they can apply, remove, and reapply as needed with minimal discom-



fort and virtually no skin reaction. If your skin will tolerate this method, you simply remove the tape as needed for urinating, showering, sex, and perhaps even sleeping at first.

**2. Long-Term Wear on the Skin.** Some men prefer to put the tape in place on their skin and leave it there until it loosens and begins to fall off naturally, usually within two to four days. In order to use this method of taping, a means must be provided for urinating through or around the tape (or device in the later stages of the system).

**3. On-and-Off a Skin Guard.** For those men who want to remove the tape at will but whose skin is too tender or sensitive to allow the repeated removal and reapplication of tape, there is a solution. This taping method combines the best features of the two methods described above. First, a ‘layer’ of tape is applied directly to the skin—the skin guard. This guard remains in place on the skin until the tape loosens and begins to fall off naturally. Next, a second tape is applied directly to (on top of) the skin guard such that it does not touch the skin at any point. This second tape is removed and reapplied as often as needed with no discomfort or damage to the skin.

### Three Basic Tape-Strap Procedures

There are three basic procedures in each stage of the system: 1) nonrestricted, 2) extended wear, and 3) weighted. The first two procedures, nonrestricted and extended wear, rely on the ‘push’ or pressure from the entrapped penile body to provide the needed tension for skin expansion to occur. The weighted procedure, however, further benefits from the added tension of the ‘pull’ of a weight device. In this chapter, each of the tape-strap procedures will be outlined and illustrated. We will also look at some of the factors which may help you determine the best procedure for you. Don’t be afraid to experiment with the various options until you find the procedure which best fits your anatomical and physiological needs and your life style.

### Nonrestricted Procedure

This procedure is so named because there are no restrictions as to when or how often the tape or device can be removed and reapplied. This is the simplest of the tape-strap procedures. The strap is removed as needed for urinating, showering, sex, and perhaps even sleep at first. There are, however, two quite different versions of this procedure depending on whether you apply the tape strap directly to your skin or to a tape guard.

### Men’s Voices...

material. I have read the information many times and have followed the regimen for almost six months at a time. But I have not been consistent.

I have an active sex life, sometimes a frequency of two or three times a day. Taping has become convenient—we are fairly spontaneous. I have found out something, though. I am presently inserting cotton balls in the resultant foreskin. This does two rather interesting things: My glans remains moist and much more sensitive, and the foreskin seems to have more tension and therefore has given me even more coverage. Better results.

I have had results. Well enough to report that I have some coverage when flaccid and can partially cover my glans when erect. Most of the sensitivity that I lost has returned to the point that I cannot take ‘rubbing’ which now rarely happens. In the shower, I often ‘gently’ pull my foreskin forward to stretch it further. I wait around 15 seconds and then release. I also do this after I urinate. Again, to fit myself into underwear if I am not using the tape method at the time. Even though I have not had a consistent program, I have had results. Perhaps the Stage 3 information will be helpful. I know that eventually I will have to have some type of ‘closure’ procedure. Better than the surgery that I had originally considered. Where do I go from here? I would like to maximize my results in the shortest time possible. I have also enough coverage to be happy with my efforts. Slightly more would be great.”

L.W., Mississippi

“Funny, I never, not as a kid, youth, young man or mature adult, missed not having a foreskin until one day I read an article, an anti-circumcision piece, and experienced a vague sort of regret that I didn’t have my foreskin. I’ve never felt any resentment towards my parents...they only did what they thought best...and almost all kids of my age and social status (white, protestant, middle class, born before WW II) were routinely cut...it was rare to ever see anybody who wasn’t.

Anyway, one day I saw an article about foreskin replacement, most of which was about surgical replacement, which I would never consider for a

*(continued on page 158)*

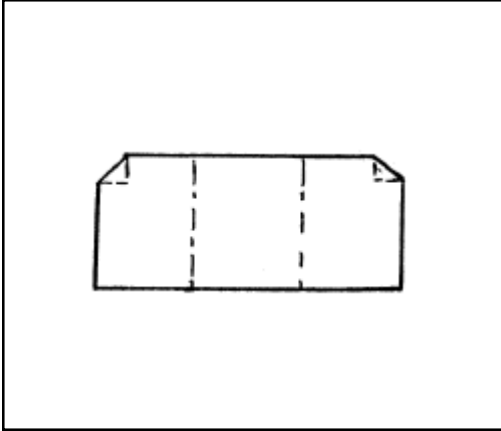

Figure 15-1 Tape strap with turned corners

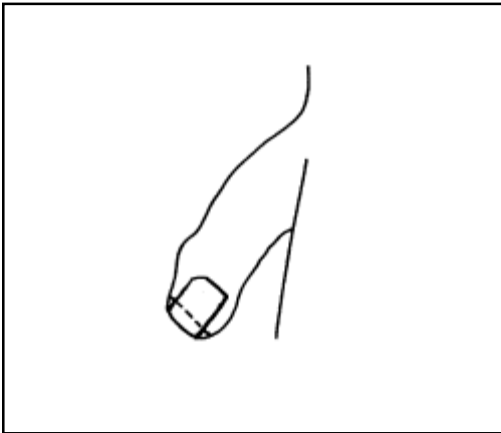

Figure 15-2 Single tape strap

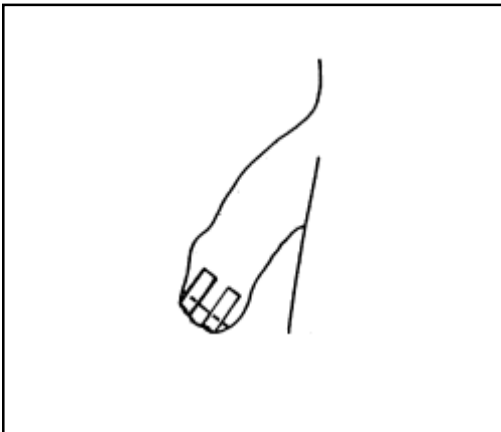

Figure 15-3 Double straps

### The Tape-on-Skin Version

Those men who are able to use the on-and-off-the-skin taping method will find this version of the nonrestricted procedure extremely simple.

**1. Constructing the Tape Strap.** After you have chosen the appropriate tape width for your needs (see Chapter 14), cut a piece of tape 2-3 inches in length. Remember, you want enough tape on your skin to provide a firm hold but with as much shaft skin exposed as possible to allow for expansion. Now, apply another square of tape, face-to-face, in the center of the original 2-3 inch piece. At this point, the strap will resemble a Band-Aid. The nonadhesive square in the center of the strap is to be positioned so as to prevent the strap from sticking to the glans. Some men prefer to simply put a dab of talc where the strap contacts the glans, but the precaution of a tape square seems more foolproof. It is important, by one means or another, not to let the tape stick to the glans, as removal will be painful and could cause damage. Before you apply any tape strap which you will be removing regularly, always turn a small tab at the corners for easy removal (Figure 15-1).

**2. Applying a Single Strap.** After constructing a simple, straight strap as detailed above, pull the skin forward over the glans as far as it will go *without pain*. Apply one end of the strap to the skin which is over the glans on one side of the penis. Next, position the nonadhesive center over the tip of the glans and apply the other end of the strap to the skin which is covering the other side of the glans. Some men find that they are more comfortable wearing the strap from top to bottom and others find that alternating the position of the strap helps the skin to better tolerate the regular removal and replacement of the tape. This taping configuration seems especially suited for men whose glans is relatively large as compared to the circumference of the shaft skin (Figure 15-2).

**3. Double Straps.** Some men discover that two narrower straps worn side by side allow the tape to conform better to the contour of their glans. As noted above, the straps can be worn from side to side or top to bottom. This double-strap configuration is especially suited for men whose glans is relatively small as compared to the circumference of the shaft skin. As with the single strap, pull the skin forward over the glans as far as it will go without pain, and apply the straps as outlined above (Figure 15-3).

**4. Crossed Straps.** When you have enough skin to nearly cover the glans, this configuration allows the orifice of the developing foreskin to be more nearly closed. Simply apply one strap from side to side and the other from top to bottom. This style of taping typically enhances the recovery of the sensitivity of the glans (Figure 15-4).

### The Skin-Guard Version

The skin-guard taping method allows the individual with sensitive skin to use the nonrestricted and weighted procedures without discomfort or damage to the skin. This taping method typically requires some trial-and-error experimentation, but many men find it well worth the effort. First, two squares of tape are applied directly to the skin—one on either side of your penis. These two squares of tape form ‘skin guards’ which remain in place on the skin until they begin to loosen and fall off naturally. After the skin guards have been positioned on the shaft skin, the tape strap is applied such that the adhesive surfaces of the strap adhere to the skin guards rather than the skin itself. For urinating or bathing, the strap is removed while the skin guards remain in place on the skin.

#### 1. Applying the Skin Guards.

- 1) Cut two squares of tape—the skin guards—slightly larger than the ends of the tape strap you are going to apply.
- 2) Pull the shaft skin forward onto the glans to the appropriate position for taping.
- 3) Using a nontoxic fine point felt-tip or ball-point pen, lightly mark the spot on either side (or the top and underside) of the penis where the ends of the tape strap are to be applied.
- 4) Release the skin and apply the two guards to the shaft skin at the marked positions (Figure 15-5).

Note: With a little practice, this taping method can be adapted for use with any of the strap configurations described earlier in this chapter.

**2. Applying the Strap.** Pull the skin back onto the glans, and apply first one end of the tape strap(s) and then the other. Again, always turn a corner tab for easy removal (Figure 15-6).

**3. Sex with the Tape Guards in Place.** Some men report that, by using a condom, they are able to have sexual intercourse with the tape guards in place on their penis. After sex and a quick shower, they simply use a hair dryer to dry the guards as quickly as possible and reapply the strap(s).

### Extended-Wear Procedure

Some men prefer to apply the tape strap(s) and leave it in place on their skin until it loosens and falls off naturally. In order to use this procedure, a means must be provided for urinating through or around the strap(s). There are three alternate configurations in which to apply the tape for extended wear.

**1. The Single Strap.** To wear the single strap continuously, simply construct the strap as described above and use a paper punch

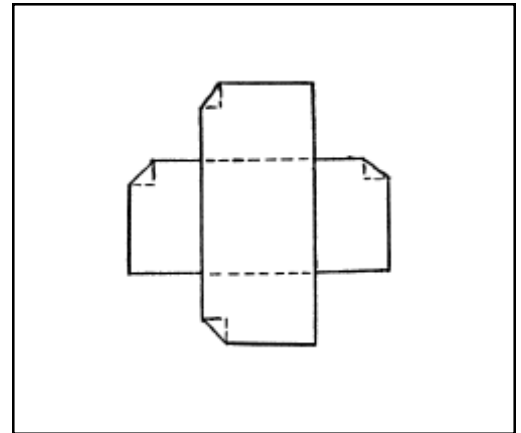

Figure 15-4 Crossed straps

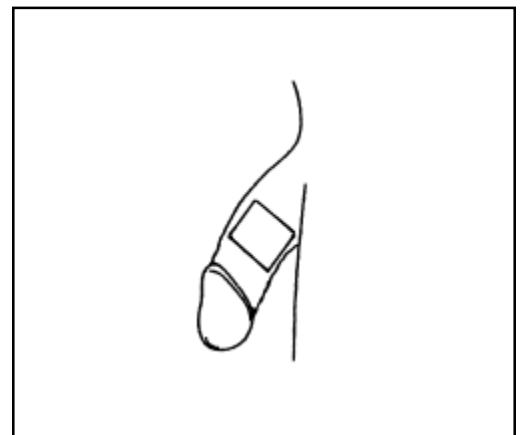

Figure 15-5 Two guards on the penis

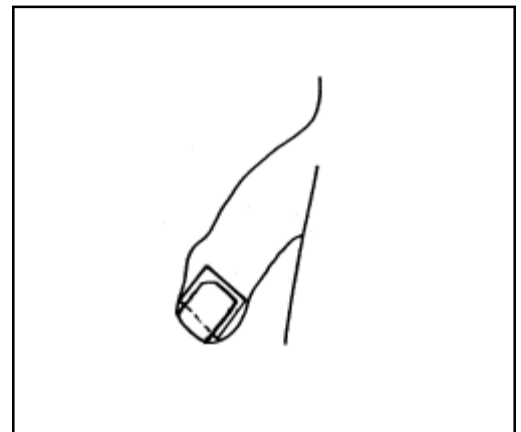

Figure 15-6 Strap on guards

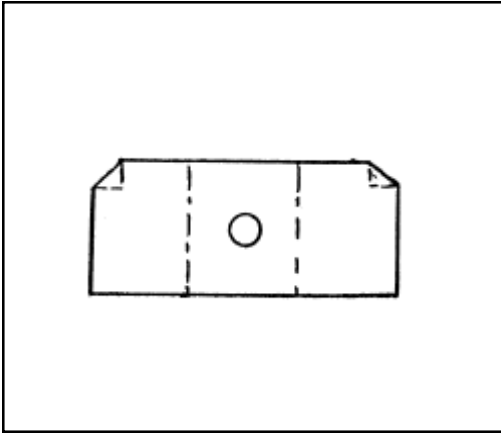

Figure 15-7 Single strap with hole

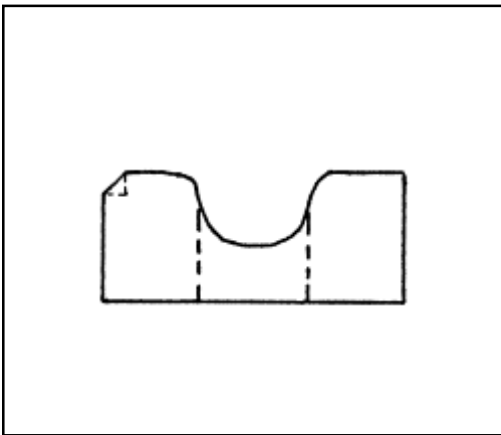

Figure 15-8 Butterfly strap

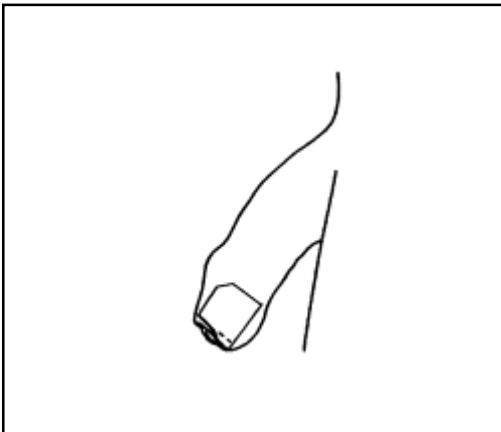

Figure 15-9 Applied butterfly strap

to make a hole near the center of the strap which will be the appropriate shape and size to allow you to urinate through the strap (Figure 15-7).

**2. Double Straps.** The double-strap configuration is very adaptable for continuous wear, since the straps can always be applied—top to bottom or side to side—in such a way as to leave the urethra clear for urinating (Figure 15-3).

**3. The Butterfly Strap.** This strap is made using 1-inch tape. As described above, place a square of tape, face-to-face, in the center of a 2-3 inch piece of tape. With scissors, trim out up to one half of the width of the tape to accommodate urination (Figure 15-8).

Place the butterfly strap from side to side on the penis with the trimmed side either up or down, whichever best clears the urethra for urinating. Many men find this strap particularly suitable due to their individual anatomical features and because it allows ease of urination while providing relatively large adhesive surfaces on the skin (Figure 15-9).

**4. Crossed Straps.** Again, this configuration allows the orifice of the skin to be more nearly closed. As with the straight strap, a hole must be punched near the center of the straps for urinating (Figure 15-10).

### Weighted Tape-Strap Procedure

This procedure provides additional tension by use of a weight device. The procedure has two basic advantages: 1) The weight device places additional tension on the shaft skin. 2) Some men are more comfortable when there is less pressure exerted directly on the glans. This strap is removed each time for urinating, bathing, and sleeping.

**1. Materials.** You will need: 1) a roll of 1-inch tape, 2) a piece of lightweight plastic such as a name tag cover or flexible plastic wallet calendar, 3) a small snap, or snap swivel, used in making fishing rigs, 4) clear, 20 lb. monofilament (or other heavy-duty string or cord), 5) a needle large enough to accommodate the monofilament and to pierce the plastic, and 6) a smooth, 2-ounce lead fishing sinker with a loop. Heavier weights are not recommended since the tape tends to loosen or migrate if too much tension is applied to it. Furthermore, the bulk of the entrapped penis combined with the added 2 ounces of weight will typically provide ample tension to expand the skin at this stage. (Note: The lead sinker should be covered with tape to prevent lead-skin contact.)

### 2. How to Assemble the Weighted Strap.

1) Cut an oval or circle out of the lightweight plastic, 1 inch in diameter. This becomes the shield which restrains the glans and to which the weight is attached.

- 2) Using the needle threaded with a 10-inch piece of monofilament, draw the monofilament through the shield near its center and then back through the shield again. Leave enough space between the two holes so that the monofilament will not tear through the shield.
- 3) Tie the small snap securely to the underside of the shield (Figure 15-11).
- 4) Cut a 2-3 inch piece of 1-inch tape to form the strap, and punch a hole in the center.
- 5) ‘Thread’ the snap which is attached to the shield through the hole in the strap, from the adhesive side of the tape, and fix the shield firmly in place in the center of the strap.
- 6) In order to provide a smooth surface for the tip of the glans to rest against, place a square of Microfoam surgical tape over the shield such that the shield is laminated between the strap and the added square of foam tape (Figure 15-12).

**3. How to Apply the Weighted Strap.** The weighted strap can be worn using either of the on-and-off taping methods (applied directly to the skin or using a skin guard). Whichever method you choose, apply the strap as follows:

- 1) Pull the skin forward onto the glans, and apply first one end of the strap and then the other. Be sure to turn a corner tab for easy removal.
- 2) After the strap is in place on your penis, attach the 2-ounce sinker by means of the snap (Figure 15-13).

The weighted tape-strap procedure may seem a bit complicated at first, but men who have used it report that it is comfortable to wear and that it provides results more quickly.

**4. Caution.** It is never recommended that any weight device which is used in any stage of the skin-expansion system be worn during sleep. Nocturnal erections and the possibility of bruising the glans or other parts of the genitalia make nighttime wear inadvisable. Nocturnal erections combined with a simple tape strap will provide ample tension for the ongoing skin-expansion process at this stage of the system.

### Learning to Apply the Tape

Regardless of the taping method or configuration you choose, a little trial-and-error practice will no doubt be needed in order to achieve satisfying results. Don’t expect the results of taping to be neat and tidy the first few times you apply the tape. Just leave the crooked job alone until the next time, unless the results cause pain! You will be surprised and pleased how soon the taping process will become routine and the results neat and uniform.

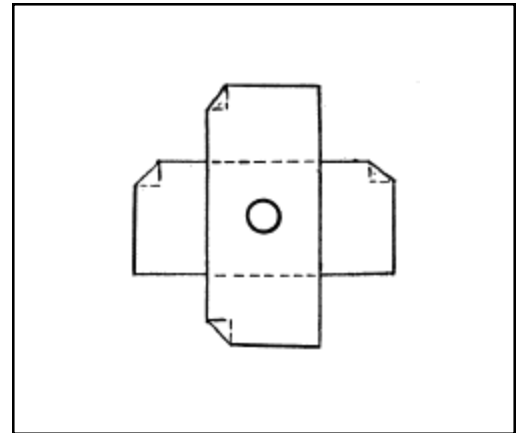

Figure 15-10 Crossed straps with hole

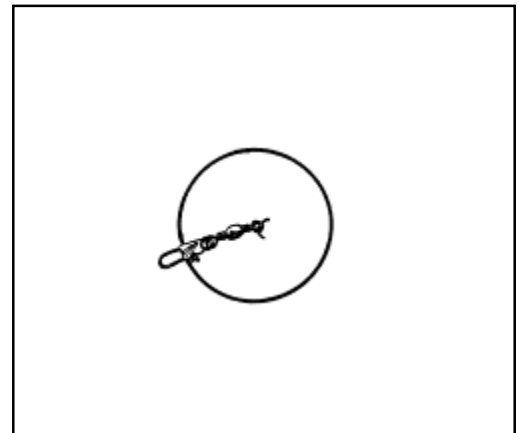

Figure 15-11 Snap attached to shield

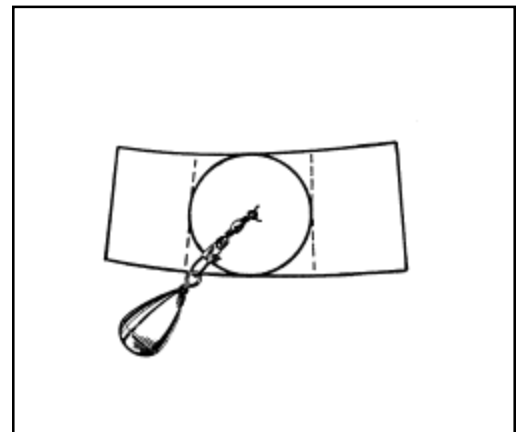

Figure 15-12 Assembled tape strap

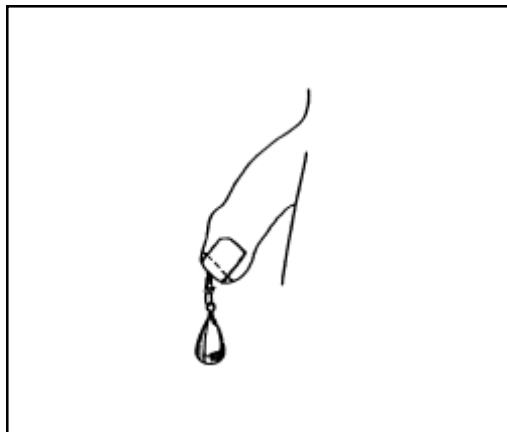

Figure 15-13 Weight attached to strap on penis

### Men's Voices...

number of a reasons.

I have been using the stretching tape (from one side to the other) faithfully and see some evidence that I am growing more skin, which will comfortably cover 2/3 to 3/4 of the head when the tape strap is in place. However, I have not yet reached the stage where the skin will stay forward when the tape is off. I have learned to check the placement of the strap before urinating so have had no more unpleasant squirting surprises. I have also become quite adept at pulling on a new strap, but it is still a pain to cut the two pieces of tape, place them face-to-face, then cut the hole before pulling the skin forward and sticking the tape in place. I'd say that on the average, I have had the strap in place more than 23 hours per day. And sometimes I am able to wear it through two or even three showers before removing it in the interests of cleanliness. Then, other times it will come loose of its own accord, or I will gently pull it off under the hot spray.

I have had a couple of unfortunate accidents, though. Once I didn't get the strap properly placed and tried to pull it off dry, which resulted in the removal of a little patch of skin on either side of the shaft and some bleeding. I guess I pulled

*(continued)*

Many circumcised men have very little mobility of the skin on the shaft of their penis. Because there is so little shaft skin remaining, these men are not accustomed to moving the penile covering very far from its stationary position. This is not the way natural penile covering functions. An intact male typically will be able to move the skin virtually from one end of his penis to the other, limited only by the length of the stretched-out frenulum. For many circumcised males, therefore, it is both the expansion of the penile skin and a renewed mobility which are accomplished by the skin-expansion system. Before a greater degree of mobility is regained, however, you may have some trouble getting the shaft skin up and onto, or over, the glans. Many men find it helpful to soak in a bath of warm or hot water in order to make the penile skin more supple. With time, the skin will not require such softening in order to be pulled into position for taping.

### Initial Joys of Stage I

This book is entitled THE JOY OF UNCIRCUMCISING!; it seems, therefore, appropriate to talk about some of the more immediate pleasures experienced by men who begin the skin-expansion system.

**1. The Glans Partially Covered.** Depending upon the amount of mobile shaft skin you have to work with, a tape strap in place on your penis means that anywhere from a quarter to all of your glans is covered by skin—probably for the first time in your life. This fact means that the process has already begun by which the glans will regain heightened sensitivity.

**2. 'Normalized' Mucous Tissue.** Again, depending on the style of your circumcision, the tissue between the corona of the glans and the circumcision scar is mucous tissue. It is this area, just behind the glans, which is being held next to the glans during taping. And this tissue, typically, also will begin to soften and to regain many features of natural mucous tissue. The heightened sensitivity of this tissue, along with that of the glans itself, is a very real payoff early in this stage of the system.

**3. The Glans Feels 'At Home.'** Many men report that from the very first time they applied the tape, their glans felt warm and sheltered, as nature intended. These men are often 'hooked' on the restoration program from that moment on. They say that they cannot imagine having their glans exposed again and not enjoying that 'at home' feeling they've discovered.

## More Joys of Stage I

While some joys are immediate, others develop over time.

**1. Enhanced Sensitivity.** In the later phases of Stage I, your glans will be almost entirely covered with skin 24 hours a day. At that point both your glans and the mucous tissue will no doubt have developed a degree of sensitivity which you as a circumcised male may not have imagined possible. Some men actually sense a warmth or ‘glow’ they have never before known, particularly at times of sexual arousal.

**2. Mobility of the Shaft Skin.** The very fact of greater mobility or ‘travel’ of the penile covering on the shaft of the penis is both a novelty and a source of pleasure, particularly during foreplay. For the first time in their life, many circumcised males can move the skin along the entire length of their penis. For the first time in their life, many circumcised males can stroke the skin, their fledgling foreskin, out onto and over the glans. For men who have never known these sensations, the joys of these developments are often incredible.

## How Long Does Stage I Take?

As I noted in Chapter 14, questions about time nearly always come up. And there are no uniform answers. Such factors as the initial amount of shaft skin, the initial mobility of the shaft skin, and the ease with which an individual’s skin expands are all significant factors. I am acquainted with one individual who was very tightly circumcised, whose skin does not seem to expand as easily as some, and who wore a tape strap day and night during the first stage of his program. He was ready to move on to Stage II after 15 months of using a tape-strap procedure. I believe it is fair to say that the majority of men probably do not need to tape with a tape strap that long before moving on to Stage II.

## The Goal of Stage I

The completion of Stage I is reached at the point where you no longer feel the appropriate tension on your skin while you are wearing a tape strap. At that point, you will have a basic decision to make: either to continue the skin-expansion system or to stop and enjoy your achievements.

**1. Stopping Here.** There are those men who have been circumcised so tightly that slack, mobile shaft skin and comfortable erections are enough for them. And, if that is their goal, there is no reason that they should not stop at this point and enjoy their accomplishment. After all, as circumcised males, we have had enough of others thinking they knew best and making decisions about our penis! So, if you want to stop here, do so and enjoy!

## Men’s Voices...

a bit too hard and fast, for I have since been able to reposition tape without any problem. Then, I did it again yesterday, even though the removal was slow and gentle; this time only on one side and with almost no bleeding. The first time I just switched to a top-to-bottom tape until the sides healed. Today, I am going without, but if healing isn’t complete enough to put the tape back by tonight, I’ll use top-to-bottom for a couple of days. Have you ever experienced this problem? Do you have any recommendations? My other problem is that when I think about taping, if I am not quick in putting the strap in place, things swell up and I have to abandon the effort, and turn my thought to other things for a bit before I can try again. I’ve been stretching for about 1 1/2 months now and can’t wait until I get to where I can pull the skin forward far enough to completely cover the head and strap it in place that way. I’ve been using Micropore tape, which causes no irritation. Hair, however, has been a problem and I have to keep it cut short and, on the sides of the shaft itself where the tape will go, plucked out. All in all, it is a lot of trouble and I can see why you said it takes commitment—a commitment I believe I have. I can hardly wait!”

N.I., Flagstaff

“I was raised in Australia and all boys were circumcised at that time. I did not even realize that there was such a process done until I was a teenager. The first time I even knew there was a difference (and I might add most of the kids in class) was when a group of us went to the locker room and ran into one of our teachers (teachers used the locker rooms at certain periods of the day) who had just left the showers and had what we later found out was foreskin—we all thought it grew that way as you got older. I suppose we were about 11 or 12 years old. Circumcision is not in the top ten topics of discussion. It seemed to me that when you were born you were circumcised, and that was the end of the subject. I never raised the question with either of my parents.

*(continued)*

### Men's Voices...

The way most of the kids and myself found out that we had been circumcised was when a new kid enrolled in our class. While we were changing for swimming and life-saving lessons, he made a comment about us all being chrome domes and proceeded to tell us what a foreskin was and why we didn't have one. (He would periodically call some of us chrome domes as a sort of inside joke, I suppose.) Being young, we thought he was just pulling some sort of joke on us until we looked up circumcision in the dictionary. I suppose I should mention that he was not circumcised. As an adult, when I became fully erect, the skin would feel like it was stretching to the limit and at any moment would tear. This feeling was present even with the use of some type of lubricant. I often thought that if I had more skin on the shaft area, this would ease the problem. I received your initial information packet around the end of November and started to use the stretching method right away. It has been about six weeks now and the skin has loosened up and full erections are more comfortable."

A.L., Phoenix

"I have had no problems with the stretching program and am making good progress, although I have not yet got to Stage 2. I was not sure if the program would work on someone 47 years old, but I can report that it does. I might add, as well, that restoration surprisingly has eliminated a problem I have had on and off since I was a teenager. I have always had an on-again-off-again problem with chaffing and rawness below the crown in the area of the circumcision scar that has caused discomfort, and that the medical profession didn't really seem too knowledgeable about or too concerned in curing. Since I began stretching, and have had this area of skin covered continuously, I haven't had a single instance of rawness or of chaffing. In other words, a foreskin is the cure, rather than skin lotions, and prescription creams.

Thanks for being there. When I have the chance I will be giving you a call one of these days. I'll be looking forward to the publication of your new book, *The Joy of Uncircumcising*."

S.W., San Diego

**2. Moving on Through the System.** For those who wish to continue to re-cover their glans with a restored foreskin, the goal of Stage I is to develop enough skin to allow them to move on to Stage II, the tape-ring procedures as outlined in Chapter 16. If you are one of these males, and you can easily pull your shaft skin out over the glans and 'pucker' it in front of the glans, it is likely that you are ready to advance to the next stage. Read the guidelines at the beginning of Chapter 16. These guidelines are intended to help you determine whether or not you are ready to progress to the next taping style: the tape ring.



# 16

## The Skin-Expansion System Stage II— The Tape Ring

*“Wonderful! I have had great success. This method is so comfortable I hardly know I am taped.”*

**T.M., Niagara Falls**

Many circumcised males will only be able to use the tape-ring procedures presented in this chapter after they have successfully completed a tape-strap procedure as outlined in Chapter 15. Others will have been circumcised with enough remaining shaft skin to enable them to start their restoration program using a tape ring. To use the tape ring, you must have enough shaft skin to allow you to stretch it out beyond the glans and wrap a 7-8 inch length of narrow tape *around* the tip of the skin to form a ring. The cardinal rule is *no pain!* If you can pull the skin forward and tape it in place without pain you are ready to use a tape ring, at least in the daytime. Of the various taping styles throughout the system, most men find the tape ring the simplest and the most comfortable of all (Figure 16-1).

Most men find erections with the tape ring more comfortable than with the tape strap(s) since no tape comes into contact with the glans. On the other hand, the tape-ring procedures typically utilize more skin than wearing a tape strap. Some men report that initially they use a tape strap at night and a tape ring in the daytime in order to prevent uncomfortable nighttime erections. Actually, early in this stage, the on-and-off taping methods provide an even simpler solution to nocturnal erections by allowing the individual to simply remove the tape at bedtime until there is enough skin to comfortably accommodate erections.

### Three Basic Taping Methods

As with the tape strap, the three basic taping methods are: 1) tape on-and-off the skin, 2) tape worn long-term on the skin, and 3) tape on-

**NOTE: This chapter is presented here as in the original publication. In 1992 this information was the most current thinking about foreskin restoration. Since that time, a number of additional methods and devices have become generally available. For more current information, see the National Organization of Resorting Men [www.norm.org](http://www.norm.org).**

### Men's Voices...

“My weekend project will be to get a roll of Durapore—and get to work. Although the aesthetics will leave much to be desired, I'll start on the ring method stretching as soon as possible. With my limited experience with the tape ring, I probably could keep that applied for several days without any discomfort, although the penis would be significantly pushed back by the taping. Since I have not attempted overnight wear, I am not certain if the ring will comfortably contain/restrict an erection. We'll see....Although I have not set any timetable, if I am diligent in the application of the tape ring, I hope to be able to attempt extension devices by autumn (or maybe next spring).

To have a 'buddy' involved in this process makes it all easier. Thanks for the information, support, etc. provided. Also, with BUFF membership/participation, I don't feel as though I am doing this alone or that I am the only one seeking to change things for the better. I'll keep you up-to-date with occasional progress reports.”

J.W., Virginia

“Receiving your letter was like being re-united with a long-ago friend. I don't know whether it

*(continued)*

### Men's Voices...

was because you used to live here, and we might just have passed each other on a regular basis, or it was because I felt a sense of camaraderie in knowing that somewhere there was another man walking around with a weight suspended from his penis. I thought I was the only one.”

U.T., Indiana

“How circumcision has affected my life—let me count the ways!

1. I was born in 1928 and brought up in a large Eastern city that had strong European ethnic groups from Italy, Poland and Germany. My grandfather was a physician and had circumcised my father. My father had me circumcised as an infant.

2. My best friend when I was three and four years old was a boy whose parents had come from Germany in the 1920s. I noticed that our penises were different in that his was covered tightly with skin. We would urinate together often. My stream would come out of the head and travel two feet or so. His stream would come out through his foreskin in a wide ribbon and only travel out a few inches before splashing down heavily. I asked my father why my friend had skin all over the end of his penis. My father said my foreskin had been cut off when I was a baby and that my penis was better. I remember almost going into shock and disbelief that my father would have done that to

*(continued)*

and-off a skin guard. Instructions in the use of each of these methods are included in the description of each of the tape-ring procedures.

### Three Basic Tape-Ring Procedures

These procedures parallel those used with the tape strap: 1) nonrestricted, 2) extended wear, and 3) weighted. The first two tape-ring procedures, nonrestricted and extended wear, rely on the ‘push’ or pressure from the entrapped penile body to provide the needed tension for skin expansion to take place. The weighted procedure, however, further benefits from the added tension of the ‘pull’ of a weight device.

Regardless of the taping method or tape-ring procedure you choose, the tape ring should be fashioned small enough around to hold the skin in place but not so small or tight as to interfere with blood circulation or urination. As a rule, if urine will pass freely, blood circulation will not be obstructed. On the other hand, if the ring is too large or loose, it may slip behind the glans and cause constriction, especially during an erection. If that should happen, remove the tape at once, and form a slightly smaller ring. Again, some careful trial-and-error experimentation may be needed.

### Nonrestricted Procedure

With this tape-ring procedure, you simply remove the tape as needed for urinating, showering, sex, and for sleeping if you cannot yet tolerate a nocturnal erection with the tape ring in place. There are, again, two different versions of this procedure.

### The Tape-on-Skin Version

As noted in our discussion of the tape-strap procedures, there are those men whose skin is resilient enough to allow them to find a tape which they can apply, remove, and reapply as needed with minimal discomfort and virtually no skin reaction. For these men, the use of a tape ring is a simple process indeed.

**1. Constructing the Tape Ring.** There are really only two features of this simple tape ring to consider: 1) turning a 1/4-inch tab at the end of the tape as you apply the ring which allows ready access to the tape anytime you choose to remove the ring and 2) determining the best width of tape for your needs.

The simplest width of tape to use for the tape ring is 1/2 inch, simplest because nearly all tapes can be purchased in this standard width. Many men, however, report that they can wear the tape ring sooner in their program if they cut 1/2-inch tape into two strips and use a 1/4-inch strip of tape to form the ring. Furthermore, many men who use this version of the procedure find that removing a 1/4-inch strip of tape is much more comfortable than removing the wider tape.

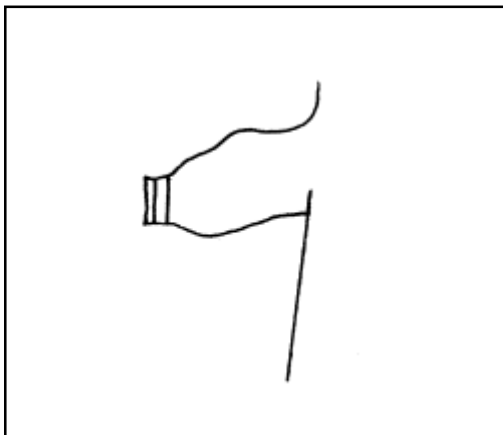

Figure 16-1 Penis with the tape ring applied

**2. Applying the Tape Ring.** The most straightforward application of the tape ring is to simply stretch the skin forward over and beyond the glans and wrap a 7-8 inch strip of tape *around* the tip of the skin to form a ring (Figure 16-1).

**3. A Simple Device for Applying the Tape Ring.** Some men find this simple device helpful in applying a tape ring. Cut a short length (approximately 3-4 inches) of 1/4-inch clear, soft plastic tubing which can be purchased at most hardware stores. Be sure that the ends are smooth! This short piece of tubing is held against the tip of the glans, and the skin is pulled out and around it so that the tape ring may be applied to the skin with the tube in place. The tape is *not* to be applied to the tube in any way. After the tape ring is formed, the tube is gently withdrawn from the skin. Men who use this simple device report that it helps to distribute the skin more evenly under the tape and that it provides a good gauge for creating an opening suitable for urinating through the ring.

**4. Urinating with the Tape Ring in Place.** Whether or not to remove the tape ring every time for urinating is a matter of individual preference. Some men enjoy the sensation of urinating through the taped skin. Others complain that it is messy, prone to cause post-urination dribbling, and requires that they sit down to urinate. Still others have learned to make the ring with just the right size opening so that they can urinate *through* the orifice and not fill the taped skin with urine. Again, experimentation and personal preference are in order here.

### The Skin-Guard Version

Just as with the tape strap, the skin-guard method of taping is for those men who want to remove the tape ring at will but whose skin is too tender or sensitive to allow the repeated removal and reapplication of tape. The principle is simple: 1) A first large (in circumference) ring of tape is applied directly to the skin as a guard and left in place until it loosens and begins to fall off naturally. 2) A second strip of tape, the removable ring, is applied directly on top of the skin guard and removed and replaced as needed. Here, too, some trial-and-error experimentation will no doubt be required, but many men report that the results are well worth the effort.

#### 1. Applying the Skin Guard.

1) Cut a piece of 1/2-inch tape approximately 4-5 inches in length, long enough to form a large ring around your penis which will accommodate a full erection. This piece of tape will be used to form the first ring, or skin guard, applied directly to the skin.

### Men's Voices...

me. I never forgave my father for having me circumcised.

3. When I began attending grade school, I soon became aware that I was one of the few boys who had been cut. When we had gym class, I would never take a shower. I just came in the locker room late when everyone else was already in the shower, put on my clothes, and left. I was hot and sweaty, but could not stand having the other boys look at me.

4. The public swimming pool shower and changing room was another scene that had a psychological effect on me. I would purposely be very slow about dressing just to observe the penis of other boys. They were almost all intact, and I would fantasize about which penis I would like to have. I remember dressing and then undressing several times in a row just to prolong my time in the changing room. Many of the boys did not wear underwear. They would just tuck their penis into jeans or shorts and walk off. This was something I could not do because the chaffing would make my penis hurt.

5. In grades six, seven, and eight, I was in a gang (it was non-violent compared to what goes on today), and I was the only member who had been cut. One of the favorite pastimes was to gather in some basement or vacant building and compare our penises. All the other boys would retract their foreskins and show off the head. This would cause an erection of course so we would all compare lengths and measure ourselves with a ruler. My erection would take place as soon as I pulled my penis out of my pants and touched myself. After everyone had a good look at everyone else, all the intact boys would pull their foreskins forward to cover their penis heads. Most of their erections would be lost (but not all of them). We would tuck our penises in our pants and go on about the gang's business. I remember that my erection would not go down for a long time, and my pants hurt the head when I walked.

6. My penis head hurt as it rubbed my pants. I liked to run, but could not run a long distance without having my penis hurt. I never went out for

(continued)

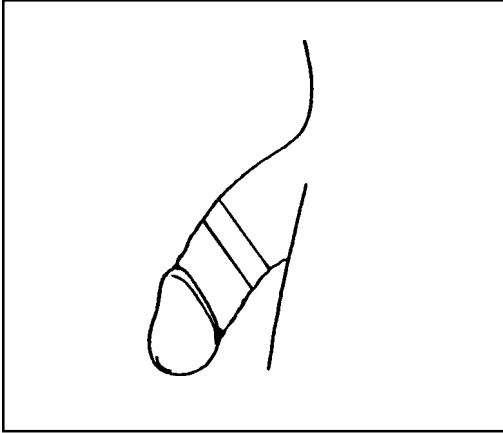

Figure 16-2 Skin guard on shaft of penis

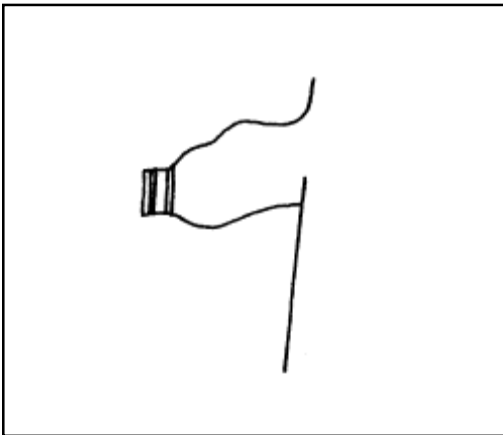

Figure 16-3 Double tape ring in place

2) Pull the skin forward over the glans and, using a nontoxic fine point felt-tip or ball-point pen, lightly mark the location at the tip of the skin where the tape ring is to be placed.

3) Release the skin so that the marked point where the ring will go is back in its usual place on the shaft or just over the glans of the penis.

4) With the skin in its usual position, apply the 4-5 inch piece of 1/2-inch tape to form a large, loose ring around the penis. This is the skin guard (Figure 16-2).

Note: This first layer of tape, while applied firmly to the skin, must be applied very loosely so that it forms a large ring around the penis—large enough to slide back and forth easily over the glans and to just accommodate a full erection when the guard is in place on the shaft of the penis. With a little experimentation, you can learn to mark the piece of 1/2-inch tape before application to indicate the appropriate length it must be so that the resulting ring, the skin guard, will safely accommodate an erection.

## 2. Applying the Tape Ring.

1) When the skin guard has been firmly pressed onto the skin, pull the skin, with the guard attached, back into place in front of the glans.

2) Apply a second strip of tape, which has been trimmed to 1/4 inch in width, directly on top of the skin guard. This narrower ring should be applied tightly enough to pucker the skin guard and hold the skin in place in front of the glans.

3) The result is a narrower, outer ring applied directly to the wider, larger around, skin guard.

4) Since the narrow ring is applied *only* to the outer surface of the skin guard and does not at any point touch the skin, it can be removed and replaced as often as needed for urinating or hygiene needs.

5) The outer ring should have a 1/4-inch tab turned at the end for easy removal (Figure 16-3).

**3. Sex with the Skin Guard in Place.** Some men report that this taping method allows them to engage in sexual intercourse with the skin guard in place on the shaft of the penis by simply using a condom. After sex and a quick shower, they use a hair dryer to dry the guard as quickly as possible and reapply the outer ring.

## Extended-Wear Procedure

This tape ring is identical in form and function to the tape-on-skin version of the nonrestricted procedure, as described above. Again, determining the width of tape to use and being sure to turn a tab at the end of the tape are the only two considerations in fashioning the standard tape ring.

**1. The Standard Tape Ring.** The unique feature of this procedure is that the tape ring is worn continuously and is not removed for urinating or bathing. As noted in Chapter 14, Ameri-

cans typically bathe and scrub more frequently than other peoples. Some men, however, find that they like the *degree* of sensitivity which is regained when they leave the skin in place over the glans for longer periods of time—usually the two to four days that it takes for the tape to loosen and begin to fall off naturally. For those men who particularly enjoy their regained sensitivity, urinating sitting down or learning to fashion the ring with just the right size opening to allow them to urinate through the orifice are well worth the extra effort. Obviously, basic hygiene must always be practiced, but daily cleansing under the skin is typically not required.

**2. The Elastic Tape Ring.** There is a variation of the extended-wear procedure which some men appreciate because it functions more nearly like a natural foreskin. As you will probably know, there are elastic surgical tapes available on the market. Some men use an elastic tape to form a somewhat loose tape ring on their skin. Such a ring made of elastic tape allows the individual to retract the skin back off the glans for urinating and bathing and to replace the skin over the glans without removing the tape. Then, at night, a second, narrower ring of *nonelastic* tape is put on top of the elastic ring. This second ring ‘locks’ the skin in place and prevents the elastic tape ring from being pulled back onto the shaft of the penis during nighttime erections where it might restrict blood flow.

### Weighted Tape-Ring Procedure

The weighted tape-ring procedure provides additional tension by use of a weight device. This ‘bell-and-bearing’ device is constructed such that a latex bell or cup is worn *inside* the skin over the glans. Its design allows the user to urinate with the device in place. Therefore, should the individual desire, it can be worn for several days at a time, until the tape ring holding it in place loosens and begins to fall off naturally.

**Caution:** Since the shaft skin is held *between* the bell of the device and the tape ring, you must be sure not to use so much weight pulling against the tape ring that the blood flow to the tip of the foreskin is restricted. Be sure to test for blood circulation as discussed in Chapter 14. It is also wise to watch to be sure that there is no skin reaction to latex-type products.

**1. Materials.** You will need: 1) either a wide-base nipple made for disposable baby bottles or the tip end of an *external* male catheter, available at many pharmacies, 2) two small ‘continuous,’ or split-wire, rings, 3) a steel ball bearing 1 to 1 1/2 inches in diameter, and 4) two 1/4-inch strips of tape 7 to 10 inches long for use on the bearing.

#### 2. How to Assemble the Bell-and-Bearing Device.

1) Cut and tailor the bell-shaped portion of the nipple or external catheter to fit over your glans and trim the length of the nipple or tube portion to

### Men's Voices...

sports of any kind because of this constant rubbing and because of the locker room embarrassment. When I would pull my penis away from my tight underwear, my mother would slap my hand and tell me not to touch myself there. Once I was in my room masturbating, and the bed squeaked a little bit. My mother came into my bedroom and told me not to play with myself or I would go blind, insane, or both. I wanted to tell her that I had watched boys with foreskins play with themselves, and I couldn't do it right anyway. But I just kept quiet.

7. High school was really bad. I went on the bus to a big school in the inner city. Again, I was one of the few circumcised boys. I would try to use the toilet stalls to urinate, but there were not too many of them, so I more than often had to use the urinals. Boys with big uncircumcised penises would purposely stand on each side of me. There were several of them who thought this was great fun. They would retract their foreskins slowly so just the tip would show, then step back slightly and urinate, all the time watching me watch them. Then they would retract their foreskins all the way exposing the entire head and shake their penises. Then the foreskin would be pulled forward and they would shake it again. This stroking and shaking would be done three times. They had a saying, ‘If you skin it back more than three times, you are playing with it.’

8. More high school embarrassment... Showers were mandatory in high school and I could not get out of it. As in most school showers, there was no privacy at all. The intact boys would skin back their foreskins in front of me. There were a few again that delighted in doing this to tease me. They would then say, ‘Do you wish you could do this?’ When we would be drying off, some of them would come around me again, retract their foreskin slowly and say, ‘This is what my girl friend likes to do. How can girls play with you? You haven't got any skin!’ They usually didn't call it foreskin, just skin.

9. College was a little better. There were still some boys who liked to show off their foreskins when they saw I was cut.

(continued)

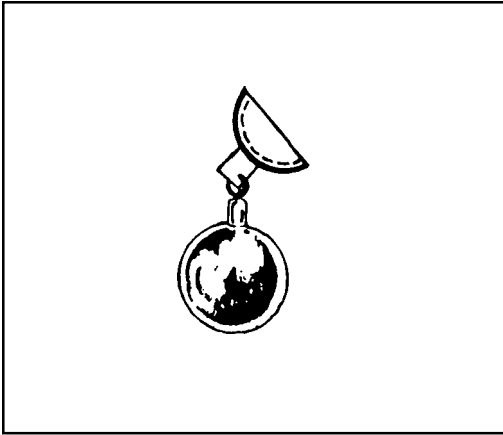

Figure 16-4 Bell-and-bearing assembly

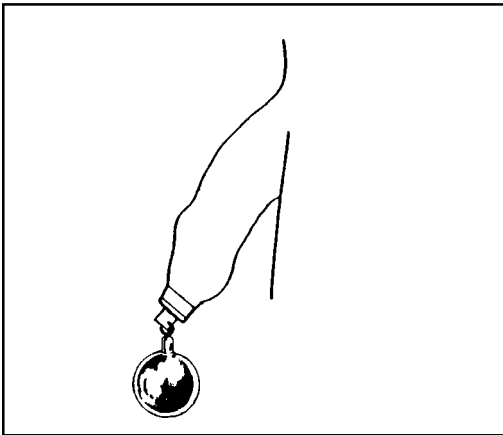

Figure 16-5 Device in place on penis

### Men's Voices...

10. Marriage came after college. My wife didn't seem to care that I was cut. Her little brother was cut and she was used to it. I had to tell her not to touch the head of my penis because it was tender. Sex was good for 25 years. Then the head of my penis started to have a coarse texture and became insensitive. I had a difficult time having an erection, and when I got one, I could not maintain it.

11. About 1983, I contacted NOCIRC about foreskin restoration. The kids were grown and I had the money for an operation (I assumed that

*(continued)*

form a channel for urination, long enough to extend beyond the foreskin when the bell is in place over the glans. Be sure that all cut edges are smooth and rounded!

2) Pierce a small hole near the tip end of the urine tube and attach one of the 'continuous' wire rings through the hole.

3) Apply the tape strips around the bearing such that the second 'continuous' wire ring is securely attached to the bearing (Figure 16-4).

### 3. How to Apply the Bell-and-Bearing Device.

1) Place the bell-shaped chamber over the glans and roll or push the skin up and over both the glans and the chamber. Properly placed, the urine tube will project through and beyond the foreskin.

2) Apply a tape ring around the foreskin with the tube protruding. Be sure that the tape is not so tight as to cause constriction.

3) By interlocking the two 'continuous' wire rings, the bearing is attached after the bell is in place and is easily removed for urinating and sleep (Figure 16-5).

**4. Taping Method.** With some trial-and-error experimentation, this device can be worn with any method of taping: 1) tape on-and-off the skin, 2) tape worn long-term on the skin (for extended wear), and 3) tape on-and-off a skin guard.

**5. Instructions on Care and Use of the Bell-and-Bearing Device.** The following instructions and cautions are intended to make the use of this device both simple and safe.

1) If the device is left in place for urination, careful attention must be paid to cleaning the bell between applications. Some men prefer to have two bells so that this portion of the device can be worn, washed, and dried alternately.

2) *Do not leave the bearing attached during sleep.* It seems both unwise and unnecessary to leave the bearing attached during sleep. Not only is there no pull of gravity to produce tension, the bearing is apt to cause discomfort and pain in various positions of the body and of the penis during sleep.

3) Some men choose to attach more than one bearing. The rule is clear, beware of restricting the blood flow. With caution, however, you may want to try two bearings attached to the tube since the bell-shaped portion of the device provides neither significant weight nor bulk within the foreskin to contribute to the needed tension.

## Joys of Stage II

The initial and later joys of Stage II seem to merge. From the very start of this stage, the benefits are enormous.

**1. The Glans Completely Covered with Skin.** If the glans feels 'at home' when partially covered with skin while wearing a tape strap, the snug feeling of having the glans completely enfolded in its own

skin ‘home’ while wearing a tape ring, is for some men, absolutely incredible.

**2. Psychological Reactions.** This stage, more than the others, feels ‘natural’ to many men. The skin held over the glans with a simple strip of tape, the bunched skin beyond the tape ring, and the outline of the glans beneath the shaft skin all *appear* rather natural—at least more natural than these men have ever looked or felt before in their life!

**3. Increasing Comfort.** Obviously, most men have to learn to apply the tape ring so that the results are uniform from time to time. And, at first, there often isn’t really enough skin to be truly comfortable. But, in a surprisingly short time, the procedure becomes routine, and the results are incredibly comfortable. So much so, that some men wait awhile before moving on to Stage III just because they so enjoy having their glans so comfortably ‘housed’ inside their developing foreskin.

**4. Options.** This stage, with its relative ease of urination and comfort, seems to provide a variety of easier life-style options. Some men, for instance, will venture into a public rest room or a gym wearing a narrow band of flesh-colored, elastic tape which can be retracted for urinating, while the same men avoided these public places with the more obvious tape strap(s) on their penis. Furthermore, at various times, the individual who typically removes the tape to urinate can on occasion choose to urinate through the ring since there is now no tape strap in the way.

**5. Sensitivity.** Sensitivity continues to develop over time and may well reach its peak during this stage, especially with those procedures which provide continuous, skin-to-skin contact between the developing foreskin and glans.

**6. Mobility of the Shaft Skin Combined with the Developing Foreskin.** The mobility of the shaft skin itself no doubt reaches some point of stability, but, as the skin continues to expand, there is an increasing amount of penile covering to move on the shaft of the penis and over the glans. There are, of course, very real individual differences, but this feature of the skin-expansion system is one which most restoring males never fail to comment on—particularly the role of this added skin and mobility in foreplay.

**7. The Glans Partially Covered Without Tape.** Again, individual differences are important to bear in mind. Most men, however, by the time they are comfortably working in Stage II, have at least some coverage of their glans when they are not wearing tape. By the end of this stage, many men have quite respectable coverage, usually when they are completely flaccid.

## Men’s Voices...

my medical insurance would not cover this). My wife was against this and did not want me to pursue it any further. Information about the various methods of surgical foreskin restoration scared me as well. I was especially concerned about the success rate at that time.

12. I then contacted BUFF and started the stretching procedure using surgical tape. I have been taping for about eight years now. I have developed a foreskin by stretching that is fairly good. There is a lot wrong with this artificial foreskin, but there are some very positive things as well.

Advantages: The head of my penis is a darker color and has a very smooth texture. It is very sensitive and I cannot touch it without having an immediate erection. Intercourse feels better, and is more exciting than it has been in many, many years. I can masturbate with long strokes and the foreskin moves up and down the head fairly well. But I have to be careful not to let my hand rub the head or it will hurt. I can wear pants without underwear in the summertime. Chaffing is not a problem at all because the head is protected. I notice a big difference in the wintertime as well. I like to ski, and my penis would sometimes feel like it was freezing before I stretched a foreskin. Now I am very comfortable in below zero weather. I can remove the tape ring while showering and changing in public, and the foreskin stays in place completely covering the head. Circumcised men and boys stare, and I think I have them fooled. I have on several occasions overheard cut boys ask their cut fathers what was wrong with my penis. I am not sure I can fool uncut men, however. They do not pay much attention to me, but I am sure they wonder why I do not retract my foreskin in the shower as they do.

Disadvantages: Concerning the last item under advantages, the foreskin will not stay in place and cover the head of my penis any longer than about five minutes without the tape ring being tightly in place. Also, if I retract the foreskin, even just once, it will not tighten down on the head and stay in place without replacing the tape ring. I usually do not take the tape ring off while urinating.

(continued)

### Men's Voices...

This makes my penis appear weird and I attempt to hide it in the urinal. Some urinals are just a low open bowl and there is no way to hide anything. Many times I know I have observers at work and I don't want them to see the tape ring. In this case, I slip the tape ring off into my hand as I am pulling my penis out of my pants. I then just go ahead and urinate through the tight foreskin and a nice ribbon splashes down. Then comes the difficult part. There are quite a few drops of urine left in the foreskin, and there is always some in the shaft of the penis anyway. To avoid getting my pants all wet, I must retract the foreskin and stroke and shake my penis. This causes an immediate erection that I have to deal with. I usually go into a toilet stall, stretch the foreskin over the head, and replace the tape ring. This is sometimes a problem in that I am talking with someone and feel I must leave with them and not go into a booth after just urinating. Also, sometimes I have dropped the tape ring into the urinal and I am too embarrassed to retrieve it. I then begin to panic because I cannot walk very far before the foreskin is fully retracted, the chaffing hurts, and I get an erection. One other minor problem is that my new stretched foreskin has hair. I have light-colored hair so it does not show very much. I would anticipate that dark hair on a foreskin would not appear very natural.

13. Future Plans: I am resigned to using a tape ring in the future. I use 1/4" wide transparent plastic surgical tape. It is cheap and readily available (I tear 1/2" tape into two strips).

14. Alternate Plan: I would consider a small tuck being taken in my foreskin to tighten it over the head so I would not have to use tape. I am concerned that it would have to be so tight that it would not freely retract during masturbation and intercourse. I know for a fact that this is not a problem in uncut men, but they have a real foreskin which was made to work right.

The psychological damage of being circumcised has caused me a great deal of grief and will always be with me. I had my sons circumcised because I believed the cancer propaganda of the 1950s. It was the worst mistake I ever made. I am having some success trying to break the chain with my grandsons."

A.C., Atlanta

### How Long Does Stage II Take?

Again, I feel obligated to say something about the time factor since it is so often asked about. And, again, I must be vague. A host of anatomical and physiological features bear upon the overall duration of each stage: the relative size of the glans compared to the shaft-skin covering, the relative size of the penis when flaccid as compared to when erect, etc. Further, the ease with which an individual's skin expands must also be taken into account. Therefore, for some men Stage II is a relatively brief stage of only two or three months; for others it can last a year or more. It seems important to point out here again that most men come to truly enjoy this stage of the system.

### The Goal of Stage II: The Point of Equilibrium

The completion of Stage II is reached at the point where taping the skin forward over the glans no longer provides sufficient tension for further expansion. The penis itself will no longer provide the needed tension. At this point, the point of 'equilibrium,' the skin will not expand much further by means of the rather simple procedures used thus far.

**1. Stopping Here.** If you choose to stop the skin-expansion system at this point, you will have achieved the addition of a significant degree of shaft-skin mobility and partial coverage of the glans at certain degrees of the flaccid state without tape. As noted in our discussion of the goals of Stage I, if you are pleased and satisfied with these results and you want to discontinue the system, by all means do so. You will have already proved to yourself that you can accomplish some really good things for yourself, and you will certainly have a more 'natural' penis than ever before.

**2. Moving on Through the System.** For those who decide to continue and to completely re-cover their glans with a restored foreskin, the goal of Stage II is to develop enough skin to allow the individual to move on to the use of an expansion device which will further expand the skin. Read the guidelines at the beginning of Chapter 17. These guidelines are intended to help you determine whether or not you are ready to progress to the next stage of the system: expansion devices.



# 17

## The Skin-Expansion System Stage III— Expansion Devices

*“You have to fool the skin into believing that your penis is growing to an incredible length.”*

JB

Up to this point in the skin-expansion system, the bulk and weight of the entrapped penis has provided a major contribution to the tension needed to bring about skin expansion. At this point, the point of ‘equilibrium,’ the penis itself is no longer effective, on its own, to provide the needed tension for further skin expansion. From this point on in the system, some device will be needed to provide the tension for continued skin expansion. Technically, those men who have been using the weighted procedures in the earlier stages have already been using expansion devices. Now, however, all men who continue their restoration program will need to discover a suitable expansion device. And even those who have used the weighted procedures in earlier stages of the system may find other devices more suitable now that they have more skin with which to work.

As a grassroots movement, all of the techniques, devices, and innovations used by men to expand the skin of their penis have come from those participants willing to share their ideas and discoveries. Stage III, with its use of some device to provide continued tension, has generated, without a doubt, the widest variety of both ideas and contraptions.

### The History of Homemade Expansion Devices

The earliest expansion devices worn by BUFF participants in the early 1980s involved the use of an elastic strap to provide the needed tension. First, the individual either applied a tape ‘splint’ to the exterior of his burgeoning foreskin or wore a hollow, spool-like device within his foreskin which was stretched out and taped around and to the spool. In either case, he then attached one end of an elastic

**NOTE: This chapter is presented here as in the original publication. In 1992 this information was the most current thinking about foreskin restoration. Since that time, a number of additional methods and devices have become generally available. For more current information, see the National Organization of Resorting Men [www.norm.org](http://www.norm.org).**

### Men’s Voices...

“To start, I am 38 years old, Caucasian, and from a middle-class family. I was circumcised at birth and resent the fact that I did not have a choice. I blame society first and then the doctors, but not my parents. I should also state that the penis has always fascinated me. The foreskin intrigues me, perhaps because mine was taken. I have studied much about the penis, but the most interesting part has been the foreskin.

I started taping the skin over the end of my penis and it wasn’t long before I noted an increase in the sensitivity of my glans. In reading a magazine I came across information about foreskin restoration. From there I discovered an organization called BUFF and was well on my way to recovering my glans. It took three years to gain as much skin as my friend with the foreskin had. I would have liked to gain more, but I was tired of the daily taping. Although it is not quite the same as the real thing, it is as close as I will ever come.”

T.J., Denver

“I have a request that may seem a little odd considering the area that I reside in, but I can’t find a company (medical supply, ball-bearing manufacturer, or the like) that carries stainless

*(continued)*

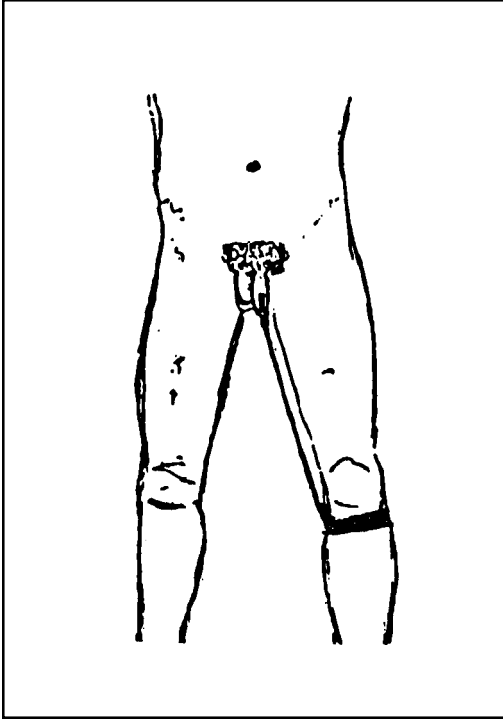

Figure 17-1 Early expansion device

strap to the tip of the tape splint or of the protruding spool. Next, he stretched the elastic strap and either attached the other end to a garter worn below the knee of one leg or he pulled his penis, with the strap attached, backward between his scrotum and one leg. He then attached the other end of the stretched strap to the back of a garter belt worn at the waist. Needless to say, the use of such cumbersome devices required a great deal of trial-and-error fitting and was a major source of discouragement to more than a few who tried them! (Figure 17-1).

On a far simpler level, objects worn within the developing foreskin to provide further tension beyond that provided by the glans itself have been many and varied: cotton balls, a large marble, a small rubber ball, a steel ball bearing, etc. In each case, the attempt has been to provide either bulk, weight, or both within the developing foreskin in addition to the glans itself. Sanitation, the need for urination, safety, and convenience are all factors which must be considered in the use of such objects. Through the years, particular expansion devices have come to be recognized as providing the safest and most convenient means of creating the gentle tension needed for the final stage of foreskin expansion. It is these very basic devices which will be presented here.

### **When to Use an Expansion Device**

You are ready to begin to use an expansion device such as those described in this chapter when you have reached the point of equilibrium: that point at which taping the skin forward over the glans with a tape ring no longer provides sufficient tension to produce further expansion. At this point, most men will be able to experience a full erection while the skin is held forward over the glans with a tape ring with virtually no discomfort. Although at this point there will typically be at least partial coverage of the glans without tape when the penis is flaccid, the restored 'foreskin' in most instances is not long enough to remain in place over the glans for long periods of time. To achieve more complete and reliable coverage of the glans, additional expansion is required. Typically, a circumcised male will reach the point of equilibrium only after having used some initial expansion procedure(s), although a few men have been circumcised with enough skin remaining on the shaft of their penis to allow them to begin a restoration program with the immediate use of an expansion device.

### **General Statement of Caution**

There is an understandable desire on the part of many men to want their restoration program to go faster. Men frequently express regret that they did not know about the possibility of foreskin restoration

earlier in their life. These men can get overanxious and attempt procedures for which they are not yet ready. In light of these facts, it seems wise to restate the caution not to use force of any kind. If you have truly reached the point of equilibrium as described above, you will have no trouble using the procedures described in this chapter without undue discomfort and with *no pain!* Until then, be patient and continue doing those things which you can do easily and safely.

### Three Basic Taping Methods

Since each of the expansion devices presented in this chapter is held in place with a tape ring, it seems wise at this point to briefly restate the three basic methods of taping with a tape ring and how each method relates to the choice of a device. Note, when using any on-and-off taping method, be sure to turn a 1/4-inch end tab for quick and easy tape removal.

**1. Tape On-and-Off the Skin.** This is the simplest tape-ring method. If your skin will tolerate the repeated application, removal, and reapplication of the tape, you can choose a device which is removed each time for urinating, showering, sex, or sleeping depending on the device. Either 1/4-inch or 1/2-inch tape may be used.

**2. Tape Worn Long-Term on the Skin.** This tape ring is applied directly to the skin and is used with a device which is worn continuously for several days. Such a device must allow urination through the device and accommodate a full erection. The tape ring is removed only after several days when it has begun to loosen naturally due to body oils, sweat, etc. Either 1/4-inch or 1/2-inch tape may be used.

**3. Tape On-and-Off a Skin Guard.** This on-and-off method of taping, detailed in Chapter 16, allows you to remove and reapply the outer, narrower tape ring as often as necessary without pain or damage to the skin while leaving the wider skin guard, applied to the skin, in place for several days. This taping method can be adapted for use with any device which is removed regularly for urinating, showering, etc. Both 1/4-inch and 1/2-inch tape are used in this method of taping.

### Two Basic Expansion Devices

The two basic devices to be presented here have been selected because 1) each has a known track record; 2) each can be coupled with an appropriate choice among the three taping methods outlined above; 3) each is simple to make from materials readily available; and 4) each is known to be safe when properly constructed and applied and when simple precautions are observed. The two basic devices to be discussed are 1) the foam rubber cone and 2) stainless steel ball bearings in tandem.

### Men's Voices...

steel balls. I have been able to obtain chrome, but they tarnish and I don't feel at ease using them. I know that the organization was trying to find a method for attaching the balls together so the tape wouldn't be necessary. Has any progress been made in that area? I would appreciate if you could direct me to a supplier that would be able to sell the stainless balls.

By the way, I have used the tape technique for almost eight months now and the skin is just about ready to continue over the head. When I take the tape off and see the skin remaining there, I can't tell you the feeling of gratitude I have for you."

C.D., New York

"I just received your information and read it all thoroughly. I have been practicing taping for six years, but at an intermittent pace. I see now that I should have lived with that tape round-the-clock. I've also used rubber 'o-rings,' although they tend to fall off once in a while. Generally, I am well pleased with the results of my stretching, although my progress is far from the goals I have. I am at the point now that I need to expand upon the tape ring treatment, so could you please send me additional information. Surgical restoration is beyond my current financial means, but I would have it done in a heartbeat if I could. Actually, I feel that what I have accomplished with stretching has been enough that I could keep my glans covered if I could get the tip of the foreskin reduced in diameter 'tightened up.' I sincerely desire to grow a long, tapered foreskin with a lot of overhang. I'll keep stretching and working toward that goal.

As you can see, I want to read everything available on the circumcision, restoration, and foreskin. God bless and thank you for your help!"

G.S., Jacksonville

"I am now completely recovered. I've been completely recovered for eight years when flaccid. Now the taping has gotten me completely recovered when erect if I go into a slightly fetal position.

(continued on page 174)

## The Foam Rubber Cone: Construction and Use

The foam cone is worn within the foreskin and utilizes gentle, persistent pressure to provide the tension needed to expand the foreskin further. The foam cone has several advantages. It is lightweight and unobtrusive. It is relatively easy to make, and it is comfortable to wear.

### Cautions

The relatively soft feel of foam rubber can be deceiving. Be sure not to use a cone which is too long for you or which does not have smooth surfaces. Such conditions can lead to constriction of blood circulation (see circulation tests in Chapter 14) or can exert undue pressure on the glans and skin which may cause tissue breakdown and ulceration. If any sign of such tissue damage should appear, discontinue your program and consult your doctor at once!

### How to Make the Basic Foam Cone

The basic foam rubber cone is designed to be used with either of the on-and-off taping methods: tape on-and-off the skin or tape on-and-off a skin guard. Whichever of these methods you choose, the cone must be removed each time for urinating and bathing.

**1. Selecting the Foam.** Foam rubber is available in various densities. The correct foam will be 1) firm enough to hold its shape but 2) soft enough to compress slightly in order to provide tension and to be comfortable and not cause damage to the glans or skin. Foam rubber shops and upholstery repair shops are good sources for foam rubber, although various sorts of foam from a variety of sources have been used.

**2. Shaping the Cone.** Begin with a piece of foam which is slightly larger around and longer than the finished cone is to be. Use a pair of sharp scissors with narrow blades to shape a chamber in one end of the foam which will fit comfortably over the entire *erected* glans. Take time to fit the chamber to the glans as neatly and comfortably as possible. The inner surface of the chamber should be smooth and free of ridges or pits.

Next, sculpt the outer shape and surface of the cone such that it resembles the general contours of the glans. Again, the surface should be smooth with no sharp edges or protrusions. The finished cone should look something like the example in Figure 17-2.

### How to Make a Hollow Cone for the Extended-Wear Procedure

This cone is designed to be used with tape worn long-term on the skin. The cone is worn for several days at a time and is constructed to allow

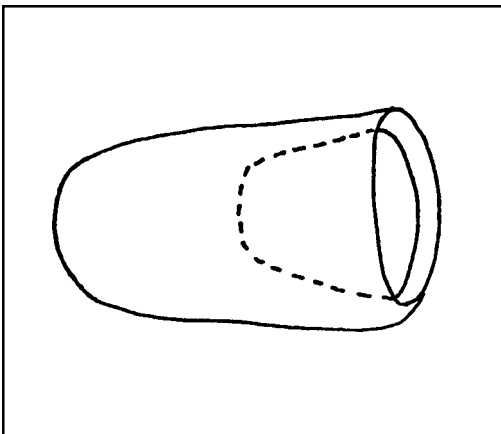

Figure 17-2 Foam cone

for urinating through the cone. Further, it will typically be relatively shorter than the basic cone, at any given point in the individual's program, since this cone must not be so long that it will interfere with nocturnal erections.

**1. Channel for Urination.** Fashion a cone according to the basic instructions above. Then, hollow a channel from the chamber out through the tip of the cone (Figure 17-3).

**2. Waterproofing the Cone.** A thin layer of nontoxic aquarium sealer or clear caulk sealant may be used to waterproof *all* surfaces of the cone. It is important to be sure that you are not allergic to such products before long-term use is undertaken. Note also that cones which are hollowed for urination typically require a somewhat firmer foam than those which are not.

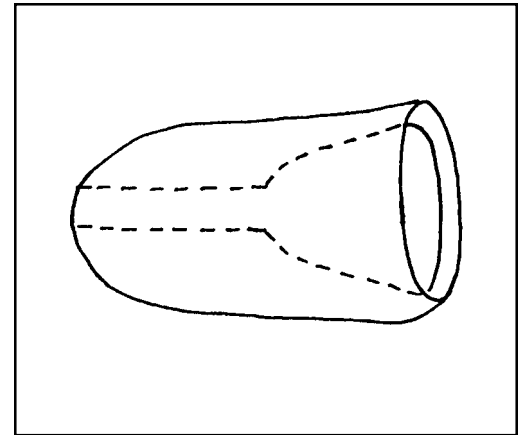

Figure 17-3 Hollow cone

### How to Apply the Cone

Place the cone, of either design, comfortably over the glans. Roll or gently push the skin upward and over the cone, which extends beyond the glans. Tape the skin in place with a tape ring. Use whichever taping method is appropriate for your skin, your choice of cone design, and schedule of wear.

### Cones in Graduating Sizes

One of the advantages of choosing the foam cone as your expansion device is that the first cone need only be slightly larger than the glans itself. This fact means that such a cone can typically be worn sooner than other, larger devices.

When the skin has expanded to accommodate the cone currently being used, another cone is made slightly longer and so on throughout the final stage of the system (Figure 17-4). Each increase in cone size

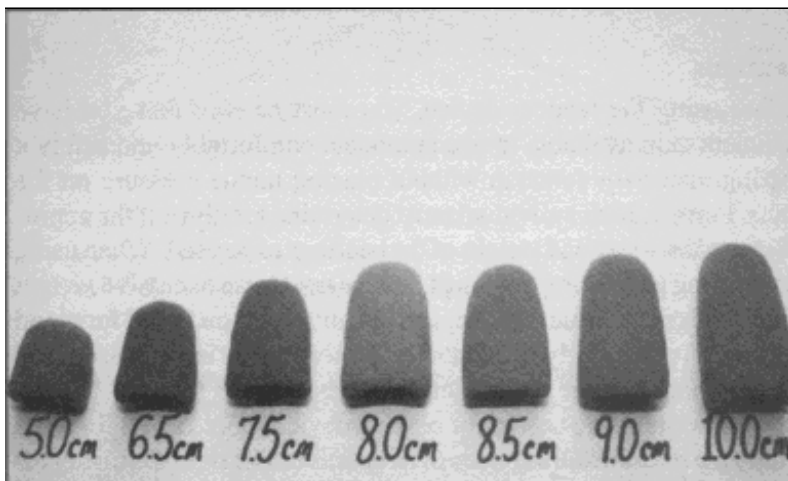

Figure 17-4 Series of foam cones

### Men's Voices...

I didn't even know I had been circumcised until, in college, I saw my first uncut penis. I am mighty mad that some stranger had the nerve and audacity to cut off part of my penis. Now my wife likes the looks of a uncircumcised penis. But years ago she wanted our son circumcised. The doctor's first words when he showed us our first born were, 'You want him circumcised, don't you?' At the time I didn't know what I know now. I shouldn't have let him do it."

Dentist, Wisconsin

"Can I get the information on the ball-bearing device? I have used a ball bearing previously in my stretching, but found that the moisture in my new foreskin promoted corrosion so I stopped using it.

I was tightly cut as an infant, with no skin left over. After four years of stretching, I now have complete coverage when flaccid. I am happy with the results I have gotten so far. My foreskin looks very natural. I went to a new doctor recently and he commented that he was surprised that I was uncircumcised—he saw so few foreskins on his male patients (he was born in Greece).

At any rate, my goal now is to have complete coverage with an erection. I have found this stage frustrating because the cone devices I have been using seem to only extend the new skin I have already created most of the time (except when I get hard, when the extra tension pulls the skin tighter). Your double ball-bearing method sounds interesting—I am willing to give anything a try! After four years of stretching, I am getting to the point that I want this thing finished already."

W.A., Pennsylvania

"The new method of stretching is working quite well, although I am not totally comfortable with the weight. It is quite similar to when I first began taping, which was very uncomfortable at first, but after a while I had to think if I was taped or not."

M.P., Tennessee

should be made with care. Again, force is unnecessary and can be harmful. Only gentle, steady pressure is needed.

### The Care and Use of Foam Cones

The following instructions will make life with foam cones easier.

**1. Washing the Cones.** Cones should be washed in mild soap and warm water. After thorough rinsing, the cone should be left to air dry for several hours.

**2. Using More Than One Cone.** If you make two cones of each size, one cone can be drying while the other is being worn.

**3. Using Different Size Cones.** If you choose a taping method which allows you to remove the cone at will, you may find that a somewhat shorter cone worn at night will better accommodate nocturnal erections. Likewise, a longer cone can then be worn in the daytime than would be the case when the same cone is worn both day and night.

### Stainless Steel Ball Bearings in Tandem

The use of ball bearings utilizes weight and gravity to provide the tension needed to expand the foreskin further. As noted earlier, men have often used a single ball bearing worn within the foreskin as part of their expansion program. More recently, a simple device utilizing two bearings in tandem has been devised. This device calls for a smaller bearing to be worn inside the foreskin while a larger bearing hangs free outside the foreskin beyond the tip of the penis. The major advantages of this device are 1) that it is very simple to make and 2) that it does not require periodic redesign and replacement as does a series of cones. Further, the general shape and size of the device allows it to be worn virtually without detection—except, of course, at the airport!

### Cautions

Before using the tandem device, you must be sure that you have sufficient skin available to accommodate comfortably and safely a bearing inside the foreskin without placing undue pressure on the glans. Further, each individual must determine for himself the appropriate and safe size and weight of the bearings to be used. When using any bearing procedure, you must be sure not to use excessive weight which can cause tissue damage, and you must be sure to test for blood circulation particularly in the skin held between the inner bearing and the tape ring. Use the circulation tests described in Chapter 14.

Furthermore, no bearing or bearing device should be left in place within the foreskin during sleep or an erection. The risk of bruising the

glans or damaging the skin due to an erection with a bearing in place is too great. For around-the-clock tension, use either a tape ring only or a small foam cone for nighttime wear.

### The Tandem Device: Assembling and Use

As with the basic foam cone, the tandem device is designed to be used with either of the on-and-off taping methods: tape on-and-off the skin or tape on-and-off a skin guard. Whichever of these methods you choose, the device must be removed each time for urinating and for sleeping.

**1. Selecting the Bearings.** Ball bearings come in many sizes and are made of a variety of materials. It is suggested that the tandem device be made of one 1-inch bearing and one 1 1/4-inch bearing and that they be of high-grade stainless steel so as not to tarnish or be likely to cause a skin reaction. Two such bearings will weigh approximately 7 ounces. If you are unable to purchase stainless steel bearings locally, or would like information on a prefabricated, all stainless steel tandem device, contact R. Wayne Griffiths (see listing under RESOURCES).

**2. Assembling the Device.** You will need two bearings and a roll of 1/2-inch cloth tape to make this device.

- 1) Begin with a piece of tape approximately 14 inches long. Cut the tape lengthwise into two 1/4-inch strips.
- 2) Place the center of one tape strip onto the smaller bearing (Figure 17-5).

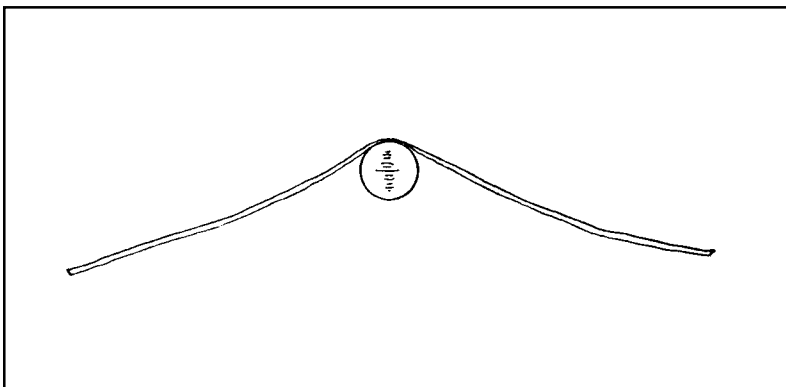

Figure 17-5 Bearing against tape

- 3) Continue to apply the tape around the bearing until the tape strands meet. Press the strands together for approximately 1/8-1/4 inch (Figure 17-6).

### Men's Voices...

"I received the weights earlier this week and have been using them for several days. However, I added a safety rope to them using dental floss. I placed a slip knot over the bar portion and tied the other end securely to a safety pin. That way, if the tape gives, there will be a tether to prevent an embarrassing situation in public. Thought I would pass this along in case no one else has come up with a solution to prevent sudden surprises.

Thank you again for fabricating the weights and sending them to me, and especially for the support and encouragement you provided at the meeting by showing that it is not weird or abnormal to want to restore what has been taken."

H.K., Arizona

"I was born in San Francisco in 1933. I have an older brother four years my senior, a sister eight years younger, and a brother fourteen years younger. My dad, my brothers and I are all circumcised. Having seen my dad and my brother naked, as well as from observing the other naked men in the course of my life, I can say that my dad, my brothers and I had some frenulum and a small amount of extra skin under the glans. We were not skinned as tightly as others are. When I masturbated, I could always pull some skin up on my glans and I always tried to pull more over, but with limited success.

As a boy I had participated in group masturbation sessions where some of the other guys had to rub up and down, and I could masturbate with my loose skin. I have always been fascinated with those who are not circumcised. However, I have never had any hang-ups, or been angry at my parents or anyone else because I was circumcised. It was a fact of my life, and I have always enjoyed my private parts.

I remember when I was in Boy Scouts that two of my friends were uncut. The father of one of them was on the group's committee, and during a conversation that included men and boys, the subject of circumcising or not circumcising came up. He was very adamant about the fact that

*(continued on page 178)*

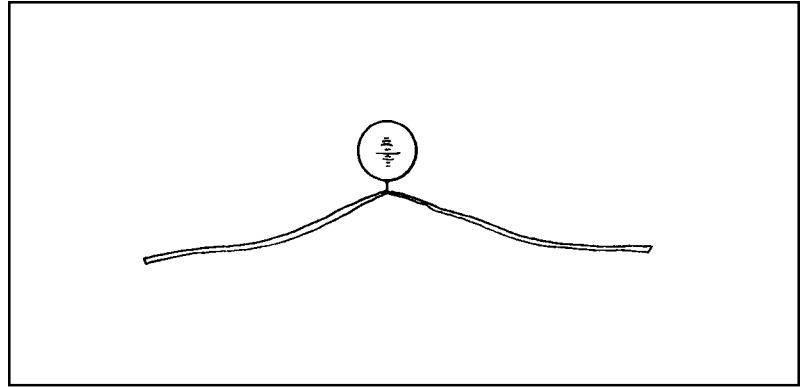

Figure 17-6 Bearing with tape around

4) Place the larger bearing against the two tape strands where they are joined together (Figure 17-7).

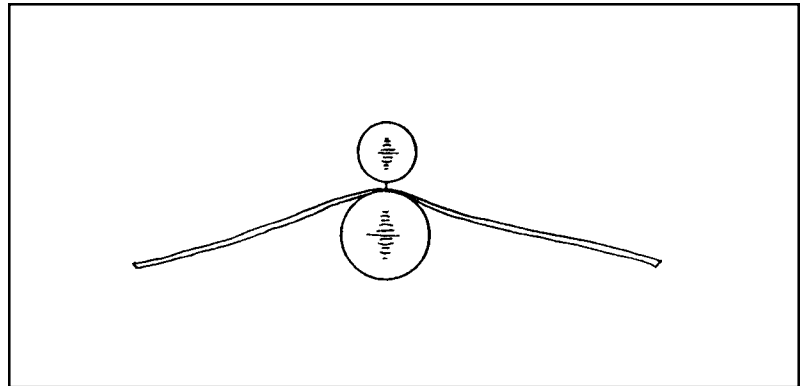

Figure 17-7 Larger bearing in place against tape

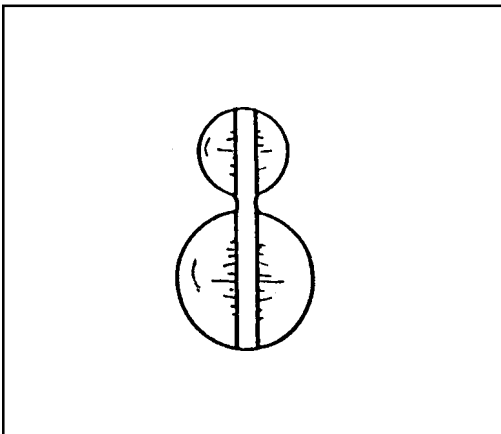

Figure 17-8 Two bearings with single strand in place

5) Continue to wrap the tape strands around the larger bearing, first one strand and then the other. The tape strands should each be long enough to come fully around the larger bearing and join back in where the tape is stuck together between the two bearings (Figure 17-8).

6) Using the second 1/4-inch strip of tape, repeat steps 2,3, 4, and 5. Position the second strip such that it divides the bearings into quarters (Figure 17-9).

7) Finally, wrap a short, narrow piece of tape around the tape strands between the two bearings to form a neat, secure joint.



### How to Apply the Device

Place the top of the smaller bearing against the tip of the glans. Roll or push the skin up and over both the glans and the bearing. Apply a tape ring around the tip of the skin in front of the smaller bearing (between the two bearings) such that the smaller bearing is enclosed within the foreskin and the larger bearing hangs free in front of the foreskin and penis (Figure 17-10).

### The Care and Use of the Tandem Device

The following information is intended to make the use of the tandem device both safe and easy.

**1. Hygiene.** The tape should be changed periodically on any such bearing worn regularly within the foreskin. Tape residue may be removed from the bearing with either acetone or paint thinner. The bearings should then be washed with soap and rinsed well before tape is reapplied.

**2. Use of a Foam Cone at Night.** Some men feel that using only a tape ring at night does not provide sufficient tension once they have arrived at this advanced stage of expansion. These men sometimes find it helpful to use a foam-cone ‘retainer’ at night, even though they prefer the tandem device for daytime wear.

### Extended-Wear Weighted Device

Before leaving our discussion of weighted devices used in the final stage of the program, it should be pointed out that some men prefer to continue to use the bell-and-bearing device described in Chapter 16. These men simply find the appropriate and safe weight for their skin and continue to use this device throughout the final stages of their program.

### Initial Joys of Stage III

The fact that you have continued your restoration program to the point of discovering the best expansion device for your use is a good indication that you will, in all probability, complete the restoration of your foreskin. It also means that you have for all intents and purposes cleared the last real hurdle: finding a comfortable and effective expansion device.

**1. The Discovery of the Best Expansion Device for You.** After the relative ease of Stage II, the very idea of wearing an expansion device inside your developing foreskin can take a bit of getting used to. Therefore, the first real accomplishment, often accompanied by a sense of both pride and relief, is the actual discovery of a device that is both comfortable to wear and workable in terms of your life style.

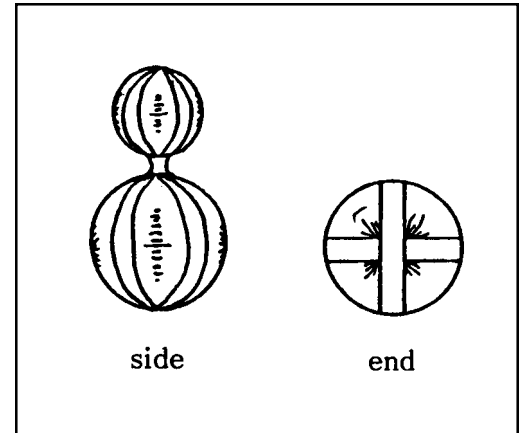

Figure 17-9 Two views of finished device

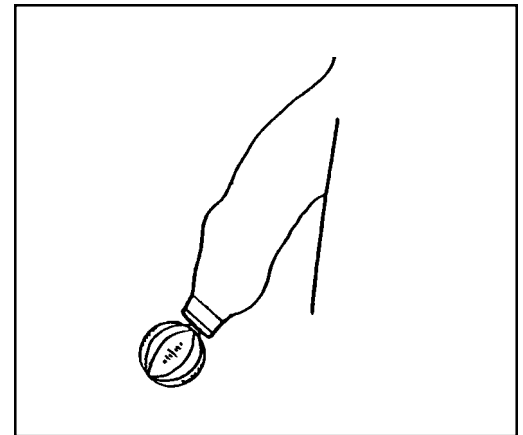

Figure 17-10 Inserted bearing device

## Men's Voices...

circumcision was done away with at the time of Christ and should not be practiced any more by Christians. The conversation went on quite a while with pro and con arguments from the adults. I didn't have any opinions at that age, except that I really was envious of my friends' uncircumcised status!

I married at 21, had twin boys (one was stillborn), a girl, another boy, and another girl. Had I known then what I know now, I certainly would not have had my boys circumcised. I was divorced about eight years ago.

Being single now and being a very sexual person, I enjoy sexual activity as often as possible. One day, I was browsing some reading material and came across information about NOCIRC and the BUFF method and began to think about foreskin restoration. I did a lot of research.

In September 1987, I decided to start some form of restoration. I ruled out surgery. I tried the strap-over-the-top method for a week. But I felt I had too much loose skin and nothing was happening. I am somewhat impatient. I tried using a half-inch tape ring (at the tip) and benzoin. The benzoin irritated my skin somewhat and the half-inch tape was too awkward to remove.

I started cutting the tape to one-quarter-inch strips. This served me much better. I used about six inches or so of tape. I start halfway around on the bottom side, go around and back over the tape. I fold a piece of the end of the tape on itself to make a tab to facilitate removing the tape ring. I had to switch to wearing boxer shorts.

When I urinate, I release the tape past the area of the urethra so that I can retract the foreskin. I have tried urinating with the foreskin forward, however the fuss of blotting up so as not to dribble later is inconvenient at a public urinal. In a letter from a friend, I was told that someone had used a marble to add stretching and weight. As a construction inspector, I went to the ball bearing supplier and got two stainless steel ball bearings. One is one inch in diameter and the other is one and one-quarter inches in diameter.

*(continued)*

**2. Getting Comfortable with an Expansion Device.** There is no getting around it, getting used to wearing an expansion device takes time and patience. Another of the real joys of this stage, then, is the first time you forget you're wearing your device. Men often say that they have become so accustomed to wearing their device that they sometimes have to discreetly feel to remind themselves whether or not they have it on.

**3. Picking up Speed.** One of the topics which often comes up at NORM meetings is how fast a particular individual has learned to step into a stall in a public rest room, whip off the tape, extract the device, urinate, replace both the device and the tape, and be on his way! You really will be surprised, compared to the first few days or weeks of wearing a device, just how speedy the process will become.

**4. The Additional Coverage of the Glans.** At every stage of the system, the additional coverage of the glans is the real payoff. By the time you are wearing a device comfortably and regularly, continuing gains in the length of your new foreskin will have become a regular part of your program. Such gains never fail to give pleasure!

## Homestretch Joys of Stage III

As Stage III progresses, questions such as how much further to go, how much skin is enough, how natural does the new foreskin look, etc., begin to surface. These are nice 'problems' to have—especially when compared to the old ones like how to cope with tight or even painful erections and what to do about a dry, insensitive glans. Before considering some of the final decisions which will need to be made, however, let's look at some of the real joys near the end of the program.

**1. 'I Did It.'** This sense of accomplishment is pretty hard to beat. Not only have you seen a long and sometimes tedious program through to the end, you have done something that only a relatively few men in history have done—you have reversed your circumcision; you have restored your foreskin! Even if you are still not quite finished with your program, there is the realization that your goal is in sight. You really will finish the course!

**2. Going Public with Your New Foreskin.** Many men find that, as their glans is more and more covered, they can leave their device and tape off for selected periods of time. This means that they can go to the gym or play a game of golf where they may well be showering and changing with other men without anything on their penis and appear quite natural.

**3. Getting 'Mistaken' for an Uncircumcised Male.** I have already mentioned, in Chapter 13, my 'restored' friend whose doctor

noted that he did not see many men in my friend's age group who had not been circumcised. I don't need to tell you what an ego trip that remark was for my friend!

**4. Regained Self-Esteem.** For those men who have consciously felt mutilated or victimized by circumcision, the sense of wholeness which their restored foreskin gives them is notable indeed: They took charge; they got it back; they feel whole! This sense of regained wholeness is a factor in every modern victims' recovery program. Circumcision does indeed produce victims. Uncircumcising does provide a real impetus toward recovery.

**5. Sexual Delights.** For most restored males, sex has never been better. This is particularly true for men who were circumcised as infants. These men are experiencing sensations and pleasures they have never before known. The joys of foreplay and pleasuring have certainly taken on new dimensions. And intercourse itself is more natural than it has ever been before. These men have learned firsthand why nature put a foreskin on the human penis!

### How Long Does Stage III Take?

This truly is a question which only you as a restoring male can answer. And the answer is largely governed by the goals you have set relative to your restored foreskin. I would like to point out, however, as a psychologist, that I believe it is wise to set a goal, determine a point of completion, and end your program. As with any other long-term regimen, such as working out, jogging, etc., you could become a 'restoration junkie.' And the last thing any of us wants to do is to confirm the pessimistic conclusions of some doctors that the men who seek foreskin restoration are all disturbed individuals obsessed and preoccupied with their penis and missing foreskin. At some designated point, it is wise to conclude your restoration program and get on with the rest of your life.

### Setting a Final Goal

There are several factors which bear upon the question: When is enough, enough?

**1. Length and Style of the Natural Foreskin.** Like noses and ears, foreskins come in a wide variety of sizes and shapes—nature is like that. In the adult, the natural foreskin may cover the entire glans, or it may cover it only halfway even when the penis is completely flaccid. Some foreskins are long enough to cover the glans completely during a full erection while others retract behind the glans immediately upon erection. While restoring a foreskin may give the individual some say in the final length of his restored foreskin, it seems

### Men's Voices...

I took tape and hung the two balls together, with a quarter-plus inch space between them.

I wear Levis to work in the field and although 'everything' is in plain view, no one has noticed or said a thing. During the day, I have this tandem weight suspended from my new foreskin. I used this device for about a year, five days a week. Together, the two ball bearings weigh about seven ounces. On occasion, I have had some discomfort and removed them. It has taken a little practice to get the tightness of the tape ring just right, so that now I can go all day with it in place. At night, I only have the tape ring on.

I always remove the device to urinate, and with the long tape ring it is easy to put them back in place. Only once did I have the tape give way, in an elevator filled with men and women. I was standing in the back corner and I grabbed my thigh and turned and reached down inside my jeans to recover them before they hit the floor.

Another incident happened in May 1991 while standing in the doorway of an associate. I could feel the tape giving way and the device slipping down my leg. I quickly turned aside into the passageway. Thank goodness no one was walking down the way. The device dropped to the floor. I picked it up quickly and put it into my pocket. My associate asked with much concern what was wrong. I replied that nothing was wrong, that I just had a hole in my pocket and something had dropped.

After the first two months, I was able to keep my 'new' foreskin in place, when the tape had just been removed. If it was after a shower, when I had cleaned the glans, the foreskin did not want to stay in place. Now, however, when I am flaccid, I can keep the foreskin forward over the glans.

I must say that the feeling of having my glans protected is a satisfying feeling, much more comfortable than I ever imagined it would be. Now when the foreskin is retracted, my glans is sensitive enough to feel naked and uncomfortable.

*(continued)*

## Men's Voices...

My foreskin now extends beyond the tip of my glans about three-quarters of an inch. Now although it does not stay forward when erect, there is enough skin to pull over the glans and have it remain there temporarily. I have started to use the device again most of the working week. I know that with some more stretching I will have enough overhang to have it remain always in place when flaccid, or have some minor contouring surgery to tighten the orifice."

R. Wayne Griffiths, California

"I am taking the liberty of writing to you regarding my interest in networking with men who are restoring their foreskins.

I have been stretching seriously about 18 months. I have been using a tape ring for almost two months and have just started using cotton balls under the 'foreskin.' This can be worn 24 hours a day. Erections while sleeping occasionally are uncomfortable, with some 'abuse' on the tape edge closest to the base of my penis. This seems to happen less as the stretching progresses. Attending your support group for men who are stretching obviously isn't going to be possible for me but I would like to join and share what I can with yourself and the group. Do you stretch your foreskin manually while untaped during dormant periods? Does this really indicate where you are at in the stretching process?

Any new, innovative techniques or devices would be sincerely appreciated. In particular, I am looking for extension devices that are either ready-made or easily made and inexpensive."

B.F., Montana

Editor's Note: Since this letter first appeared, several new devices have become available (see Chapter 18).

important to note that nature certainly does not make them all alike. That simple realization may help you not to become too set on a particular style of foreskin and may help you enjoy a truly natural looking foreskin on your penis much sooner than otherwise would be the case.

**2. Genetic Factors.** The intended length and style of your original foreskin were determined by genetics. In most cases, circumcised males who seek restoration report that they want 'their' foreskin back. Obviously, men circumcised as infants cannot know what that would have been. On the other hand, sometimes there are clues. I know one man who is restoring his foreskin and is using what he remembers about his father's foreskin as his model. In his case, that means a very typical length and style of foreskin with the tip of the glans exposed even in the flaccid state. All things being equal, such reasoning on genetic grounds seems quite valid. As a matter of fact, that individual was very tightly circumcised as an infant and now, after four years of restoration, has just about reached his goal. His foreskin, indeed, looks quite natural with the tip of his glans slightly exposed when flaccid.

**3. Sensitivity of the Glans.** As noted often in this book, nearly all males who restore their foreskin report an increase in the sensitivity of their glans. This feature, however, also varies on an individual basis. Some men report that they want to *completely* cover their glans because any part of it which is now exposed to clothing, etc., is uncomfortable. For these men, then, on a rather practical basis, a somewhat longer foreskin is the goal.

**4. Aesthetic Features.** Some men consider a particular aesthetic feature important. Frequently, these men want a tapering overhang in the manner of the classic Greek statues. This can be a problem since even many natural foreskins do not have this feature. Reducing the size of the orifice of a gaping foreskin, particularly a restored foreskin, requires surgery. We will discuss the pros and cons of surgical touch-up procedures in Chapter 19.

**5. Excessive Retractability.** The one feature of a restored foreskin which gets the most complaints is that it often retracts too easily. This can be partially overcome by expanding a relatively longer foreskin. Indeed, some restored males report that, at some point, their new foreskin simply began to "behave." For some of these men, that fact settled the question of when to end their program. Other men choose to have a surgical reduction in the orifice of their new foreskin, not so much for style as for the practical fact that they want their new foreskin to remain in place over their glans at all times, at least in the flaccid state. Again, we will consider surgical touch-up procedures in Chapter 19.

**6. Sexual Manipulation and Pleasure.** For many men the increase in sexual pleasure of having a foreskin has always been their primary goal. Often these men do not want to stop their expansion program until they have enough foreskin to easily stroke over the entire glans with an erection. While such a goal may be obtainable, it seems important to note that many men report that their new foreskin provides a delightful degree of natural stimulation and the gliding mechanism during intercourse long before their new foreskin is as long as some men envision. Again, realistic goals seem wise.

**7. Psychological and Emotional Considerations.** While I do not agree for a moment with those who maintain that men who seek the restoration of their foreskin are all psychologically disturbed, I do agree that there is far more to life than regaining one's foreskin. It is clearly a worthwhile endeavor to do that which can be done to restore and regain a sense of wholeness relative to such a psychologically significant body part as the male's penis. But, balance and harmony are valid principles in life. When the job is done, it is wise to move on to other pursuits and to enjoy the benefits of your commitment, patience, and achievement.

## **Conclusion**

The basic considerations, procedures, and devices presented in the last four chapters have become relatively standardized for the three stages of the nonsurgical skin-expansion system of foreskin restoration. In the next chapter we will look at various alternatives and innovations which have been used and submitted by individuals who are themselves restoring their foreskin.

## Alternative Skin-Expansion Innovations: Do-It-Yourself and Manufactured

**NOTE: This chapter is presented here as in the original publication. In 1992 this information was the most current thinking about foreskin restoration. Since that time, a number of additional methods and devices (both home made and commercial) have become generally available. At the same time, some manufactured devices/methods discussed in this chapter are no longer available. For more current information, see the National Organization of Resorting Men [www.norm.org](http://www.norm.org).**

### Men's Voices...

"Thanks for the prompt reply—very informative literature. It always amazes me that so many people are into this and the reasons people are doing this. I was circumcised at the age of slightly less than one year. My remembrances of being intact are still vivid; I don't know why since I was so young. I somewhat remember the procedure of being circumcised. The sensitive areas of my corona were constantly being rubbed by clothing. My mother insisted on briefs. I spent my childhood in misery. The pain was constant. I can remember the uncontrollable nerve ending stimuli every time I moved about or sat in one position for any length of time. I was labeled as a hyperactive child. (I often wonder how many more little boys this has happened to?)

At the age of 18, I began pulling the foreskin to cover my penis enough that I would wear briefs that would hold everything together. This I did until I recently found out about the stretching techniques that UNCIRC suggests. I have been doing this for some two years now. I have tried several variations.

At first, I used the simple tape method. I had enough foreskin that this was fairly easy to do. I then experimented with small 'O' rings and tape—not very satisfactory. The tape irritated the skin underneath. I also tried the use of tape along with cotton balls. Not only did I get the same irritation but also had wet cotton balls to contend with. Again, not satisfactory.

Tape has one great disadvantage. If you are sexually active, the process of taping and retaping

*(continued)*

The nonsurgical skin-expansion system presented in the last four chapters has evolved into a fairly stable pattern of stages. It is based on relatively simple procedures using tape to hold the penile shaft skin in a variety of positions which will produce sufficient tension to result in skin expansion. In the latter stage, a simple device is used to continue the expansion process.

There have always been, however, those men who have not stuck to the standard procedures or materials in their own restoration program. For some of these men, the search has been for methods or procedures which do not require the use of tape. For others, the search has been for alternative materials from which to make the needed expansion device for use in Stage III of the system. And for still others, the search has been for methods or devices which could be designed, manufactured, and made available to those men who are not comfortable with the do-it-yourself approach. In this chapter, we will consider several alternatives and innovations suggested by men who have found them useful, as well as four manufactured products for those men who prefer 'ready-made' to 'do-it-yourself.'

Not all innovations which have come to our attention at UNCIRC will be presented here. Procedures which involve the use of clamps, excessive weight, piercing, etc., are not recommended and have been omitted. As circumcised males, enough harm has already come to our penis. In my view, any restorative program or procedure which is undertaken should seek only to restore, as nearly as possible, the natural state and should not entail risks of any additional damage to the penis. Further, it must be noted that the information presented in this chapter is intended only to share the ideas of participating individuals or manufacturers and is not presented as tested, proven, or recommended methodology.

### Do-It-Yourself

From the simplest idea—wearing a tape ring 24 hours a day in the hope that nocturnal erections will eventually provide all the tension needed

for complete restoration—to methods so intricate that they take three or four typewritten pages plus diagrams to explain, scores of men have written to share their ideas, methods, and devices. In most cases, the procedures discussed in this section are a composite of the ideas of several individuals which have been combined to give general guidelines for a *type* of method or device.

### A ‘Hands-On’ Procedure

I have met two different men who have completely re-covered their glans by use of a manual ‘pulling’ or ‘stretching’ exercise. Neither of these men used tape or an expansion device of any kind at any point in their program. They simply regularly stretched and manipulated the shaft skin for several years until it elongated enough to re-cover their glans.

One of the fellows, I’ll call him Don, worked for three years to complete his program. His routine went something like this: For two or three minutes, he stretched his shaft skin as far forward over his glans as possible. He then took hold of the skin near the hairline and pushed the skin forward and let it slowly slip through his thumbs and index fingers, exerting only enough pressure to cause tension but no pain. After he worked around the entire penis in this fashion, he then inserted his index fingers into the opening of the skin held over the glans and gently pried outward to stretch the skin in that direction, as far as possible without pain. He stretched and tugged on his shaft skin in this fashion for three to five minutes when he awakened in the morning, each time he urinated throughout the day, and again at bedtime. After three years of this routine, his glans was completely covered (1).

Don and the other case which I mentioned in Chapter 12 are the only two men known to me who have restored their foreskin by simply pulling regularly on the skin. But, for those men who cannot tolerate tape on their penis or whose life style simply will not allow them to wear tape or a device on their penis, this approach certainly warrants consideration.

Before leaving the subject of manual stretching, it should be noted that many men report that they are including some routine of manual stretching as part of their overall restoration program. Also, several intact males have indicated that they are elongating their natural foreskin by this method.

### Retention Rings

Some men have enough skin, either after initial skin expansion or due to a loose style of circumcision, to pull the skin forward and hold it in place in front of the glans by some other means than tape. The implement of choice is typically a ring of some sort. Trial-and-error fitting is generally required. The ring must be large enough around to

### Men’s Voices...

is almost as distracting if not more so than the use of birth control devices—the foam, the diaphragm, the trips to the bathroom to prepare for the event. Add the tape removal into this and it’s not very spontaneous as you probably know.

I am using an O ring for just these reasons. I have found out that, like taping, finding an O ring is necessary. Obviously, this would not work well with someone without enough foreskin to produce the proper results using the O ring technique. By pulling the foreskin from the underneath side with my thumb and index fingers, I can form the same basic effect as a ‘tuck.’ With this done, I then place the O ring over the resultant closure and release. The foreskin retracts enough to hold the O ring in place. With a thin ring, some roll is possible, but I have found this to be an advantage especially in the case of nocturnal erections. The ring is not restrictive enough to cut off blood flow if it is pulled backwards during the erection and, if the ring falls off, replacement is quick and easy. I often replace it, literally, in my sleep. Very rarely is my glans exposed for any length of time.”

L.G., New Orleans

“I have been stretching now for about 1 1/2 years with slow, but fairly good results. I have achieved full coverage, but it still retracts after a while. I have also been given an excellent homemade stretching device invented by an acquaintance who has had excellent results with it. I use it occasionally myself. It can be made simply at home.

I would like to receive any information that you may have on other stretching techniques. I have also contemplated surgical restoration, but have been put off by reports of bad results.”

T.V., Delaware

“Enclosed in this letter is a little invention that someone else introduced to me. I have been using this for about one year now with some excellent results. It looks a little small, but of course variations can be made. I find it best to put on while lying down with knees bent and then pushing the foreskin through the large end and applying a little tension on the cork to which I

(continued)

### Men's Voices...

have a string attached. It can be weighted or used with heavy elastics which are then tied around the knee with a velcro strap. I find the weight as the best method. It is suggested that you start with one pound and work upwards. The time involved is usually from 15-20 minutes in the beginning to about one hour. It is of utmost importance that it not be painful and that discoloration not take place. I cannot emphasize this too much. If slight white blister-like skin appears, this usually goes away in about 15 minutes. Before application, I use a water-based skin softener. I have found oil based products too slippery; let the water-based skin softener dry before applying.

In order to achieve a foreskin, I used the UNCIRC method of skin taping before this device. With the above method, I have achieved a good skin stretch but still have not been able to have my foreskin retract to its former position."

Q.M., Hartford

"I am very interested in restoration because I feel I was mutilated at birth. I was in touch at the beginning of the year and they sent me some information on Stage I of restoration. I have completed this phase.

Please furnish whatever materials you have on stages 2 and 3. I believe that I have created such a device which allows it to be worn 24 hours a day and does not have to be removed for urination. Putting some creative energy into action, I used a 35 mm plastic film holder which had the bottom cut out of it. The rounded edge goes against the penis shaft just below the head. I then take the shaft skin and tape it to the film holder. Once this is done, I stuff shredded cotton balls around the base of the head to prevent the rounded edge from touching the penis (use a Q-tip that has the cotton removed as a 'stuffer' to place the cotton around the base of the head). The amount of cotton can be adjusted to increase or decrease the amount of pressure or stretch. I also use cloth tape around the outside of the film holder to increase the total width. I place tape very close to the rounded edge as this also helps to keep the holder from coming in contact with skin."

P.F., Tulsa

allow the skin to be pulled through the ring with comfort but small enough to hold the skin securely. Caution must be used not to restrict the blood flow to the skin beneath or in front of the ring!

Neoprene rings such as those used in faucets and for other plumbing needs are great favorites. For one thing, such rings are available in a multitude of sizes in terms both of diameter and of the thickness of the ring itself. Further, they can be purchased at any hardware store and are very inexpensive. One fellow I know uses two such rings next to each other: the first ring to hold the skin at the appropriate tension and the second to 'lock' the first ring in place.

Other materials are also used to fashion retention rings. One of the most decorative rings I've heard about was fashioned from a piece of antler. Due to the texture of the hollow antler, the inside surface could be polished so as to be absolutely smooth, and the outer surface could be smoothed enough so as not to be abrasive. The wider surface of the antler ring combined with careful fitting provides the individual who fashioned it with a ring which is comfortable to wear and does not easily slip off his skin, especially since he now has a comfortable extension of skin beyond the tip of his glans.

It should be noted here that there are some men who have revived the ancient practice used by the Greek and Jewish youths of tying their skin forward with a leather thong. As with all retainers of this sort, caution must be used so as not to interfere with blood circulation. The major advantages of these retention-ring methods is that the individual does not have to wear tape on his skin, and the retainer can be removed at any time with little or no effort.

### **Tape and Rubber Band "Frenar Band"**

For those who have enough skin to cover the glans, this variation of the tape ring looks quite natural. First, pull the skin forward over the glans and lightly mark the fold (orifice) of the foreskin with a nontoxic felt-tip or ball-point pen. Next, slide the skin back onto the shaft of the penis and place a small (#6 or #8) rubber band around the penis at the orifice mark. Next, place a narrow strip of stretchable tape around the penis, *over* the rubber band. Finally, carefully ease the tape and rubber band out over the glans. The rubber band should now pucker the tape and reduce the orifice enough to retain the skin, nearly closed, in front of the glans.

### **Tape Collar or "T" Tape Method**

Several men have reported using a variation of this taping method. The simplest is as follows:

- 1) Pull skin forward as far as possible over the glans and put one or two small marks with a nontoxic felt-tip or ball-point pen at the fold (orifice) of the 'foreskin.'
- 2) Retract the skin back onto the shaft of the penis.
- 3) Measure around the erect penis at the marks you have made.



4) Cut two pieces of 2-inch tape the exact length to just fit around the erect penis without overlapping the ends of the tape.

5) Fold one piece of the tape lengthwise, nonadhesive side upon itself, such that approximately 1/2 inch of the adhesive side forms a band, which is then applied around the penis at the marks. There should now be a 1 1/2-inch collar of tape around the penis with the adhesive side exposed.

6) Apply the second piece of tape, face to face, onto the first tape around the penis. When properly applied, 1/2 inch of the second tape will be applied to the shaft skin (on the other side of the marks you made in step one).

7) Carefully pull the resulting 1 1/2-inch, double tape collar forward over the glans as far as is comfortable and attach any sort of weight or tension device as though the collar were an extension of the shaft skin itself.

This tape-collar method has the advantage of allowing the use of weights or other tension devices before the individual has enough skin to actually cover the entire glans. A more sophisticated version of this taping method is incorporated into the Evans Industries Restore-Skin System discussed later in this chapter.

### **Tension Devices**

In 1992, when I first wrote the chapter on expansion devices, those which used elastic bands to pull the shaft skin out over the glans were dubbed “early expansion devices.” It seemed at that time that such devices were a thing of the past—but not so! Several men and one manufacturer (Evans Industries) have not only resurrected elastic tension but have refined the procedure considerably. The motive: 24-hour-a-day tension for men who sit for long periods of the day and, therefore, find weights relatively ineffective.

The elastic band is generally made from either ordinary elastic found in fabric shops or from modified suspenders. The band is typically attached to the penis in one of two ways (see below) with the ‘other end’ attached in various configurations: 1) down one leg with either a loop made to fit around the foot or clipped to the inside of the top of the sock, 2) down one leg to a garter worn below the knee, or 3) up over one shoulder or around the neck and down to be clipped to the band of one’s underwear or trousers. The up-and-around-the-neck configuration is worn by several men at night and is reported to be quite comfortable in terms of nocturnal erections, depending on how the band is attached to the penis:

**1. Attached to a Device.** Some men prefer to attach the elastic band to a hollow device to which the shaft skin has been taped. These devices are made of such materials as Friendly Plastic (see below), PVC pipe (especially the flared end designed to join two lengths of 3/4-inch pipe), or a variety of small ‘tubes.’ Whatever the material, all edges must be smoothed, and the device must have a means by which to attach the elastic band. Because these devices are all cylindrical, urination through the device is typically not a problem.

**2. Attached to Tape Only.** The tape collar discussed above is a favored implement to which to attach the elastic band. A variety of tape-only methods have been reported from simple, extra-large Band-Aids to very elaborate tape ‘harnesses’ which offer a high degree of adhesiveness and can be worn for several days at a time.

By whatever means the elastic band is attached at its two ends and in whatever configuration the band is worn, it seems likely that the use of such tension devices will continue to increase in popularity, spurred on by the sedentary life style common to so many of us.

### **Custom-Made Extension Devices**

In the final stage of their skin-expansion program, many men express a desire to find or fashion an object to be worn within the developing foreskin which will comfortably fit the glans and will provide the tension needed to continue the expansion process. As noted in Chapter 17, the simple objects adapted for use within the foreskin have been many and varied. But most of them actually do not fit the glans in any tailored or comfortable way.

There is a product now on the market which allows the individual to design and fashion his own device with no other tools or know-how than hot water and his own two hands. The product’s name is Friendly Plastic. It is available in most art and stationery stores. It comes in both sheet and pellet form. The pellets are much simpler to work with and are considerably less expensive.

Friendly Plastic is simplicity itself to work with. Place the pellets in a heat resistant, non-aluminum bowl (the plastic does not stick) and pour near boiling water over the pellets. Wait for about a minute, and pour the water off. You can then shape an object of your design until the plastic cools. At that point, areas of the object can be softened for further shaping by simply holding the device you are making under hot running water from the faucet.

If you are really dissatisfied with your first attempt(s), simply put the device you've been working with back into the bowl and, with near boiling water, melt it down and start over again. This product can be remelted as often as needed, so there is ample opportunity for practice.

After you are finished fashioning the device, let it cool completely. The device can then be sanded and further shaped in its rigid state. When the device is the size and shape you desire, it can be thoroughly smoothed by a quick dip in hot water again. Slightly warmed, this plastic can be rubbed with wet fingers to produce a very smooth surface. Some men have used this product to make cones of both the solid, removable style and the hollow style which allows for urination. Obviously, a cone made of Friendly Plastic is rigid and must be fitted and worn with care. All edges and surfaces must be smooth, and there must be no restriction of blood flow. When made and worn with proper care, however, the devices made of Friendly Plastic have been used with great success by any number of men, several of whom have sent in drawings and even samples of their designs.

### **'Musical' Devices**

It has not gone without notice that the mouthpiece of a number of the larger brass musical instruments are remarkably suited for modification to be worn comfortably within the developing foreskin. Tuba, trombone, and Sousaphone are among the mouthpieces suggested. The men who have sent in suggestions for using such a mouthpiece all modified them by grinding away part of the stem, some of the flare of the mouth orifice, or some other unwanted feature. In each case, the design of the original mouthpiece allows for urination while wearing the device. Typically, either a weight or elastic tension is attached to the protruding stem of the device once it is taped in place within the foreskin.

### **Regained Sensitivity of the Glans**

Dr. Dean Edell, a nationally syndicated radio talk-show physician, reported the case of an 80-year-old circumcised man who sought to regain the sensitivity of his glans. The gentleman stated that he had become completely impotent. In an effort to protect his exposed glans from dryness and abrasion, he began covering it with Saran Wrap. After using this procedure for some time, he had regained both the sensitivity of his glans and sexual function!

While most men will want their glans covered with natural skin rather than a man-made product, this story demonstrates once again that a covered glans is a happy glans—even at 80! (2). It further demonstrates the extent to which some men will go to regain the natural sensitivity which circumcision has destroyed.

### **Manufactured Devices and Methods**

Throughout this book, every effort has been made to present information, describe materials, and give simple instructions such that the individual can decide on a course of action and carry out an individualized restoration program using the simplest of ideas and readily available materials. On the other hand, from the earliest days of the modern-day restoration movement, numbers of men have expressed the desire for ready-made devices and products which do not require design or assembly skills. The earliest such device (1991), designed by R. Wayne Griffiths, is a prefabricated version of 'stainless steel ball bearings in tandem' (see Chapter 17). For those interested in the ready-made devices and methods which are currently available, the following is a brief description of three manufactured products known to me. Again, it must be noted that these products are described here for information purposes only and not as an endorsement (for further information, see listings under RESOURCES).

### **Restore-Skin System**

The kit provided by Evans Industries contains: 1) an instruction video, 2) 100 peel-off tape devices (available separately and in a variety of tapes), 3) leg, shoulder, and waist straps, 4) a 'tape-off' lotion which removes both the tape and adhesive residue (available separately), and 5) printed instructions and a record chart.

As noted earlier in this chapter, the peel-off tape device provides a ready-made tape collar which can be worn for several days at a time. It is easy to urinate with the tape device in place, and the device can be removed quite easily with the lotion provided. In addition to the restoration kit, this manufacturer has produced, to date, three additional videos dealing with various aspects of circumcision and restoration.

The advantage of this system is that there is virtually no do-it-yourself element. Everything you need is provided, and the procedure is both illustrated and demonstrated in the video. The main disadvantages are those

shared by several of the procedures described in this book: 1) The rather bulky and obvious tape collar requires privacy in public rest rooms, and, 2) when worn for several days at a time, its removal must be anticipated relative to sexual activity.

### **Polyurethane Elastomer Cones**

These semisoft cones come in a set of three, in graduated sizes. They are available in either weighted or nonweighted versions and are drilled so that they may be worn continuously and urinated through. Some men prefer to wear these cones entirely within the foreskin and to hold them in place with a relatively loose tape ring, while others prefer to tape the skin directly to the cone at whatever point on the cone is most comfortable.

A major advantage of these cones is that the material from which they are made allows ease of cleaning and drying such that they can be used continuously, unlike do-it-yourself foam cones which must be removed for urination and washed and allowed to dry regularly. The one disadvantage of these cones is that they are currently manufactured with a one-size-fits-all chamber for the glans. As a result, some men find the fit 'just right' while others have been unable to use the cones because the chamber does not fit their glans comfortably.

### **Stainless Steel Device in Various Weights**

American Bodycrafters, Inc., has developed an uncircumcising device of high-quality stainless steel. It has a funnel-shaped chamber which fits over the glans and is worn inside the developing foreskin and a larger, cylinder-shaped body which extends beyond the penis to provide the necessary weight. The device is available in a range of 'cup' sizes for the glans and a variety of overall weights ranging from 10-22 ounces (although, in my

opinion, weights above 10-12 ounces should only be worn after some experience with the device). The device is drilled with a generous channel from the bottom of the glans cup out through the tip such that urination through the device is quite easy for most men.

The advantages of this device are: 1) the high quality of the material, 2) the narrow 'neck' which minimizes lateral expansion, and 3) the variety of sizes and weights to meet individual requirements. The disadvantages are: 1) It must be applied and removed daily since it should not be worn during sleep. This means, of course, that the individual must find a tape which he can remove daily without harm to his skin. 2) It is bulky when added to the length of the penis. This fact has led to complaints that the device is quite visible beneath many styles of clothing and that it swings and can hit vulnerable anatomical structures when one moves too quickly or is running. Be that as it may, this device is certainly popular, effective, and of handsome design.

### **Conclusion**

No doubt, the years ahead will bring the development of other devices and the availability of other products and materials suitable for use in restoration programs. Hopefully, descriptions of such devices and products will continue to be submitted to UNCIRC so that as much information as possible can be made available to men who seek to restore their foreskin.

No matter what program or device is used, most men wish that the opening of their restored foreskin were smaller and tighter against the tip of their glans. In the next chapter, we will consider the techniques known so far to this author and the pros and cons of surgical touch-up procedures used to contour the restored foreskin.

# 19

## Finishing Touches to the Restored Foreskin

*“Needing to make these decisions (selecting my finishing touches) is a nice problem to have.”*

**R. Wayne Griffiths**

**NOTE: N.B. This chapter has been retained for historical purposes. The surgical touch ups suggested here have *not* proven successful in most cases. Therefore, it is suggested that the individual continue the restoration process until sufficient tissue has been produced to effect more reliable coverage of the glans.**

### Men's Voices...

“I have contacted you in the past and received a prompt response on questions about stretching. Thanks. After several years of stretching, there comes a time when one wonders about the narrowing and who has had it done, for reference and referrals of doctors who have done this. Do you know of anyone who has had the narrowing procedure done and would be willing to share some information? One certainly doesn't want to have a bad job done after looking forward to finishing the stretching procedure. I am at the point of consultation to see if I am ready. Does a regular plastic surgeon do this? I would appreciate where to go from here and to talk to someone in confidentiality on how successful it turned out. I appreciate it very much.”

S.G., Texas

“I have been using the BUFF method for stretching my foreskin for almost three years now. I was completely circumcised at birth, but seemed to have more loose skin on the shaft than other guys who are cut. Therefore I have realized some pretty good success in gaining skin. At this point, I have enough skin to cover the head when soft, but need some method of reducing the size of the orifice in order for it to stay in place. Without this, the skin rolls back and gathers in wrinkles on the shaft. For this reason I am considering having the

*(continued)*

The majority of men who restore their foreskin by nonsurgical procedures will have a foreskin which is apt to retract off the glans more easily and more often than the individual would like. Surgical reduction of the orifice of the new foreskin is the only permanent solution to such a condition. The decision which men with the typical restored foreskin will need to make is whether or not to have a final surgical touch-up procedure or learn to live with their restored foreskin as is. In this chapter, we will look at both options and the pros and cons of the various remedies.

### Living with an Unruly Foreskin

This problem can be a kind of ‘catch 22.’ Having regained a higher degree of sensitivity of the glans, the individual now needs to keep it covered in order to be comfortable. And he now has enough skin to do just that—if only it would stay where it belongs. Unfortunately, a restored foreskin can, and often does, creep back and expose the glans both too often and at inopportune times. There are several things which can be done, however, to help make a restored foreskin behave. The following suggestions have been made by men who have chosen not to undergo a surgical touch-up procedure.

**1. Develop a Longer Foreskin.** As noted in Chapter 17, a longer foreskin does tend to stay in place over the glans more reliably than a shorter one. The advantage is obvious: The individual acquires a better functioning foreskin without any of the risks involved with even minor surgical procedures. On the other hand, expanding the additional length of foreskin may add months, or even years, to an already lengthy process. Further, it seems obvious that there are individual differences in how amenable any given person's skin is to indefinite expansion. At some point, the individual will need to set

realistic goals for himself in terms of the cost in time, effort, and frustration should he determine to develop a long enough foreskin to assure reliable coverage of the glans.

**2. Retainer Ring.** In Chapter 18, we discussed the use of retention rings as an alternative to the use of tape during the later stages of the skin-expansion system. Some men consider it worth the extra effort simply to wear such a ring on a permanent basis rather than submit to a surgical touch-up procedure. A more decorative style of ring such as that made from an antler, also mentioned in Chapter 18, seems especially appropriate for permanent use. The advantage is assured coverage of the glans without recourse to surgery. The disadvantage is, however, obvious. Many men are simply not prepared to wear even a decorative device on their penis on any sort of permanent basis. After all, for these men, the goal of restoration is to appear natural, and in our culture that means a penis without adornment.

**3. Tape Retainer.** When I wrote the first edition of this book, it did not occur to me that a significant number of men would choose to wear some amount of tape on their penis for the rest of their life, if need be, rather than submit to *any* surgical procedure. I have now heard from several men who, after developing enough skin to achieve good coverage of the glans, continue to wear a small, inconspicuous piece of tape (in various configurations) to hold their new foreskin in place over their glans. By this means, these men are able to avoid having their now more sensitive glans rub against clothing and, in most cases, are able to use public facilities without the tape retainer being embarrassingly obvious.

**4. Tighter Fitting Underwear.** Men's underwear styles have changed considerably over the last several years. Among the newer designs are several styles which provide a rather tight, form-fitting pouch. Many men find that they can pull their new foreskin in place over the glans and then hold both the penis and foreskin in place by wearing one of these tighter styles of underwear. The advantages are both low cost and fairly reliable coverage. The disadvantages are having to get used to the cut and feel of rather skimpy, tight underwear and the fact that this means of retaining the foreskin over the glans is neither certain nor foolproof. Further, such a solution does nothing to keep the new foreskin in place while nude in public places such as a gym or locker room.

## Surgical Touch Ups

Each doctor I have talked with has his own favored procedure to reduce the orifice of the restored foreskin. The final choice of surgical procedure is further influenced by various anatomical features of the

## Men's Voices...

surgical procedure to create the slight restriction needed to hold the skin in place over the head.

I have the following questions:

1. Since I want to keep stretching to gain a nice overhang and have a fair amount of coverage when erect, should I continue to stretch it as it is, and what is the best method (as well as convenient) to do this? My progress seems to have slowed a bit, so I am also wondering if there are any new methods, techniques or advice you can offer to help increase stretching at this point.
2. If I decide to have the procedure performed to narrow the foreskin opening, I want the most competent surgeon with experience and expertise in this type of procedure to yield a most natural and functional foreskin (for obvious reasons). Do you know or can you recommend someone who fits this criteria?"

B.C., South Carolina

"I am very interested in foreskin restoration since I was circumcised at six years of age. At the present time I am in a stretching program and would like to know if there is a doctor in Sacramento who I might see for a surgical tuck since I do have skin over the head."

B.B., Sacramento

"At the symposium you mentioned a man who had undergone a tuck. Is it possible to see what he looks like now? As I am doing fine, progress is slow, but I can see results. When I get out of the shower and look at myself naked and my foreskin covers my head, I feel great pleasure. I still wonder if I will get to the point that I think is fine for what I want. Am I going to have to have surgery or wear tape for the rest of my life? I can't wear tape when I shower with other men after playing a sport.

It has been a year since I started and, yes, I have coverage, but I always have to wear the tape. How many doctors do this tuck surgery? In Canada, the doctors have not been too receptive to my taping, so I question further steps I must take."

S.K., Ontario, Canada

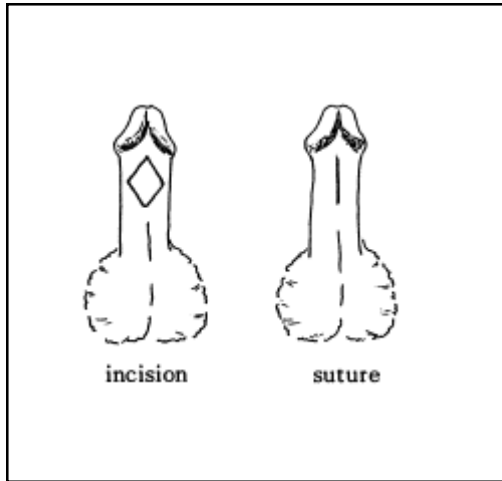

Figure 19-1 Single diamond/underside of penis

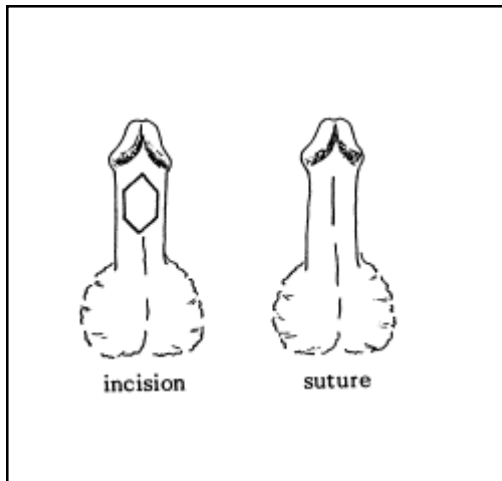

Figure 19-2 Single elongated diamond/underside of penis

individual seeking to better retain his new foreskin over his glans. The following are brief descriptions of various reduction procedures which have been used by or discussed with doctors working in this field.

### Tissue-Removal Techniques

There are several different configurations of this procedure which produce slightly different results. Each configuration involves the removal of small, diamond-shaped sections of skin. The following are some of the patterns suggested by various doctors.

**1. Single-Section Reduction.** This simple removal of a diamond-shaped section of skin is suggested for the individual whose new foreskin is not too long but will cover most, if not all, his glans. Further, this pattern is best suited for the individual who needs relatively little reduction in the orifice of his foreskin (Figure 19-1).

**2. Elongated Single-Section Reduction.** This elongated 'diamond' pattern is best suited for the individual who has a longer foreskin and wishes it to taper out past the glans (Figure 19-2).

**3. Multiple-Section Reduction.** There are doctors who suggest the removal of multiple, smaller diamond-shaped sections to achieve orifice reduction. Some have suggested two reductions at the 4 and 8 o'clock positions or at the 12 and 6 o'clock positions. One doctor I spoke with suggested three reductions at the 12, 4, and 8 o'clock positions. In each case, the intent is to make multiple smaller reductions which will result in the finished orifice having a more natural line.

The advantage of the tissue-removal procedures is that the resulting orifice is relatively flat, smooth, and circular. The major disadvantage is that the procedure involves the actual removal of tissue. This factor, of necessity, requires that a judgment be made as to how much tissue to remove and how effective the final orifice will be in terms of retaining the foreskin over the glans. These are formidable judgment calls to be made while performing a rather delicate surgical procedure.

While UNCIRC and NORM have heard from a few men who have had some type of touch-up procedure, I personally know only one individual who has had a reduction procedure performed. In that case, the doctor performed a multiple-section reduction but modified the design of the incision to resemble a narrow, elongated leaf, symmetrically tapered at both ends (Figure 19-3). He made two such incisions at the 4 and 8 o'clock positions. In this case, the surgery was performed before the individual had enough skin to reliably cover the glans in the hope that tape would no longer be necessary, unless a device were being worn. Due to the early stage at which the surgery

was performed in this case, the newly narrowed orifice frequently slips behind the corona of the glans. Because of this fact, the individual is still working to lengthen his new foreskin. The reduction of the orifice, however, is smooth and natural looking when the foreskin is in place over the glans. Moral of the story: be patient and wait until you have good coverage before you seek a surgical touch up; by that time, you may not need it.

### Transverse Incisions

This procedure involves making a number of short incisions around the orifice of the foreskin and then suturing each incision in the opposite direction (Figure 19-4).

The procedure has the advantage that it does not remove any tissue. Theoretically, a first set of incisions could be made and, after healing, the results evaluated. Later, if the first procedure has not resulted in a sufficiently reduced orifice, a second set of incisions could be made. This feature means that there is considerably less risk of 'going too far' as can happen when sections of tissue are removed, as in the procedures above. The disadvantage of this procedure is that the resulting orifice has a somewhat scalloped appearance and does not lay flat or circular in the neater fashion of the tissue-removal procedures.

### Circumferential Purse-String Suture

One urologist I spoke with favors this procedure. It involves implanting a temporary, but long lasting, suture inside the tissue of the new foreskin. Without the removal of any tissue, the foreskin is pulled into place over the glans and a single, long suture is threaded into the tissue in the style of a purse string. The suture is placed such that it is just up inside the orifice of the new foreskin and is embedded within the *inner* tissue layers of the foreskin (that is, *inside* the penile covering). After the suture is in place, it is tightened so that the foreskin is nearly closed in front of the glans. The suture and the foreskin are left in place for approximately six weeks, during which time the tissue which has been pierced and slightly inflamed by the suture heals to form a somewhat constricted band near the tip of the new foreskin. The intended function of this constricted band is to hug the tip of the glans when flaccid but to expand during erections in the fashion of the frenar band of the natural foreskin as described in Chapter 2.

The advantage of the purse-string suture is that it does not remove tissue and can be installed by a relatively simple procedure. The disadvantages are that it requires six weeks before its effectiveness can be known and, further, that the configuration and size of the new orifice are less controlled by the procedure than is true for other

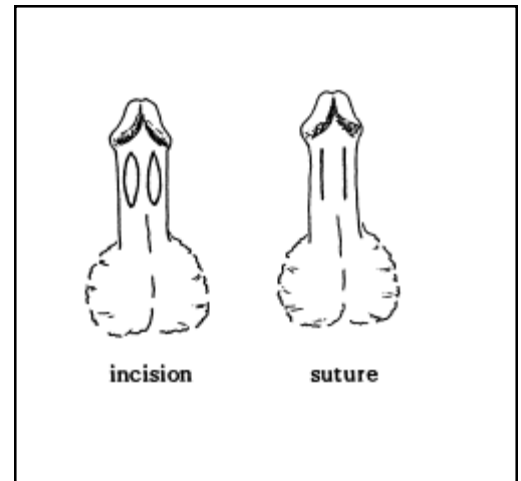

Figure 19-3 Double elongated leaf/  
underside of penis

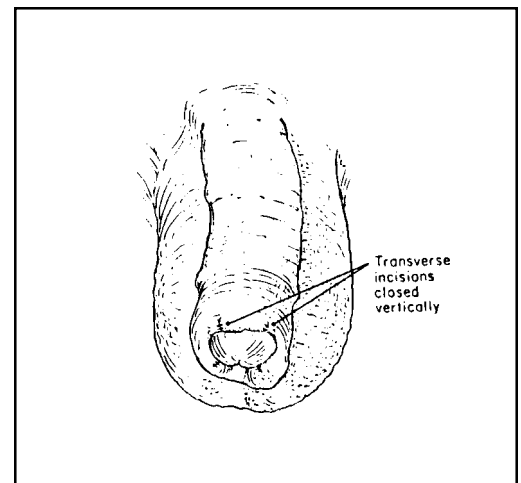

Figure 19-4 Transverse incisions and  
example of suturing

surgical techniques. I am assured, however, by the doctor who described the procedure to me that he has had very satisfactory results using this procedure.

### **Pros and Cons of Surgery Itself**

In presenting the various surgical touch-up techniques, I have attempted to discuss the advantages and disadvantages of each one as compared to the other surgical options. Thus, we have not as yet addressed the issue of the relative advantages and disadvantages of surgery itself. And, in the final analysis, this is a very personal decision. Certainly we live in a day when cosmetic surgery is very accepted and acceptable as an option. Every surgeon I spoke with readily discussed the fact that surgery carries a risk factor. On the other hand, there are features of a surgically contoured restored foreskin which are very unlikely without some such procedure.

The desired results, the cost, the pain, and the risks are all factors which must be considered by the individual before he agrees to undergo a surgical touch-up procedure. Furthermore, one of the biggest deterrents at the present time is the lack of doctors who will actually do these procedures. Admittedly, some of the doctors with whom I discussed the material for this chapter are either retired or not currently working in the field. As with so many other situations in life, supply and demand will no doubt eventually win out. Hopefully, one effect of this book will be to serve as a catalyst to influence more doctors to develop or learn various procedures and make them available on a much wider scale. There are a number of men waiting and asking for doctors to put the finishing touches on the foreskin they have patiently restored.

### **Electrolysis**

While stray hairs on the penis, usually on the underside, are relatively common, tightly circumcised men often find that such hairs have been permanently drawn rather far out onto the penile shaft, particularly during an erection. Further, as a result of skin expansion, some of these hairs may 'migrate' even further out the shaft of the penis, even in its flaccid state. Many restored men find this condition simply an interesting and novel phenomenon and let it go at that. Others prefer to have at least some of the more obvious hairs removed by electrolysis as a 'finishing touch' toward a state of restoration which resembles the natural penis as nearly as possible.

In the next chapter we will look at trends in modern-day surgical foreskin reconstruction.



# Trends and Options in Surgical Foreskin Reconstruction

*“The idea for this technique originated from reconstruction of penile skin....Later it was learned that the method is a modification of an ancient operation described by Celsus.”*

**W.E. Goodwin, M.D.**

The use of surgery to correct the results of circumcision dates back at least to Celsus in the 1st century (1). And, as a matter of record, early articles in respected medical journals, dating from the 1880s and 90s, reveal an abiding interest in, “The Undoing of Circumcision” (2). Further, we have discussed at length the crude procedures used by Polish doctors to help Jews avoid detection under the Nazi regime. The reversal of routine, medical, nonreligious circumcision, on the other hand, is a relatively new phenomenon, as is nonreligious circumcision itself.

In Chapter 12, we traced the historical documentation of modern-day surgical techniques from the pioneering work of Dr. Jack Penn, reported in 1963, to the present. In this chapter we will look more fully at those surgical techniques which have gained a certain acceptance and at other, more recent developments which show promise.

If any single aspect of the modern-day quest for foreskin reconstruction sets this current era apart from earlier times, it is the hope and expectation that the newly regained foreskin will work! In ancient times, and again under Hitler, it was enough to produce a single-layered, nonretractable flap of skin which cosmetically resembled a foreskin. Today, men who seek reconstruction not only want their glans re-covered, they want their new foreskin fully retractable and mobile on the penile shaft; preferably, it should feel like the real thing too. These expectations and requirements mean that the techniques employed by surgeons today must of necessity be more advanced and sophisticated than ever before. We will consider several techniques currently in use and attempt some sort of comparisons and evaluations. Realistically, however, individual characteristics both of the circumcised male’s condition and of the skills and training of the surgeon often limit the range of choices any individual male may have.

**NOTE: N.B. This chapter is presented here for historical completeness as in the original publication. While many men would desire a ‘quick fix’ to regain a foreskin, the trends in surgical reconstruction have not proven sufficiently reliable to date to warrant recommendation. See position statement at [www.norm.org](http://www.norm.org).**

## Men’s Voices...

“I initially pursued having a foreskin reconstruction exactly 20 years ago, in the fall of 1971. I had just earned my B.A. degree in the spring and then pursued something I had pondered for several years. The actual surgery was finally performed at St. Joseph’s Hospital in Chicago, Illinois in August 1972. The ordeal I had to undergo from the time I began my search to have my foreskin reconstructed to the final surgery was a series of negative experiences that would probably have discouraged many others. The rejection, the insensitivity, and the outright hostility in some cases would have discouraged anyone else who was not as highly motivated. I, in turn, developed contempt for doctors and their medical profession. I felt that if the doctor who originally cut me as an infant had simply left me natural, I would never had to undergo the humiliation in so many doctors’ offices not to mention the cost involved. I had been to see plastic surgeons, urologists, psychiatrists, and a G.P. in my search.

I had to see one of the urologists more than once because I had to obtain a letter from a psychotherapist with whom I had discussed this problem. In each case I had to make appointments well in advance and each was always paid his consultation fee for his time. I was told that I was the only one who had ever requested this

*(continued)*

## Men's Voices...

procedure, therefore there was something 'wrong' with me. While speaking with one of the earlier urologists in his office he struck me several times with his fingers on the back of my head and stated, 'There's something wrong with your head.' Was this representative of the medical profession?

I became angered from my experiences but I never became discouraged; I always knew that I was right. I could never believe that I was the only one who hated the idea of being robbed of my foreskin. Keep in mind that this was 20 years ago when there weren't any organizations such as NOCIRC, INTACT, UNCIRC, etc. for normal support. I was completely on my own!

One doctor told me that I'm the only one who has to see it, so I shouldn't be concerned with it. I guess I was supposed to have been comforted by that in some way.

But that was exactly why I wanted the reconstruction, because every time I saw that ugly scar it was a reminder of what was done to me. I always felt that it was a mutilation despite what rationale they have for it. Seeing that jagged scar was a constant reminder of how every bit of my foreskin was not only completely removed, but looking downward at my penis at what would be the nine o'clock position, I could see how an extra notch of shaft skin had been cut out. In their zeal to remove my foreskin, I ended up being 105% circumcised. I hated seeing that dark gash on the side of my shaft. That was why I never became discouraged when doctors told me that there was something wrong with my thinking. Everyone had a decision on this except the person being mutilated. No one ever asked me! For the rest of my life, there isn't a doctor in the world who could ever tell me that I had to be cut up like that.

It should be mentioned that in my desire to have my foreskin again I actually tried the stretching technique on my own long before I learned about it from the BUFF organization. I rolled the shaft skin forward and even taped it in place and went

*(continued)*

Some of the techniques discussed below are complicated, multi-phase procedures which have been documented in great detail. Others are relatively simple procedures which have been adapted for use in foreskin reconstruction. Every attempt has been made to include all the major techniques in use today, although it is not possible to acknowledge each of the surgeons currently doing such procedures. The order of presentation here is roughly historical.

### The Platinum-Ring Implant

I am unaware that any doctor is currently doing this simple procedure. It is included here for three reasons: First, it is this procedure which spawned the entire nonsurgical skin-expansion system. Second, I want to acknowledge the fact that members of the medical profession have indeed responded to the pleas of circumcised men to help them regain their foreskin, and several doctors from the late 70s onward have ventured forth in uncharted waters at the urging of these wounded men. Third, it is interesting to note that the most recent surgical procedures, even now being developed, involve the implantation of devices to expand the skin of the penis before later procedures are used to complete and contour the finished foreskin. It would seem that at least the *concept* may have been valid after all.

The original technique was very simple. The skin of the penis was pulled forward over the glans. The ring was then surgically implanted in the 'tip' of the new foreskin so as to hold the skin in place over the glans. The individual, thus, had 'created phimosis' until the ring was later removed. As noted earlier, the procedure did not expand the skin sufficiently to provide a foreskin long enough to cover the glans after the ring was removed. Furthermore, the implanted ring caused fibrous tissue to form around it such that the individual had a visible, raised fibrous ring within the skin of the penis after the platinum ring was removed. And, finally, the use of this procedure was limited to those men who already had enough mobile skin on the shaft of their penis to accommodate a full erection with the ring implanted. And our information at UNCIRC would indicate that many circumcised males in America would not have sufficient skin to be suitable candidates for such a procedure.

### Z-Plasty Techniques

This technique is among the earliest mentioned and simplest procedures for expanding a tight penile covering resulting from circumcision. It is most frequently used, however, particularly in other nations, as a means of relieving phimosis so as not to resort to circumcision (3). There are, in addition, other related techniques such as the multiple-Y-V-plasties (4). In each case, an incision is made through the penile covering in the configuration(s) suggested by the name. The edges of

the incision are then realigned and sewn together so as to elongate or expand the skin (Figure 20-1).

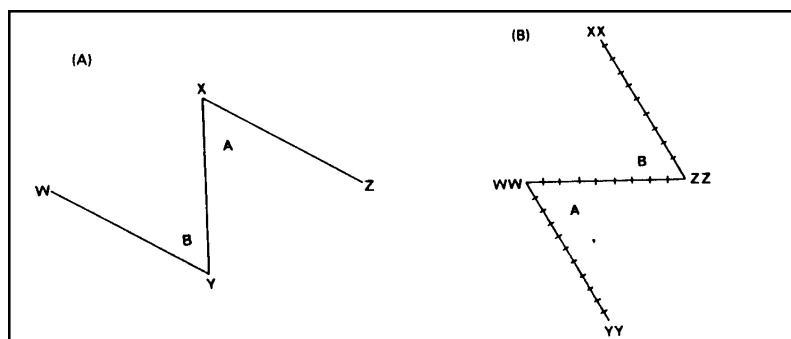

Figure 20-1 Z-plasty. Contracture along X Y is released to XX YY by raising and interchanging flaps A and B

By a series of such surgical realignments, the skin can be repositioned either to extend further out the penile shaft or to provide a wider opening, as in the case of phimosis. Obviously, in the case of elongation, such repositioning leaves areas on the penile shaft where the overall circumference of the penile covering has been narrowed. But, given the effects of eventual skin expansion and with careful positioning of the surgery, additional skin length is certainly possible by this means. Once again, such procedures are most suitable for those who need only limited elongation. Further, the complete procedure may require multiple surgeries. These procedures have the great advantage, however, that no skin from other locations on the body is used, and, thus, the problem of mismatched skin is avoided.

### Free-Graft Procedures

The term, free graft, refers to the fact that skin is taken from a hairless, donor area of the body, usually the buttocks or the underarm. It is then 'transplanted' to the shaft of the penis in order to expand the overall length of the penile covering. This procedure can require a series of grafts in order to produce a penile covering of the length required to re-cover the glans.

**Dr. Jack Penn (1963).** Dr. Penn's procedure has been fully described in Chapter 12. I mention it here both for the sake of continuity and because each of the other known free-graft procedures are in fact simply variations on his early work.

**Foreskin Reconstruction in Australia.** It is not easy to keep up with the various reconstruction procedures in a nation the size of the United States, let alone in other nations which also have a history of infant male circumcision. On the other hand, at least two cases of free-graft reconstruction in Australia are documented in the files of NOCIRC.

### Men's Voices...

about my business like that. I eventually rejected the method because I reasoned that there would never be enough skin to stretch far enough to create a permanent new foreskin. After all, something had been removed. I would still need some surgical procedure to retain the foreskin in its proper position covering the glans. Consequently, I felt that a surgical reconstruction was the only answer. It had taken a surgeon to do the damage originally so I concluded that it would take another surgeon to undo the work of the first.

A later urologist said that he would send me to a psychologist for a battery of tests but he wanted nothing to do with me after that. I was somewhat of a leper to him. I took all their tests (Rorschach, projective tests, pencil and paper tests, word association and verbal response tests, etc.). After all the testing, the psychologist wrote up his summation and the results were sent to a prominent psychiatrist here in the Atlanta area. I was then referred to him and I had to set up an appointment to discuss the results. Much to his amazement, he was shocked to find that I was not all psychotic, out-of-touch with reality, or had something 'wrong' with my head. In fact, he stated that the testing showed that I had a lot of very good character traits and qualities and I wasn't what they expected. Surprise!

I naturally resented this long and expensive ordeal because I never felt my request was strange. I only wanted to be how nature intended me to be. I don't think I would have been treated that same way had I always had my foreskin and wanted it surgically removed. This psychiatrist in turn referred me to another plastic surgeon.

I was in the hospital for a total of ten days. It was yet another plastic surgeon who ultimately did the work. A catheter was placed in my urinary tract so I would not be touching the graft during the healing process. The graft site was from my right hip.

The only regret I've had regarding my reconstruction was that the grafted skin area was of a different coloration than the penile shaft skin. The technique they used was to slip most of the

*(continued)*

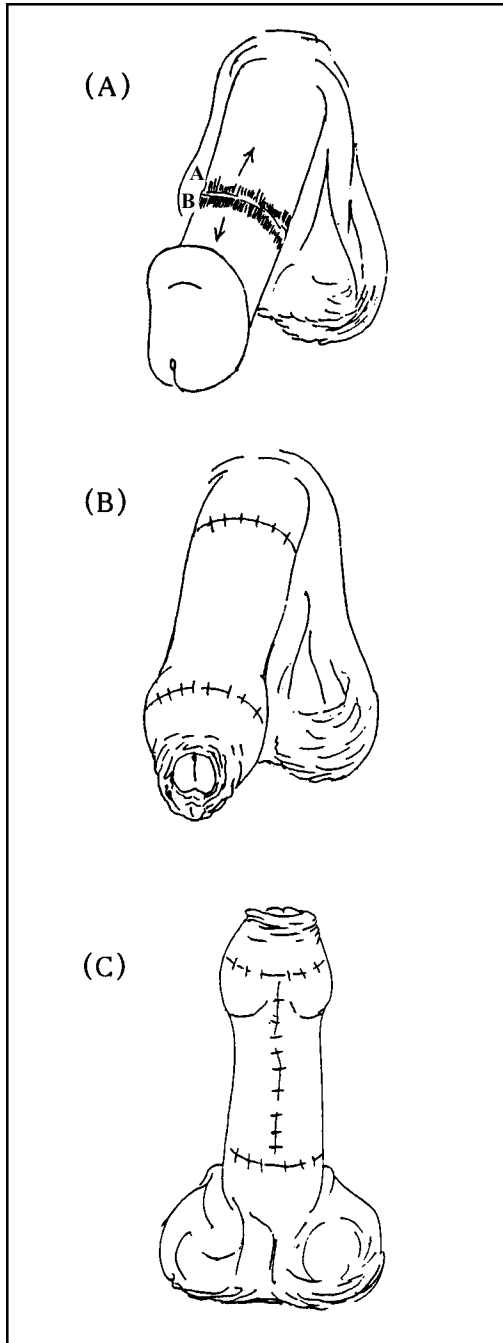

Figure 20-2 Australian free-graft procedure. Circumcised penis (A); original circumcision scar opened up; donor skin 4" x 6" taken from patient's buttock and wrapped around between edges of cicatrice A & B and sewn together (B). Third edge of donor skin sewn on underside of penis to be less conspicuous (C)

In each case, the penile covering was incised around the shaft of the penis and a graft used to fill in the gap which resulted when the anterior (front) portion of the original skin sheath was pulled forward over the glans to form at least the inner lining of the new foreskin (Figure 20-2).

In one documented case, the graft was taken from the buttocks and in the other from the underarm. In both cases, the grafted tissue is a very different color (lighter) than the original penile covering, and the texture and appearance differ greatly as well. Other problems encountered with this method are 1) reduced (or no) feeling in the graft and 2) difficulty achieving an ease of mobility of the graft on the penile shaft. And, in one case, there was also noted shrinkage and lack of suppleness of the graft itself.

For all of these rather obvious shortcomings, one of the 'restored' Australian men reports:

I am now the proud owner of a fully restored, average-length foreskin, which will never be as good as an original, but definitely the next best thing. The feeling is fantastic, and despite the scars (that have almost faded) it looks and functions really well. Having been both cut and uncut, I can only say that anyone who parts with his foreskin is giving up the best part of himself. I would not part with my reconstructed foreskin for anything (5).

Finally, UNCIRC has received a very interesting piece of information from a man who had a free-graft reconstruction in the early 70s. To solve the cosmetic problem of a lighter colored graft, this individual had flesh-toned tattooing done by a cosmetic surgeon with very pleasing results (6).

### Scrotal Graft with Implantation

Before we consider the modern-day implantation procedures, it must be pointed out that the earliest documentation of this technique comes from Dr. H. Feriz who performed foreskin reconstructions in occupied Holland during the Nazi regime (7). Since the doctor refers specifically to helping young circumcised men avoid being "labeled as Jews," it is not clear from his statement whether he helped circumcised Gentiles or Jews escape entrapment. Therefore, I did not include his work in Chapter 7 dealing with foreskin restoration among the Jews. Further, none of the doctors who pioneered the various surgical procedures discussed in Chapter 12 refer to or acknowledge the work of Dr. Feriz. We must conclude, therefore, that his 1962 article, in a German-language publication, which reported his wartime work was unknown both to the doctors and to the men seeking restoration information during the early years of the modern-day movement.

Dr. Feriz's article was written in reply to an earlier (1961) article in which "competent authorities" warned against replacing the foreskin after circumcision, "...since the new skin would be inelastic and

wouldn't serve its [intended] purpose." Dr. Feriz replies: "The experiences I had during the war demonstrate that this need not be the case."

Dr. Feriz's work is as intriguing as his article is brief. He simply describes 1) making a circumferential incision at the base of the penis, 2) pulling the released shaft skin out over the glans and securing it there, 3) pulling the penis through a tunnel he had cut in the scrotum, and 4) suturing the appropriate edges together. After 10-12 days, he then 1) 'mobilized' the penis from the tunnel, 2) sutured the resulting graft edges around the underside of the penis, and 3) closed the wound in the scrotum.

The extent to which Dr. Feriz's wartime work anticipated the later, more advanced techniques described below is fascinating indeed. Equally fascinating are some of Dr. Feriz's 1962 observations. He states:

Following the war, none of my patients requested a newly exposed glans....I myself can warmly recommend it [the procedure] as being harmless and functional....Although the *indicatio vitalis* ['vital to life'] of this cosmetic surgery is hopefully forever relegated to the past, with the growing spread of circumcision in Anglo-Saxon countries, the replacement of the foreskin, if it can be achieved in the described harmless manner, can even today be indicated due to psychological and sexual motives....

More recently, there have been two major contributors to the use of scrotal grafts in this country: Dr. Donald M. Greer and Dr. Willard E. Goodwin. The techniques they developed differ to some extent; however, the procedures share a great deal in common.

Each technique requires multi-stage surgeries, up to four separate operations. Each involves creating a 'tunnel' within the layers of the scrotal tissue and implanting the penis within the tunnel until healing of the grafted tissue has taken place. At that point, the penis is surgically freed and lifted out of the scrotal tissue, and, then, final adjustments or touch ups are done.

**Dr. Donald M. Greer.** Dr. Greer published reports in 1982 on his technique in more than one medical journal (8). And, over the years, the procedure has been slightly modified from time to time. At the time of this writing, Dr. Greer is no longer actively performing foreskin reconstructions. These are Dr. Greer's procedural steps:

1. *Psychiatric Screening.* Dr. Greer has steadfastly required his prospective patients to undergo psychiatric evaluation. While some of his reasoning is understandable, this requirement stands in sharp contrast to the typical demands made on an adult intact male who seeks a doctor in this country to circumcise him.

2. *First Surgical Operation (Figure 20-3 a b c).* An incision is made in the penile covering around the entire penis. The penile covering in front of the incision is freed and drawn forward over the glans. A tunnel is

## Men's Voices...

shaft skin upward creating the new foreskin and then wrap the grafted skin around the middle area of the penis and then stitching it to the remaining shaft skin and to the newly created foreskin. The part of my glans that is covered by my reconstructed foreskin is soft, pink, moist, and yes, I even have smegma!

I've lived like this for all these years until I spoke with several people who attended the Second International Symposia on Circumcision in May 1991. I related my problem of the skin graft color difference. The grafted skin was almost a milk-white color. I also called Marilyn Milos of NOCIRC this past summer for ideas/referrals.

Despite numerous telephone calls, more visitations, and yes, more money, I could not find a doctor who does flesh-tone tattooing. Encountering a series of dead-ends was nothing new for me.

Oddly enough, by chance, I was driving past a cosmetic surgeon's office whose outpatient clinic is less than a five minute drive from where I live when I thought of asking him. I had used him once before for a dermatological problem on my face. I made an appointment with him under the pretense of a follow-up visit for a past problem. When I brought up the subject of flesh-tone tattooing and of my foreskin restoration, I was shocked. He informed me that he most certainly did do that type of tattooing procedure of fleshtones! I scheduled the work to be started for the following week.

He had to do the procedure in two stages. Because of the soreness and swelling of the tender area, he had to do a half at a time. He also had to make sure the skin would tolerate the procedure. Everything worked out fine. It was time consuming—it took well over an hour each time—and it was messy for the doctor because of all the coloring pigmentation, but I feel it was well worth it. This is something I had wanted for a long time. It was costly; his fee was \$1,000. I had to wait at least a week for the second half to be done. A month later I had to go in for minor touch-ups. This was an additional \$200. The total for the

(continued)

## Men's Voices...

complete job was \$1,200. As of late October I am completely healed.

It has taken two decades and an awful lot of money to correct what I feel was a brutal and most certainly unnecessary mutilation. Do I have any regrets? No, I would do it all again if I had to—even spend the money. You would have had to believe in what I do to undergo all that I went through. I only wish that they had simply left me *alone* and *natural* as an infant, sparing me a lot of hurt and pain years later.”

S.C., Atlanta

“I recently completed a surgical foreskin restoration procedure and, prior to undergoing surgery, spent eight months researching the subject. I want to share my story.

Until late in 1983, at the age of 31, I too suffered in silence. My reasons for seeking foreskin restoration were to correct a sexual dysfunction. The lack of sensitivity of the glans of my penis made ejaculations almost impossible. It ruined my sex life and cost me dearly in many other ways personally.

After several humiliating trips to various doctors' offices, only to be thrown out or told I needed psychiatric counseling, I finally obtained the BUFF stretching information.

Over a period of the next 22 months, I utilized the BUFF technique and obtained some rather decent results in stretching. More importantly, recovering the glans returned sensitivity to my penis and sex became a pleasurable thing. Something I had never really known.

While I followed the BUFF technique to the letter, by November 1985 I realized that in order to attain my goal of complete coverage of the glans—whether flaccid or erect—I would have to commit to at least another two years of being taped.

One of the original authors of the BUFF publication had undergone a surgical procedure which had not been successful. His vehemence on the subject of surgery was frightening. Still, I did not want to spend an additional two years' investment

(continued)

formed between layers of the scrotal tissue. The penis is then implanted in the scrotal tunnel so that the tip of the glans is exposed and all raw edges are sutured. This stage is allowed to heal for a period of several weeks or even months. During this healing phase, the penis remains implanted within the scrotal tissue.

3. *Freeing the Penis from the Scrotum (Figure 20-3 d e)*. After the above procedure has healed, the penis is 'lifted' out of the scrotum. This can be done in either one or two separate surgical steps.

4. *Final Touches (Figure 20-3 f)*. When the penis is totally free from the scrotum, the lengthwise incision on the underside of the penis is closed, and any necessary final adjustments are made.

The results of Dr. Greer's technique vary, as would be expected with such an involved procedure. I have seen only one finished example of Dr. Greer's work, and that particular patient is delighted with the results. On the other hand, I have seen pictures of another patient whose results are not pleasing to him. And, in one case, known to me, a patient had himself recircumcised after completing the reconstruction procedure. In all fairness, it must be noted that this individual had been circumcised as an adult and knew firsthand what a natural foreskin should look, feel, and work like. The reconstructed foreskin was simply too disappointing for this particular individual to live with.

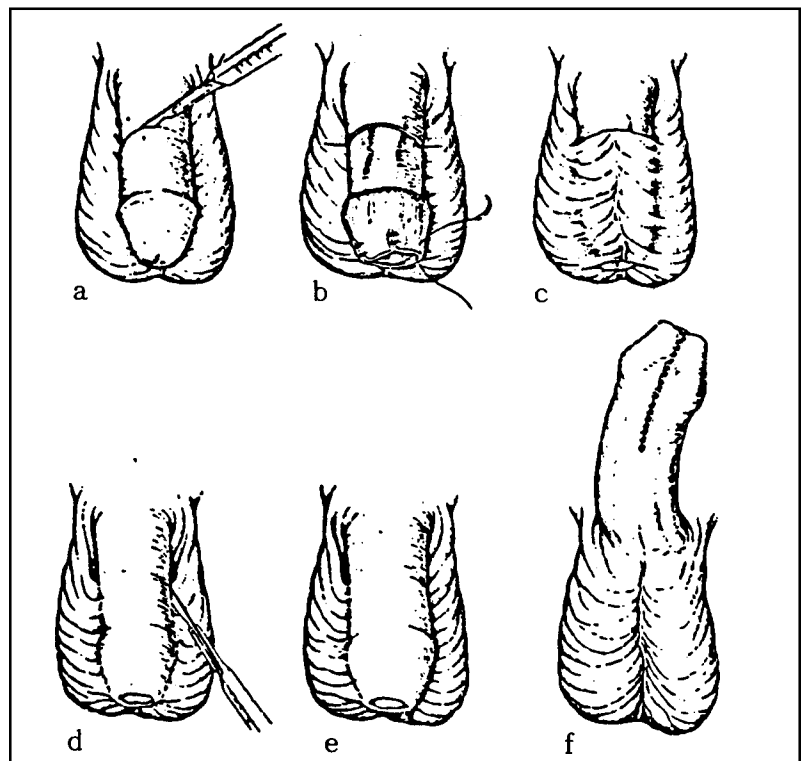

Figure 20-3 Dr. Greer's uncircumcision surgery

One of the most common complications with this procedure is that many patients end up with phimosis which requires additional surgery to correct. Other complications are mismatched skin color and texture, a foreskin that contracts—scrotum style—when the penis gets cold, and sometimes hairs growing out of the new foreskin. For all these drawbacks, Dr. Greer's technique has been one of the most popular modern procedures to date, and those men who are happy with the results are very happy!

**Dr. Willard E. Goodwin.** Although Dr. Goodwin did not publish the article documenting his technique until 1990 (9), he made reference to his work in private correspondence as early as 1982. At the time of this writing, Dr. Goodwin is retired. These are Dr. Goodwin's procedural steps:

*1. Psychiatric Screening.* Dr. Goodwin states in correspondence dated 1982, "...I have always insisted on psychiatric consultation, and have

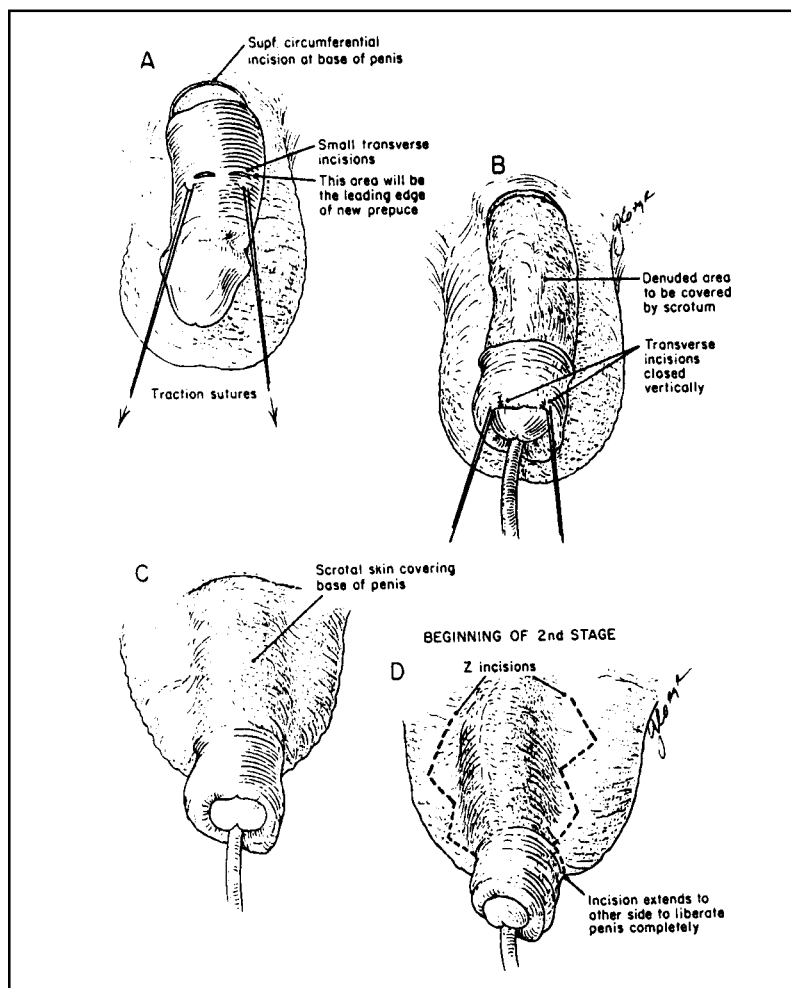

Figure 20-4 Dr. Goodwin's uncircumcision surgery

## Men's Voices...

in stretching. I also discovered that as the skin stretched downward it became thinner, and I was fearful that by the time I achieved complete coverage the skin would be as thin as onion skin paper.

I contacted a source who provide me with a list of five surgeons in the United States who performed surgical procedures.

I soon discovered that their procedures were as diverse in concept as they were in localities. There was only one man listed for California. He personified the image of the Beverly Hills plastic surgeon. Consultation was \$155 before he even met you. His fee was enormous—\$10,000—and hospitalization, medications, etc. were not included in that price. In the midst of my research he died, and his practice was assumed by someone who did not have any interest in foreskin restoration. Scratch one doctor.

The other four doctors were located in Texas, Ohio and Virginia. Fortunately, my job required a good deal of travel, so I was able, over the course of the following eight months, to visit each doctor and discuss their individual procedures. All of the doctors readily provided me with information about their individual procedures, however, when I asked about speaking with some of their former patients, some of the doctors were less willing than others to provide me with any names.

While I understood the former patient's desire for privacy, I explained to the doctors that I was not about to climb onto an operating table without knowing what to expect. Finally, it was arranged for some of the former patients to contact me, and I was given the names of a few former patients with whom I could discuss the surgical procedures.

Beginning in January 1986 I spoke to and visited with the former patients. By May of 1986 I had met or spoken to all but two men who lived in New York. They were patients of Dr. Donald Greer of San Antonio, Texas.

In May I used some vacation time to go to Europe, and upon my return three weeks later, I stopped in New York City to visit with these two

(continued)

## Men's Voices...

gentlemen. What I heard from them and what I saw in the way of final results was amazing to me. It was impossible to tell either of these men had ever been circumcised.

When I returned to California I sat down with all of my notes and reviewed the facts. From the information I had gathered, Dr. Greer of San Antonio had performed three times the number of procedures as any of the other doctors. By May 1986 he had completed 24 procedures. The other doctors had completed only five or six each.

From the results I had seen personally, Dr. Greer's procedure was the most successful. All but one of his former patients were very pleased with the final results. That could not be said for the other former patients with whom I had spoken.

With regard to cost, Dr. Greer's procedure was in the middle of a scale that ran from \$2,000 to \$7,500.

Nearly three years of my life had gone into making this decision and I wanted it to be the correct one.

After reviewing the facts and my extensive notes, I placed a telephone call to San Antonio and requested the surgery from Dr. Greer.

On June 5, 1986 I arrived in San Antonio and was met at the airport by John Strand, a resident of San Antonio and Dr. Greer's very first patient. For the next two weeks John invited me to be his houseguest throughout the surgery and recovery period.

Later I was to discover that John had extended this same courtesy to all of Dr. Greer's patients of whom he was aware, and never asked for any monies in return for all his kindness. Since John had been through the procedure himself and had the benefit of observing some 20 other patients of Dr. Greer's, he knew what to look for in terms of danger signs postoperatively.

Like the other patients of Dr. Greer's, I will always be grateful to John for taking in a complete stranger and providing a very pleasant environment in which to recover.

*(continued)*

turned down more candidates than I have operated on." Here again, it has required more evidence of emotional stability to get a foreskin reconstructed than to have one removed.

*2. First Surgical Operation (Figure 20-4 a b c).* Dr. Goodwin's technique is almost identical to Dr. Greer's, except that the circumferential incision is made at the base of the penis, and the reconstructed foreskin is fashioned from the shaft skin itself. This difference means that, whatever variation in color, texture, or structure the graft may have from the penile skin, these differences are at the base of the penis near the hairline rather than at the tip of the penis as in Dr. Greer's procedure.

*3. Stage Two (Figure 20-4 d).* After approximately three months, the penis is lifted out of the scrotum, and the graft closed on the underside of the penis.

I have seen the results of only one case where Dr. Goodwin's technique was used. The surgery was performed by a doctor outside this country. That particular case resulted in severe complications due to the failure of the blood supply through the original circumcision site. Dr. Goodwin assured me, however, in a discussion with him late in 1991, that he had never had such a complication in his own use of the technique. Further, he states in his article that the procedure is "a simple technique...for plastic reconstruction of the prepuce." He also notes that his procedure closely follows the ancient work of Celsus.

## Rotated-Graft Procedure

Drs. M.J. Lynch and J.P. Pryor of London, England, published a 1993 article entitled, "Uncircumcision: a One-stage Procedure" (10). The procedure follows the initial steps outlined by Dr. Goodwin, such that a circumferential incision is made at the base of the penis (Figure 20-5 a), and the shaft skin is pulled forward over the glans and held there by traction sutures (Figure 20-5 b).

At that point, to cover the denuded area at the base of the penis, an "island" skin flap is cut from the front of the scrotum in such a way that the blood supply is preserved (Figure 20-5 b). The flap is then rotated until it can be wrapped completely around the base of the penis (Figure 20-5 c), and, in that position, all edges are sutured in place (Figure 20-5 d).

I have not seen long-term, follow-up results; however, the article contains a photo taken six weeks after the procedure. The results look very promising. The obvious advantage of the Lynch-Pryor procedure is that it is carried out in a single operation. NORM of the United Kingdom is now operational and is in correspondence with Dr. Pryor and will keep UNCIRC informed of any additional developments. Hopefully, doctors in this country will look into this new, promising procedure.



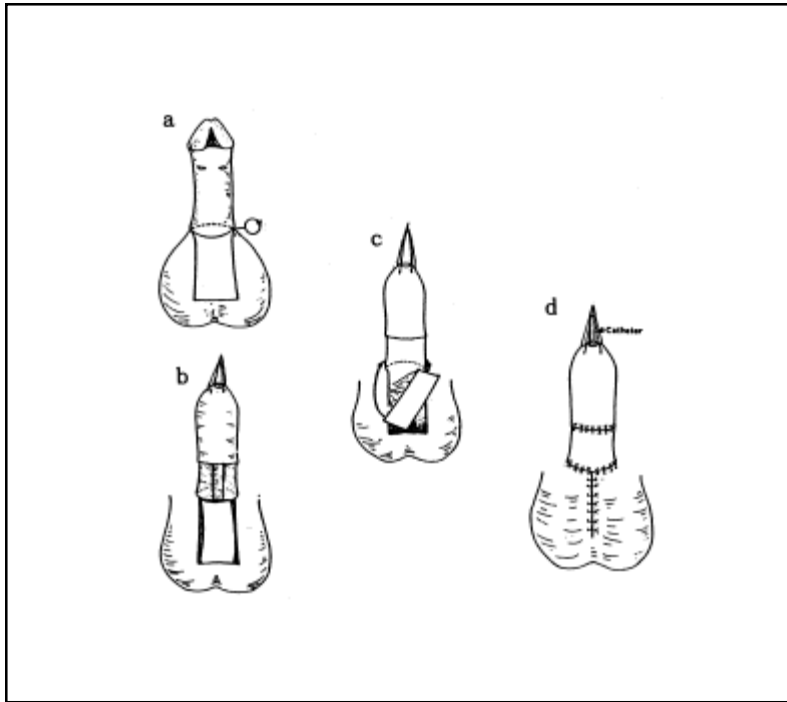

Figure 20-5 Drs. Lynch and Pryor's rotated-graft procedure

### Skin-Expansion Techniques

As discussed in Chapter 13, various procedures for expanding the skin are currently being used for such divergent purposes as treating burn victims and performing breast reconstruction and augmentation. The idea is relatively simple. An inflatable device or 'balloon' is implanted under the skin at the reconstruction site or other designated area and regularly increased in volume to produce additional, or expanded, skin over the device. After the skin has expanded to produce the needed quantity, the device is removed and the extra skin is either 'harvested' for graft purposes or is utilized on site in the particular procedure being performed.

Dr. Goodwin, in his 1990 article, discusses the fact that one of his patients had previously "stretched" his foreskin by the use of traction (the nonsurgical skin-expansion system). He then goes on to say,

Possibly, the same result could be obtained by using one of the inflatable expanding devices that plastic surgeons currently are using to obtain extra skin. This could be a good means to expand the area that is to become the new prepuce. Skin can, indeed, be stretched. Of course, penile and scrotal skin is especially notable for elasticity. All men who experience erections are aware of this elasticity and accommodation to natural pressures (11).

The good news is that Dr. Goodwin's conjecture is already being done.

### Men's Voices...

On Friday, June 6 I had one final meeting with Dr. Greer to discuss the procedure in detail. From Dr. Greer's office I went to my appointment with Dr. Paul Mohl, a staff psychiatrist who works with Dr. Greer screening patients.

Because Dr. Mohl had read my confidential files he was aware that my educational background included a Master's degree in Psychology. Translation of that last sentence: We knew we could not B.S. one another.

I found Dr. Mohl to be very pleasant and easy going. He began by asking me the reasons for wanting the foreskin restoration and what I was hoping to accomplish. I told him of the dysfunction caused by the lack of sensitivity and what it had cost me personally. I told him of my efforts with the BUFF stretching technique and its limited success.

Lastly, I explained that the dysfunction seemed to resolve itself when the glans was recovered, and I wanted permanent results without having to invest an additional two years in stretching.

Dr. Mohl told me he would recommend me for the surgery without any reservations. The surgery was then scheduled for Tuesday, June 10.

I reported to the hospital at 7 A.M. on June 10. Although I was to be Dr. Greer's first case that morning, there was some type of foul-up regarding the operating room schedule and I was asked to sit in the waiting room until my name was called. From then until after 10 A.M. I sat in the waiting room watching the national morning news programs followed by the mindless pabulum of middle America making complete asses of themselves on game shows. Finally, my name was called and I was led to a small cubicle containing a gurney and the inevitable backless hospital gown. I was asked to undress and get on the gurney. Soon thereafter an orderly came to take me to the operating room holding area.

The anesthesia nurse came in and introduced herself and began plugging me into various IV setups. Dr. Greer and his assistant Dr. Davis also stopped in to see if all was going well. Soon I was

*(continued)*

### Men's Voices...

wheeled into the operating room. Once I was on the table the anesthesia nurse asked me to begin counting backwards from ten. I did not make it past six before I was out.

I awakened in my room around 6 P.M. John Strand was there and had already spoken to Dr. Greer, who had reported the surgery had gone well. I was catheterized, and that limited my movement. Honestly, I did not feel like moving around anyway.

Over the course of the next two days I convalesced, taking less medication and feeling better. I was sore but not in great pain. On Thursday morning, June 12, Dr. Greer stopped by to examine me and decided to remove the catheter. I was slightly apprehensive. While I hated the catheter, the apprehension stayed with me until later that morning when I had to get up to urinate. Once I knew my plumbing was working, the apprehension disappeared.

On Friday afternoon, June 13, Dr. Greer released me from the hospital. Everything went well until late Saturday night when I experienced a delayed pain reaction. John brought me back to the hospital where I was told by the emergency room nurse that I would have a long wait. Apparently Saturday nights are when the local rivalries between the military, cowboys, oilmen, etc., explode. She told me that the hospital averaged treatment of a dozen shootings and stabbings each weekend. I thought she was joking.

As it turned out, her estimates were not far from the truth, and when I finally got to see Dr. Davis (who was on duty) he looked drained. The pain medication was changed and I returned to John's house.

Six weeks after the surgery I made a special trip to San Antonio for a checkup, and based on that examination, Dr. Greer decided to perform the second procedure on August 28, following his return from vacation. I returned to California and my job. On August 24 I flew once again to San Antonio and was met by John Strand for the second time that summer.

*(continued)*

**Dr. Charles Horton.** Dr. Horton is currently working with and further developing skin-expansion techniques of surgical foreskin reconstruction. I was able to speak with him during the preparation of this chapter. Unlike the graft techniques described earlier, there is at present no published article outlining Dr. Horton's procedures. Rather, the devices required for implantation under the penile covering are still being developed and refined. Dr. Horton reports that he has done several such procedures but that he only agrees to operate on a small fraction of those men who inquire. The reason he gives for this fact is that most men want near-perfect results, and such results are often unattainable. Obviously, the consequences of a poorly done or extreme circumcision often render the individual an unsuitable candidate for 'like-new' results.

The procedure involves implanting a custom-designed, inflatable device under the penile covering and expanding the skin over time until enough skin has been produced to allow the reconstruction of an acceptable replica of a foreskin. The most pressing need, Dr. Horton notes, is for devices more suitable for use on the penis. The ongoing development of such devices is a priority at the present time.

Dr. Horton estimates that he only works with one individual out of every 25 men who seek his help. I can only hope that, as word spreads and foreskin reconstruction becomes more acceptable, men with less desperate needs and a less damaged penis will also seek help. I suggest that if that happens the ratio of 1 out of 25 will be significantly increased.

### Advantages of Surgical Foreskin Reconstruction

The major advantages are time and convenience. Nonsurgical skin-expansion programs in general require a great deal more time and maintenance to complete. Surgical methods, on the other hand, do not require the participation of the patient to nearly the same degree and are of relatively shorter duration. Furthermore, there are those individual cases where the lack of smooth, hairless shaft skin makes nonsurgical procedures using tape all but impossible.

### Disadvantages of Surgical Reconstruction

We have already considered some of the specific disadvantages of particular procedures, but there are some more general issues which should be considered as well.

**1. Cost.** The cost of surgery is currently very high. Doctor and hospital fees are known to exceed \$15,000 in some cases. These costs do not include such additional expenses as time off work, travel and lodging, and possible required psychological evaluation. The combined financial impact of all of these factors can be staggering. Financial impact is a particular problem for some individuals since many insurance companies do not cover the cost of 'elective surgery.'

**2. Risk of Complications.** As a general rule, the more complicated the procedure, the greater the possibility of complications. Some of the more obvious complications include infections, hematomas, and failure of the graft. Such complications can be mild or severe, and they can be very painful.

**3. Scars.** Surgery always leaves scars which vary with the skill of the surgeon and the presence or absence of complications. Such scars may be barely visible or prominent and unsightly. Since circumcised men already carry a visible scar on their penis, the idea of more scarring can be unpleasant indeed.

**4. Uncertain Results.** As with most surgery, the exact results are uncertain. I have talked with men who are extremely pleased with the result of their surgical reconstruction and others who are disappointed and wish, in hindsight, that they had chosen another means by which to regain their foreskin.

**5. Temporary Sexual Incapacitation.** Some degree of sexual incapacitation during the recovery phases of the various procedures is inevitable. While nonsurgical taping methods can require scheduling, surgical procedures generally require abstinence for days, weeks, or months depending on the particular procedure chosen.

## Most Frequently Asked Questions

While I am not as personally familiar with the questions typically posed to doctors as I am with the questions asked of UNCIRC, two recurrent questions cannot be ignored:

### 1. *Will it work like the real thing?*

Nearly every circumcised male seeking foreskin restoration wants to get back ‘the real thing.’ It can be a tough task indeed to face such an innocent inquiry and have to remind the man that the REAL THING went into the waste basket. The most he, or any of us, by whatever means, can hope to get back is a ‘not too bad’ replica. And, it is understandable that doctors, even the most supportive and compassionate ones, are loathe to promise too much for fear that it is more than they, or their techniques, can deliver. But, if one takes the stance that ‘a half of loaf is better than no bread at all,’ surgical reconstruction may well provide the most functional restoration that some men can hope for.

### 2. *Will it look like the real thing?*

Looks and function, that’s what we all want. Actually, the cosmetic look is often more successful than the function. Again, reality must be considered. Every doctor I know of who has reported on his surgical technique can point to a few cases and declare that the reconstructed foreskin can ‘barely be told from the real thing.’ *Barely* is the operative word here. If you want to be able to pass for ‘never circumcised’ in every situation, including sexual encounters, your

## Men’s Voices...

On Monday morning, August 25, I met with Dr. Greer and was fitted for a clamp that would help divide the pedicle (help separate the tissue). From Monday morning until Wednesday afternoon I remained at the clinic during the day and, between appointments and meetings, Dr. Greer would tighten the clamp gradually. By Wednesday afternoon I was in need of pain medication and, as it turned out, I was admitted to the hospital that afternoon.

The following morning, August 28, I was taken into the OR and the separation procedure was performed. The procedure went smoothly and once again the staff from the 12th floor gave me fantastic treatment, for I had made friends among the nursing staff on my first visit. I remained in the hospital until Saturday, August 30, and was released. On Tuesday, September 2, I returned home to Los Angeles.

The results of my surgery have been very successful, and the best illustration of that was revealed to me in November 1986 at my gymnasium. I had just completed a workout and a shower and was drying off near my locker. A young man nearby kept staring at me. At first I ignored him, but finally I confronted him. I asked at what he was staring. My direct approach apparently embarrassed him, for he turned beet red from head to toe. He apologized and said he had always wondered what it was like to be uncircumcised. He held his own towel away from his body to indicate that he had been circumcised. When he asked me if I had ever considered being circumcised I began laughing. His disbelief was real when I told him what he was seeing was a restoration. He said he was a doctor and diplomatically as possible asked if he could examine me at a later time.

Because I thought this was a perfect opportunity to convert a potential knife-happy doctor, I agreed in hopes that he would prevent some future male baby from being circumcised. I agreed to meet him for a future appointment.

*(continued)*

### Men's Voices...

Following his examination of my surgery he was amazed such a procedure existed. Based on my conversations with him, I think I may have saved some future male child from this brutal, routine amputation of foreskin. I certainly hope so.

Since my surgery those who know of my experience have asked me if I would do it all over again. Without reservations, yes, I would. I am glad I do not have to, but if necessary I would get on another airplane and return to San Antonio and do it all over again.

I realize that this is only restoration. Nothing could ever replace the real thing which was taken from me at a time when I was defenseless to do anything about it. I still harbor some resentment towards my mother, for my father was old-country German, uncircumcised and wanted my brother and I left intact. He lost the battle with the doctor and my mother, for she signed the release because the doctor told her it was 'best' and 'normal' to be circumcised. If it is normal and best, why are men born with foreskin?

The sensitivity has returned to my glans and I am most pleased with the final results.

Obviously, if you can achieve your goals of foreskin restoration without having to resort to surgery, do so. However, you should not be frightened away from the surgical procedures by scare tactics used by those who oppose surgery.

You cannot make an intelligent decision unless you possess all of the facts. Certainly there are risks involved, as with any surgery. But if nonsurgical methods are not accomplishing your goals, surgical procedures are a viable option."

W.P., Los Angeles  
(original manuscript on file  
at NOCIRC headquarters)

chances are not very good. If, on the other hand, you want your glans re-covered and you want to appear intact in most casual situations, your chances are considerably better.

### Realistic Expectations of Surgical Reconstruction

Adopting more realistic expectations is perhaps one way we as circumcised men can truly encourage the medical profession to be more willing to help us. I am not suggesting that we settle for sloppy work. I am suggesting, rather, that we recognize that no amount of money or skill can re-create exactly what we lost. A doctor can bring his best surgical skills to bear upon our condition, but some of the outcome must be left to providence. We can't ask for the medical profession's help and then criticize or denigrate them if unexpected complications or unique features of our particular case deny us the results for which we had hoped. The possibility of such eventualities must be carefully weighed before we enter upon a course of surgical reconstruction. If we do agree to a surgical solution to our problem, we must not set our expectations so high that surgeons will eventually withdraw from helping circumcised males because unrealistic expectations doom the entire enterprise to failure from the start.

### A Look Toward the Future

I have lived long enough to see things being done today that even a few years ago would have been thought impossible. Currently, news releases abound about such things as 'living' tissue cultured and raised in the laboratory, synthetic products like something out of science fiction, genetic restructuring, etc. Sadly, one such 'living' product, Testskin, which is used for testing cosmetics, starts with "skin cells culled from a baby boy's circumcised foreskin" (12).

Likewise, in the summer of 1993, it was disclosed that tests were being conducted at several research centers on a product made from circumcised infant foreskins which is designed to help those "who suffer chronic open wounds caused by diabetes and other circulatory diseases" (13). When interviewed regarding this matter, I responded,

Only this culture deems the male foreskin useless and its loss trivial and unimportant....To rob one man's body to heal another human body—that seems abhorrent to me....At the beginning of life, the foreskin belongs to that infant and no one should harvest it for any purpose (14).

Dr. Duyen Faria, a dermatologist working with the project at Ford Hospital in Detroit responded from her perspective. Among her statements, she refers to severed infant foreskins as "medical waste" and declared to a West Coast reporter covering the story, "The children do not have any rights...the parents determine their rights for them and it's a matter of preference" (15).

After the story containing our interviews appeared in the press, I was contacted by a public relations representative of Advanced Tissue Sciences, La Jolla, California, and asked if I would “listen to their side of the story?” I said that I would, if she, in turn, would listen to mine. After our conversation, with her approval, I sent several pieces of literature, including a copy of this book, which I was assured she would read. There was no response.

In preparation for the current revision of this book, I again contacted the La Jolla center in September, 1994. A new public relations representative assured me that both she and her predecessor were familiar with the material I had sent the previous year. Her main concern was that I should understand that the La Jolla center had collected enough “material” to last for the next hundred years at the present rate of production and that the center had accepted the last foreskin for this project sometime in 1989-90. Mindful of possible future research, I attempted to broaden our conversation to a consideration of the current moral, ethical, and medical debate surrounding infant circumcision. I was told that the center does not involve itself in such issues, which means, of course, that either an unexpected rise in demand for the product in question or a new research project could easily result in a rise in the demand for more “medical waste.” The truth is, anytime moral and ethical issues are set aside, it’s ‘business as usual.’

Often, however, the more imaginative, high-profile research seeks to find ways to better treat victims of traumatic injury or heart attack or those suffering from other more debilitating and even potentially fatal conditions. I would simply like to say to the medical profession, as you are considering uses for your new-found discoveries and innovations, don’t forget us! If you seek to learn ways to produce or enhance new skin growth, circumcised men want to be included in your research considerations. If you develop better and more reliable ways to accomplish skin grafts, circumcised men want to benefit from your advances in technology. Even from a purely financial point of view, we number in the millions, and many of us are unhappy with our present condition. Remember us when you write your proposals and develop your techniques. So far, circumcised men have not been viewed as a potential market, but that day may soon be past. We need help, and we’re looking to you for it.

In the next chapter, we will look at an approach which seeks to tailor a course of treatment to the individual. Such a course of treatment takes advantage of simple forms of nonsurgical skin expansion and minor surgical procedures. This ‘cooperative’ approach between the doctor and the client seems to afford the individual the maximum degree of flexibility and does not require the kind of all-or-nothing commitment to a particular surgical methodology which other approaches by their very nature demand.

## Cooperative Approach: Doctor and Client

*"This approach allows men to regain control of what will happen to their body in conjunction with a member of the medical community."*

**Marilyn Milos, R.N.**  
director, NOCIRC

During most of the last 30 years, an individual who sought foreskin restoration opted either for the grassroots skin-expansion system or for a complete surgical reconstruction of his foreskin. These two approaches to foreskin restoration seemed to demand a kind of allegiance to one method or the other, and men certainly did tend to form camps: surgical and nonsurgical. More recently, a few doctors have begun to recognize the merits of nonsurgical skin-expansion procedures coupled with relatively minor surgical realignments. This 'cooperative' approach, as I am calling it, seems to offer real promise.

### One Success Story

In October, 1991, I received the following information from a gentleman living in a southern state.

For 18 months I did stretching exercises. In January, 1990, I had two Z-plasties on the dorsal side of my penis. One Z-plasty was on each side of my circumcision scar. In August, 1990, I had two Y-flaps at 4 o'clock and 8 o'clock [positions on the penis]. I am now the proud owner of a new foreskin even though it is not quite as long as I would like and it still retracts at what I consider inappropriate times....At the present time, I am still doing some low impact expanding on my own...(1).

This letter recounts an example of a cooperative restoration program: cooperative in that the client periodically carries out a routine of skin-expansion exercises or procedures and the surgeon utilizes his surgical skills at design-

ated points in the program to produce a final result which is the product of their combined efforts. While this approach may not sound revolutionary or like anything new, if one thinks in terms of physiotherapy programs, etc., it is new, or at least the exception, in the field of foreskin restoration.

### One Doctor's Ideas

In the fall of 1991, I interviewed Lynwood, California, urologist, Dr. Michael Scott concerning the idea of cooperative restoration programs. Dr. Scott clarified that the techniques and procedures which he had used up to that time had been performed to repair botched circumcisions or to repair and restore the genitals of accident victims. On the other hand, he expressed a willingness to work with circumcised men who were seeking foreskin restoration. The following are some of the suggested methodologies.

#### 1. 'Stretching' with Testosterone Ointment.

Dr. Scott reported that, in the early stages of reconstruction, he has men apply a testosterone ointment to the penile covering on a regular basis. With each application, the individual is to gently pull or manipulate the penile skin so as to encourage both suppleness and tissue development.

**2. Transverse Incision.** A technique which Dr. Scott uses to reposition the skin on the penis is to make a transverse incision on the underside, at the base of the

penis. This incision is made using the technique developed by Dr. Neil Feins as reported in Chapter 12 (Figure 21-1) (2).

Working through the incision, the penile covering is freed from the connective tissue and moved forward on the penis. Unlike Dr. Feins' description, the incision is then closed in the reverse direction (Figure 21-2). By closing the incision in this manner, the penile covering is further elongated out onto the shaft of the penis.

**3. Contouring.** I discussed the issue of touch-up procedures with Dr. Scott. He noted that he favored the purse-string suture technique as described in Chapter 19, although he was not opposed to using another technique if a particular individual desired it.

Dr. Scott stated that he frequently scheduled the planned surgical procedures several months apart while the individual continued to apply the testosterone ointment and to manipulate or 'stretch' the skin of his penis. The doctor noted that he would favor such a cooperative restoration program in the case of men seeking foreskin restoration on an elective basis and that he would want to tailor such a program on a very individual basis.

### Future Developments

Since my interview with Dr. Scott, I have had occasion to discuss with other doctors the idea of restoration programs which would involve periods of nonsurgical skin expansion and relatively minor surgical interventions. So far, I've met with interest and generally positive responses. I wish I could report here that there is a long list of doctors willing and able to enter into such cooperative restoration programs, but such is not currently the case. The responses I have had so far, however, encourage me to believe that there are doctors who will be open to the idea and willing to consider working with men on an individual basis to map out just such cooperative programs.

In the final chapter, we will consider some directions for the future. As circumcised men seeking help for ourselves, we must lift our voices to help the more than 3,000 newborns being circumcised everyday in this nation. We also must do whatever can be done to empower ourselves and to inform other circumcised men who have not as yet heard that there is help. Where do we go from here?

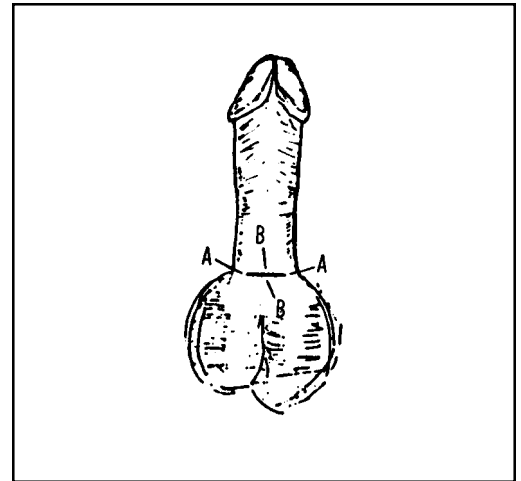

Figure 21-1 Transverse incision

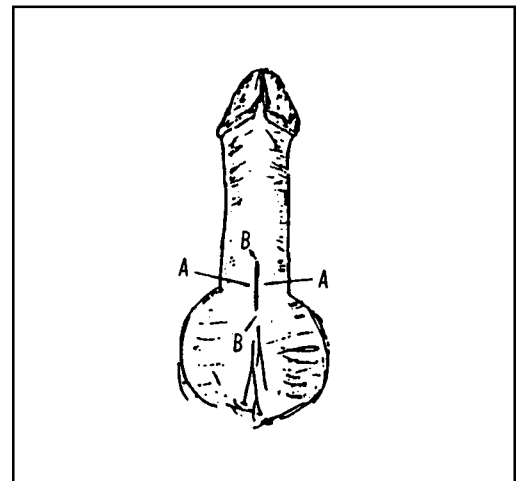

Figure 21-2 Closed incision

## Where Do We Go From Here?

*"Never doubt that a small group of committed citizens can change the world. Indeed, it is the only thing that ever has."*

**Margaret Mead**

### Men's Voices...

"Thank you very much for your information on 'An Alternative Taping Method for Sensitive Skin.' Your articulate work is very important and gives hope to those whose rights were violated by infant circumcision."

S.R., New Jersey

"Please send me the material you have on nonsurgical foreskin restoration. Is there anyone to talk to or write to who you can recommend? I would be glad to give you my phone number and address to give to anyone who would like to talk or share information. I was circumcised at birth much to my disgust and disapproval. So here I am. Thank you for your work and effort."

F.N., Hanford

"From the brief conversation which we had, it sounds as though the procedures which you will describe are non-surgical. If that is indeed the case, I will be even more delighted with undoing something done to me in which I had no chance to express my desires."

C.P., Florida

"Sad to say I was also a victim at birth. Too bad babies cannot fight back, but then that is why they are perfect for something as brutal as circumcision. I have a 7-year-old son who is perfectly normal and happy with a foreskin."

P.N., Maine

In the chapters which outlined the skin-expansion system, we looked often at the healing effects of feeling empowered. We considered the joy of feeling in control and able to do something, especially in a situation where remedy or change had seemed impossible. While it is true that routine infant circumcision continues in our nation on a large scale and that men still have difficulty getting the information, help, and support they need relative to foreskin restoration, the fact is that more public attention is being focused on both of these issues than at any time during this century.

The question, 'Where do we go from here?', immediately highlights challenges both in the fight to stop routine infant circumcision and in the need for more and better resources to help circumcised males regain their foreskin. Actually, the opportunities have never been better to speak out and to make a difference. And an increasing number of circumcised men are indeed finding both their voice and opportunities to take a stand. The array of issues, attitudes, and institutions presented in this chapter which need to be addressed is not intended to overwhelm but rather to suggest arenas in which we as individuals may well find opportunities to use our influence toward change. It's one thing to honestly acknowledge that we have been one of the victims of both circumcision and ridicule for our feelings about it; it's another thing to determine to be part of the force for change.

How and when will we as a nation stop creating the need for foreskin restoration? At the present time over 3,000 newborn boys each day lose their foreskin forever. Several powerful forces within our society must be realigned and utilized if we are to see the era of this very personal damage and loss behind us. What is more, if routine infant circumcision were to stop this year and never be practiced again in this nation, the boys just circumcised will be 40 years of age in the year 2035, and I would be over 100! As a nation, we've sown a vast field of pain and madness. We will be reaping for a very long time to come. One of my colleagues who also works both to stop infant circumcision and to help circumcised men to restore their foreskin



said to me a few years ago, “If we do our work well, we’ll work ourselves out of a job.” And, hopefully, that will be true where infant circumcision is concerned. But I don’t think I can realistically expect to live to see the end of needing to help men already damaged by infant circumcision. The results are simply too long-term.

The three paragraphs above are nearly the same as they appeared in 1992 in the final chapter of the first edition of this book. The issues, attitudes, and institutions which were addressed then are still with us. No sweeping reform or overnight success has transformed either a thorny issue or an entrenched institution into a major victory. On the other hand, some issues and needs have become further clarified and some small, but notable, advances have been made. Therefore, this revised chapter contains most of the original challenges and demands made in 1992 with additions and updates where appropriate. It is, as before, my hope that as you read this last chapter you will see yourself either skilled, situated, or empowered in some area to take a stand and to make a difference.

### **A Plea to the Medical Community**

I know that men and women in the medical profession who are convinced that male circumcision is good for the individual and the human race are not apt to act to stop routine infant circumcision in this country. My concern and plea focuses instead on those doctors, nurses, midwives, etc., who feel that infant circumcision is unnecessary but who do not want to rock the boat or alienate parents and their colleagues by taking a strong position. We set great store in our culture on keeping an open mind and remaining objective. As valuable as these virtues may be, they are often used as excuses for not getting involved and for avoiding conflict.

**Say No to Requests for Infant Circumcision.** Doctors are often heard to say that they personally see no compelling reason for infant circumcision, or even that they believe it to be wrong, however, that they leave the decision up to the parents and follow their wishes.

As we are all aware, we live in a day of tough choices and hard decisions. Whether the issue is the national drug problem, unsafe sex and its consequences, or a host of human rights and environmental concerns, we are more and more encouraged as individuals to take a stand and to do the right thing. Billboards and TV alike plead: “JUST SAY NO!”

Let me state clearly that it is not my contention that doctors are solely responsible for the current practice of infant male circumcision in this country. When doctors state that they are only carrying out the parent’s wishes, I know that their statements may well be true. But it is also true that the medical profession did indeed tout routine infant male circumcision early in this century, and it is also true that the

### **Men’s Voices...**

“I had my son butchered because of peer pressure 15 years ago. How dare doctors perform unnecessary operations just because they felt Billy was going to be too lazy to keep himself clean! I’ve heard a man loses 25% of his feeling because of this. That’s a lot to take away from someone. I told my wife we could take her to a doctor and get 25% of her sexual feeling taken away. Of course she didn’t want such a thing. But neither do I. I’ll never forgive myself for butchering my son, and I intend to apologize to him one day soon. Thanks for letting me get this off my chest to someone who understands.”

D.A., Pennsylvania

“I was circumcised at 7 years old. I begged them not to do it. I screamed until the gas mask was put on me. Restoration is helping me overcome the trauma and humiliation.”

Teacher, Virginia

“I am a 17-year-old male who is circumcised. I got to thinking, what am I missing? Most likely, I’ll never know. It makes me sad because I’m not whole (as I was intended to be). I try not to be bitter about it. I try not to blame my parents, but who can I blame? I had no say in the matter, and after all, it is my penis. It is a part of me that I’ll never know. The society may demand uniform penises, but that pain (although I don’t remember) and disfigurement is not worth it. Circumcision has deprived me of one of my most sensual receptors on my sexual organ. As for circumcision involving a religious rite, it is my belief that any religion that demands physical alteration of the way things ‘should’ be, should be eschewed. What price of sexual freedom have I sacrificed (or rather, my parents have sacrificed for me) for ‘hygiene’ and ‘normality’? Society may demand pain and disfigurement all for the sake of being ‘normal,’ but I demand wholeness for the sake of being natural. If I ever have a son, he will be left whole. If later he chooses to disfigure himself, then that is his choice. What pain and torture for such a needless act! Wake up, America!”

B.J., Oregon

### Men's Voices...

"Could you send me information on support groups and networking for men doing foreskin restoration? Any information would be much appreciated. Also, is there anyone in my area (Birmingham, southeast) who is doing restoration (stretching)? I would really like to meet with them. Thanks."

M.C., Birmingham, Alabama

"Thanks for the information. Please be advised that I would welcome you forwarding my name to anyone interested in stretching for foreskin restoration. I wish to begin a support group here in the Detroit area as I have counselled five or six men on my own on an individual basis.

I would be interested in what type of advertising you do in the Bay Area to make your group known. The Detroit area is not good for establishing men's support groups of any type as the conservative mentality is stifling for any overt public outreach.

I have no problem about participating in a circumcision study other than I am uncut and probably would skew your findings and comments. If you have any other questions, please feel free to contact me."

Physician, Michigan

"I'm writing about your support group. I have been stretching for several years alone, and that's fine, but at some point one needs support. I'm from a small town and I doubt that it would be understood or even heard of. How do you know when you have stretched enough? What's next?

These are the kind of questions I have and I don't know if you share this kind of information, but it must be kept confidential on my part. Is anyone open enough to compare information confidentially or share information on how much is needed before a tuck can be done? I'm alone in this undertaking but this is very important to me.

I own and operate a company that employs 80-100 people. This is why my privacy is so important. Plus, I'm the father of four small children. I would appreciate information which we can share. Thanks for your time."

S.C., Georgia

procedure is carried out by their hands in hospitals and offices where they set policy. Furthermore, in the mid-80s when circumcision rates were at their highest point in this country, 66% of pediatricians and obstetricians polled remained neutral while only 19% discouraged infant circumcision (1). It has often been shown that neutrality *influences* in favor of current trends. The American people did not adopt routine infant circumcision without the considerable influence and help of the medical profession. It is doubtful that we can end the practice without their help!

In CNM Gelbaum's presentation, discussed in Chapter 10, she makes the observation that it is currently the legal right of the parents to consent for circumcision, "and we must honor that request." First, let me say that no medical practitioner "must honor" a request which they personally believe to be wrong! Second, Gelbaum, as a member of the Jewish community, certainly has reason to be grateful to the many doctors in Poland and other European nations who did *not* follow the dictates of the law at a time when the law was wrong! Doctors and other medical professionals who believe in your heart that infant circumcision is unnecessary and entails risks, we need you! We need you to speak up. And, we need you to tell parents, NO!

**Say 'No More' to Painful Research.** At present, routine infant circumcision figures in at least three areas of research. 1) Pain and pain management: The idea seems to be that, since we need to know more about the effects of pain on the infant, an infant undergoing a very painful procedure provides a perfect opportunity to study his cries, heart rate, respiratory irregularities, etc., (see Chapter 4). 2) Less painful ways to perform the actual circumcision: The attitude seems to be, 'since *we are* going to do them, lets make the baby as comfortable as possible.' This attitude has contributed to a spate of research aimed at discovering 'the painless circumcision' (2). 3) Tissue products: To date, cells culled from amputated infant foreskins have been used to develop products designed to provide a "cruelty-free" means to test cosmetics and a skin-like covering for open wounds (see Chapter 20). The researchers involved insist that they are simply utilizing "medical waste." My plea is to stop all such research and instead to protect the baby from unnecessary, elective surgery—with or without anesthesia—to which he is too young to consent. The goal ought to be to preserve the human rights and integrity of the child, not to find a less painful way to violate his body or a 'good use' for either his pain or discarded body part. Please tell your research colleagues, No More!

**Say Yes to Requests for Help from Circumcised Men.** I know of doctors who do not want their name in this book. There are those who do not want any publicity if they offer to help an individual with some aspect of foreskin restoration. They do not want to become

known for work in this particular field of practice. By comparison, I can't think of any legitimate medical service which a doctor would offer to a woman which the doctor would be reluctant to have made public. But the male foreskin, that's a different matter.

Doctors, we need new, improved procedures for foreskin reconstruction. We need innovative techniques to contour our restored foreskins. We need easier access to medical consultation and supportive help. At the very least, we need sympathy and understanding when we finally get up the courage to say that we don't like what was done to us. Across the entire spectrum from initial consultation to final reconstruction, we need the respect afforded to any other human being who seeks medical help for his or her woundedness. The fundamental dictum of the doctor, "First, do no harm," must surely mean at least that you don't laugh the individual out of your office! Any male on earth has the right to wish that his body were whole. Doctors, we need you, and we need you to have a caring and understanding attitude even if you do not feel the same way about your own circumcision. Please, say YES to us!

**Speak Out When You Publish.** Members of the medical community, like those of many other professions, regularly document their work and debate various issues in professional journals, popular periodicals, and books. Unlike many other professions, however, the general public listens for information which may affect their lives to filter down to them. Therefore, when you publish your works, findings, and opinions, take a stand against 'inoculation by amputation' or 'hygiene by amputation,' if such is your view. Like Dr. Kenneth Purvis in his recent book, *THE MALE SEXUAL MACHINE*, tell the public unapologetically why nature has provided the male a penis equipped with a foreskin (3).

**Educate Yourselves and Chart a Wise National Course.** We can learn from other nations such as England, Australia, and Canada. Virtually every country that at one time practiced routine infant male circumcision on a national scale has been left with an unexpected and unnecessary legacy: Their doctors simply do not know how to care for the intact penis throughout the normal stages of development, and, as a result, they over prescribe later-age circumcisions for a host of normal or mild conditions because it's the *one* treatment they know. Sadly, having ended, or significantly reduced, routine circumcision, these nations must now work to end unacceptable rates of later-age circumcisions. At this time, there is a steady flow of articles from within these nations written in an attempt to educate their respective medical communities away from excessive circumcisions to other, more conservative treatment procedures (4). As our nation makes its inevitable move away from routine male circumcision, we can steer a wiser course. Experience may indeed be the best teacher, but it need not be our own!

### Men's Voices...

"The first known support group of its kind in the nation, perhaps in the world, for men desiring to restore their foreskins, was begun in San Francisco in November 1989 by myself and Tim Sally. We met through NOCIRC (National Organization of Circumcision Information Resource Centers) earlier this year.

I had been practicing the BUFF stretching method of foreskin restoration and Tim had started to use this method. Despite periodic encouragement from me, Tim at times felt isolated in his attempts and frustrated at the seemingly limited techniques available to accomplish restoration. Tim suggested the possibility of forming a support group.

We pooled our financial resources and placed classified advertising in two San Francisco Bay Area newspapers. The gay community was targeted first for this outreach since Tim felt that gay men, in general, tended to be more open than their heterosexual counterparts about matters concerning sexuality in general and their genitals in particular. The response was nothing short of overwhelming. Both of us each received over 200 telephone calls within the first few months of the ad being run. No questions are asked about anyone's sexual orientation. From personal conversations with members, it is estimated that at least half of the men are married with families.

The first meeting was held on February 5, 1990 at Tim's apartment with 12 people in attendance. Subsequent monthly meetings were held either at Tim's or my apartment. I send out monthly reminder postcards alerting men of the time and date of the next meeting. Each meeting regularly draws an average of 12 to 17 men, with more (37) in attendance when special speakers were invited.

The group is a peer-facilitated support meeting arriving at decisions through group consensus. No formal dues are paid by members, although participants are encouraged to make generous contributions in order to cover basic expenses such as postage, classified advertising fees, and rental of meeting space. The group soon became

*(continued)*

### Men's Voices...

too large for apartments. A meeting room was rented on a monthly basis.

Almost all the men are in some stage of restoration. We advocate the use of the stretching method to achieve results. It is the least intrusive and gives the best results. The group is aware of all the known surgical techniques and doctors willing to perform various procedures. However, they are usually expensive and the results are not guaranteed. There have been failures. Restoration by stretching is proportional to one's commitment and persistence. The medical journals' reports on 'skin expansion' demonstrate that skin can successfully and permanently be stretched. When you do it yourself, as all of us in the group have done, it is not painful, it works, and it is permanent.

Since its inception, the group has received inquiries from men across North America, demonstrating that this type of support group is indeed timely and necessary. A second group meets in San Jose, California. Many men have expressed an interest in organizing or attending groups in their areas.

At the group meetings, which last about two hours, we open with introductions if anyone new is there, which is usually the case. Then we recap the current events in this field and discuss new things that will be going on. Frequently, we have a guest speaker or some special presentation. Then the last part (usually about an hour) is devoted to group discussion of concerns and how to deal with them. Also, we try to help those who are trying to figure out how to manage the various taping techniques.

Finally men are starting to assert their rights to their own bodies. As a bumper sticker says, 'CIRCUMCISION MUTILATES MEN.' Circumcision must become a choice for men. Perhaps we should have a slogan, 'Men's Choice—Circumcision.' We need to stand up for our rights to our bodies. The women have demanded that right—we men also demand that

(continued)

### A Message to Insurance Companies

Nearly every authority I know of credits the decision by the British National Health Service not to cover routine infant circumcision with influencing that nation away from infant circumcision (5). No sooner did the Health Service refuse to fund the procedure than the nation stopped circumcising her baby boys. And, nearly 50 years later, none of the dire consequences predicted by our nation's pro-circumcision advocates has come to pass. British men simply enjoy their foreskin in good health!

**Money Talks.** The current, often heated debate over a national health care system is reduced again and again to a matter of dollars and cents. In that light, it seems important to take stock of the question of insurance coverage as it relates to routine circumcision. At the present time, several large insurance companies in this country no longer cover infant circumcision, which they have classified as elective surgery. And there are other companies currently considering the matter. "The Oregon Health Plan," frequently held up as a possible model for the proposed national plan, has excluded infant circumcision (6). To help clarify the issue, NOCIRC published a 1994 bulletin for health insurers entitled, AMERICAN HEALTH INSURERS AND CONTRA-INDICATED SURGERY: ROUTINE NEONATAL CIRCUMCISION (see listing under RESOURCES). It seems certain that private insurance companies will play a major role in whatever national health care system evolves. I would like to make the same plea to these companies as to the medical profession: arm yourselves with the facts, and JUST SAY NO!

**Say Yes to Circumcised Men Who Need to Feel Whole.** There is an ongoing debate between insurance companies and several fields of medicine as to the degree to which various reconstructive or 'cosmetic' surgeries are truly *elective* procedures and the degree to which they are *necessary* for the individual's well being. And I don't flatter myself to imagine that these few words will settle any such debate. It just seems morally right to say to the insurance companies who were active participants in multiple millions of infant circumcisions that you ought at least to consider your moral obligation to help to reverse the original damage for which you paid. To the many men who can't afford current medical fees for restoration procedures, insurance companies, JUST SAY YES!

### The Need for New Cultural Attitudes Toward Males

I have already recited at various points throughout the book the old nursery rhyme: What are little boys made of, made of? Snips and snails and puppy dog tails. And, of course, little girls are made of sugar

and spice and everything nice. Even such an apparently harmless old saw generates some very interesting behaviors.

**Recent Research.** In a series of studies, researchers found that little boys and little girls are reacted to and treated differently from the very beginning of life. When parents of newborns rated them, they rated their daughters as smaller, softer, and more finely featured than their newborn sons, even though the infants did not differ in these ways. Fathers also perceived their daughters as less strong (7). Moreover, when parents interacted with their preschool children in teaching situations, they demanded independence from their sons and were more likely to respond quickly to their daughters' requests for aid (8). Further, teachers too have conventional expectations toward the sexes: They anticipate that boys will be more unruly and have more learning problems than girls (9). And research has clearly shown how often *behavior follows expectations!* Unfortunately, these differing attitudes toward the sexes do not disappear as the individual moves from childhood to adulthood.

**Differing Cultural Attitudes Based on Sex Roles.** Notice, if you will, one of the most obvious male-female role differences: the slap in the face. A woman in our culture is still allowed to slap the face of a man who has been rude to her or in some way insulted or annoyed her. One only needs to count the slaps in films or on TV to realize that a real double standard exists. No behavior of a woman is seen as appropriate justification for *him* to slap *her* in the face—that is abuse! This double standard is particularly incongruent in terms of our current concerns about domestic violence.

There is increasing awareness that domestic violence is at epidemic proportions. And, we know that women and children are most frequently its victims. We are rarely told, however, that men too are victims of domestic violence and that abused children are frequently abused by a woman. My point is this, any physical violence by one human upon another is not okay! There are no insults which deserve a 'good slap in the face'—by either gender! If we are going to stop domestic violence, we must not condone behavior for one gender while condemning it for the other. The very idea that he, as a male, should be able to 'take it like a man' allows us to react to males across the board in a far more calloused way whether we are the policeman called to deal with a domestic dispute, or a father expecting more trouble from his son than from his daughter, or the nurse strapping the little fellow to the circumcision board so he can't squirm too much.

In 1992, when I first wrote the paragraph above, there seemed little hope for an 'official' recognition of female violence upon men; however, a new California law does just that. The 1994 state law requires "...first time violent offenders to go through a comprehensive gender-specific program as part of their probation." Furthermore, the

## Men's Voices...

right. When men finally realize what they really have lost, they will storm the hospitals and stop all infant circumcision."

R. Wayne Griffiths, California

"I really did get a sense of support from you and the other members of the group last Sunday, although I felt a little uncomfortable at first; I guess that was to be expected. The whole concept as reality is new to me, and it's hard to realize that others have had some of the same feelings about being circumcised that I have had. Some of my thoughts were well-developed, and some are just coming together now.

Men usually have a tough time getting in touch with and expressing their feelings about lots of issues, especially very sensitive sexual ones. I certainly did feel that the group was well along in the areas of understanding and acceptance. I am not homophobic, but neither would I feel completely comfortable in an all-gay group, so I'm glad to learn that this is a male issue and group, not just a gay issue. I understand and accept how your group is formed, and I expect to continue to feel comfortable, accepting, and accepted in it.

I also came away from the meeting feeling very good about three other things I learned: (1) The stretching method works. (2) The stretching results in generation of new skin, not just stretching and thinning what you start out with. (3) Increased sensitivity and sexual pleasure does happen. Sex is great for me now, but I look forward to even better times and to gaining a sense of wholeness and rightness for my body. I'm very comfortable with my body now, and I've already gained a sense of peace just knowing that physical and emotional healing can happen. Stretching is having some effect, I think, and I feel comfortable with the understanding that this is a long process, and I expect to continue.

Thankfully, my wife is a very supportive and sensitive woman, and our discussions about this issue have allowed her to share some important feelings that she has about other sexual and

(continued)

### Men's Voices...

childhood things; we are growing as individuals, and our marriage is growing as well. Good communication has fostered more good communication.

A month or so ago *Life* magazine had a special issue on life rituals from a forthcoming photographic book on the subject. I encourage you to get the magazine. There is a terribly haunting photo of the face of a girl being circumcised in Egypt and of a boy after circumcision in Turkey, I believe. The looks on those two children's faces speak volumes, and I am getting in touch with some of those feelings myself.

I am grateful for the ease with which members could show their progress to those of us new to the wholeness process. Seeing that it works did wonders for my sense of well-being."

H.J., Stockton, CA

### Women's Voices...

"I recently read an article by Jim Bigelow on 'Uncircumcising' in your Summer 1994 issue of *Mothering*, and I would like to provide some personal insight.

Before my son was born I had determined through personal research that there was no need for circumcision. I did not know that 'my' decision had allowed my husband to avoid an intensely painful topic. The birth of a friend's child years later led him to work through much of his own personal trauma. During this time he acquired Jim Bigelow's book and completed an uncircumcising procedure he had attempted years before.

I was pleased, but not surprised, to see changes as my husband's self-esteem and confidence rose. We both appreciate the control and staying power his more abundant foreskin gives him. What I was totally unprepared for was the physical difference I experienced. I began to notice that I no longer experienced any soreness, even with prolonged intercourse. This was something I had

(continued)

Monterey County Probation Department reports: "Of the 329 people currently in its domestic diversion program for misdemeanor offenders, about 100 are women who have battered their spouses" (10). The program's administrator notes: "This is just coming out of the closet...it's not real macho to have your wife beat up on you."

**Violence Toward Males as Entertainment.** Whether the entertainment is prize fighting, contact sports, or Rambo, we seem to get a kick out of violence. And the objects of the vast majority of physical, brutal assault are male. To be sure, there are films which depict terrible brutality on women, but these films are rarely seen as fun entertainment. A woman being blown away just doesn't get the same reaction as when that same violence is carried out on men. Rambo would not be a folk hero if he were always mowing down the bad *gals*—even if they were a combination of Ma Barker, Lizzie Borden, and the Amazon women. But violence upon men, that's a different matter. Not only will such violence be accepted by an audience, it can get some real laughs. Just let the guy get kicked in the groin and listen to the audience howl—first in vicarious pain and then in raucous laughter. And, more recently, some well-received films have had the kick in the groin administered by the female heroine, whereupon even men in the audience can be heard to shout, "Right on, give it to him!" Again, no role reversal would be tolerated here. It would not be *funny* if a man kicked a woman full force in her groin—even in the absence of the same anatomical targets!

**Violence Toward Males and Infant Circumcision.** Our differing cultural attitudes toward males and females as appropriate objects of violence impact directly on the attempt to deal with infant male circumcision in this country. Surgical alteration without an anesthetic is just no big deal when its done to an infant *male*! Again, there is no possibility of role reversal here. Even though serious medical articles have been written to describe both the procedures and the benefits of female circumcision, there is no way we would let doctors cut and alter the genitals of our little girls! But boys, that's different. Recently, an anti-infant-circumcision activist was explaining the infant male circumcision procedure to an active feminist. After hearing the procedure described, the feminist replied, "Well, if a man can't take that, what can he take?" (11). Human rights activists, we need you to defend the rights of all human beings—female and male from infancy to old age!

**Foreskin Restoration: No Laughing Matter.** Sex-role stereotypes make it very hard on the male who wants to regain his foreskin. A male in our culture who is *too* aware of his grooming, his appearance, and his body will be accused at least of narcissistic tendencies and probably of being homosexual. That's because we don't expect *real* men either to care about their bodies too much or

to ‘cry over spilt milk.’ To be sure, body builders and other athletes can work hard on their bodies and even pamper themselves a bit, but it must be done in a *masculine mode*. It is very easy for a male in our culture to get himself laughed at or made fun of for behavior unbecoming a male—such ridicule can just as easily come from a female or another male.

As a psychologist, I have worked with the results of these cultural attitudes at very painful levels: men with huge amounts of anger stored up because it was never appropriate to cry or be weak. Little boys who had to be tough enough to earn dad’s approval do not find it easy to get in touch with the hurt feelings they have denied most of their life. We must make it truly okay for big boys to cry. If circumcised males in our culture are ever going to share honestly their feelings, we as a culture will need to provide an atmosphere in which hurt, pain, and anger from being subjected to a grave indignity can be voiced without fear of further humiliation.

**Circumcision: Whose Penis Is It?** Before leaving the subject of differing expectations, one more issue needs to be addressed. Every time the subject of male circumcision is discussed on radio or TV talk shows at least one woman in the audience or over the phone comes forward to say that she prefers intercourse with a circumcised male. Sometimes the stated preference is on the basis of perceived cleanliness, but often it has to do with *her* preference in terms *her* sexual attraction or stimulation. Either way, it is expected that men should be glad or willing to be circumcised if their female partner prefers it. On one TV show, a woman in the audience related that her mother had refused to marry a suitor until he had himself circumcised to please her.

When I hear this sort of attitude expressed by women, I often wonder if they realize that their attitude and reasoning is the exact mirror image of those held by men in parts of Africa and Egypt who will not marry an uncircumcised woman. As a matter of fact, a father in those traditions could hardly give an uncircumcised daughter away much less collect a suitable dowry if the girl has not been properly trimmed and made fit for marriage. If one uses the reasoning that an individual should be glad, or at least willing, to be circumcised in order to please others, then young girls in these cultures should certainly not mind; after all, they are bound to make at least two men—a husband *and* a father—happy!

It seems important to note here that even the ‘official’ stance is often quite different toward genital mutilation carried out on males and on females. While the effort to end female genital mutilation (FGM) has become the official agenda in many parts of Africa, the SOUTH AFRICAN MEDICAL JOURNAL published an article in 1990 which outlined a program to educate the circumcisers of males

## Women’s Voices...

lived with all of my adult life, although I used lubricants and frequently reached climax. In addition, the movement of the foreskin is intensely more stimulating. We are delighted both for ourselves and for what we have done for our son.”

Letter to the Editor,  
*Mothering*, July, 1994, by  
Kathryn A. Hampton, California

“There are those who say that a man who was circumcised as an infant cannot miss what he has never known. I can think of many cases where people who have been born without something, for instance, sight, hearing, normal limbs, etc., definitely DO miss what they have never known. In my own case, although I have adopted five beautiful children, I have never had a baby. I have never known exactly what it is like to carry a baby inside me, feel it kick, or push it out into the world, but I DO know, very well, that I am missing something.

Men like Jim Bigelow and Tim Hammond, those who have contributed to the harm documentation study, and other circumcised men who are working to educate Americans and put an end to this practice are to be admired. They regularly face criticism, ridicule, and questions about their sanity. It would be much easier for each of them to keep quiet and look the other way, as has been done by most Americans for decades. They have actually taken the ‘personal-responsibility philosophy that usually characterizes the natural birth and parenting movement’ one step further, by taking responsibility not only for themselves, but for others, including those who are yet unborn.”

Letter to the Editor,  
*Mothering*, July, 1994, by  
Darilyn Starr, Mantua, UT

“I just finished reading your article on ‘Uncircumcising’ in the Summer 1994 issue of *Mothering*. Thank you so much for your frankness and courage! It’s so good to know men are reclaiming their bodies in this time when women are, too. Here’s to the day when reclaiming won’t be an issue any longer!”

R.L., Oregon

### Women's Voices...

"Speaking as a young lady who relies on the ripples of her partners' foreskin during intercourse for her climaxes, I was heartened to read of your 'foreskin restoration' program to help those unfortunate enough to have been robbed of this most exquisite and essential part of their anatomy.

The media constantly harps on about the horrors of female circumcision and how it has no place in the civilized world, but to me it is no more evil in principle than what is done to males without a second thought."

J.S., England

### One Defensive Woman...

"Are you crazy and out of your minds? Why would you even consider restoring yourselves? Don't you know how unattractive you would be making yourselves? I find an uncircumcised penis to be an ugly, stupid-looking appendage—a total turn-off. It has always been a disappointment for me the few times I have encountered such an unfortunate man. Seems that extra skin makes for encumbered sexual experiences, aside from the fact that I will not perform fellatio on a cheesy, bad-smelling organ. You should be grateful for your circumcisions! A circumcised penis feels so much nicer to a woman also. If you men care at all about pleasing the woman (or women) in your lives, please reconsider. This is not part of the backlash against feminism is it? Don't cut off your noses to spite your faces, boys. You'll be big losers—just leave well enough alone. But then if you got to change something, why not restore the 'outies' on all those 'inies' and re-enhance all those inadequate belly buttons you may have. Contemplate that, gentlemen."

B.L., Cleveland

among the Xhosa, since "it is a matter of tradition, pride and honour for every Xhosa man to have a traditional circumcision." The article, written by a doctor working in a regional clinic, documents septic wounds, fever, and severe pain and describes necessary treatments such as sloughectomy, skin grafts, and intravenous antibiotics (12). The question arises: why not attempt to end such a practice among males, even in the face of strong tradition, if we are willing to 'interfere' with 'tradition, pride, and honour' in the case of females? It would seem that differing attitudes toward males and females is the only obvious explanation.

Isn't it time that we, as human beings, look beyond our own narrow backgrounds, attitudes, beliefs, and even preferences? Isn't it time that we affirm the right of every human being to the body that nature designed? By what right do we demand otherwise? The human body, male or female, was not intended to be carved to suit the sexual appetite of the individual's partner. Women, you have done so much to claim your own rights; we need you to contend for the rights of men to the ownership of a whole body too!

### A Demand for the Human Rights of Infant Males

The whole world is becoming increasingly aware of the basic human rights of the individual. Cruel and unusual punishment is universally condemned. Nations can lose status, stature, and economic inclusion if various political practices which violate individual liberties are sanctioned by their governments. Since the 60s we have been experiencing in our nation a truly spiritual awakening to civil rights. While this awakening is not moving forward at an even pace, as an individual born in the 1930s, I am very aware that, "The times they are a-changin'." Two of the major areas of change in the past several years have involved the rights of minorities and the women's movement.

**Women's Rights.** We have seen a mighty force unleashed in recent years as women have found, and are continuing to find, their voice and their power. Even if one looks back as far as the Suffragettes and the right to vote, women united for their rights is a relatively new phenomenon. When viewed from such an historical vantage point, the rate and power of their impact on modern-day thought and law is phenomenal.

**Freedom of Choice vs. Right to Life.** It is inevitable that I will disappoint nearly every reader by not declaring my stance on this most potent issue of our time. My point, however, in citing this controversy is not to declare for a particular side but to point out that each side justifies its stance on the grounds of human rights: one side favoring the rights of the woman and the other side favoring the rights of the unborn child in an instance where these two human rights would seem to conflict. What an incredibly thorny issue. My point, however, is a



relatively simple one: both sides represent a fervent passion for a fundamental human right. And, however heated the debate, fundamentally it has to be good for a nation to generate such thought, attention, and action relative to basic human rights.

**Men Have Rights Too!** Some women acquaintances of mine are quick to point out that men always have had special rights. I would simply like to note here that, whatever ‘privileges’ men in this culture have had, they came with strings attached and at an enormous cost. One particular result is that men continue to die 8-10 years earlier than their female counterparts. The ‘right’ to compete contains the implicit expectation and demand that one do so and that one succeed at it. The number of suicides each year by males who no longer feel ‘useful’ is astonishingly high. Warren Farrell, Ph.D., has dealt with these and other related issues with great aplomb in his 1993 book, *THE MYTH OF MALE POWER* (13).

Clearly, certain indices can be cited by the women’s movement which verify that men historically have gotten to play for much higher stakes than have females. My point is simply that the price to the male for the privilege of playing and staying in the game traditionally has been pretty high! And, in spite of all you’ve heard to the contrary, big boys do indeed cry, usually alone.

**Infant Male Circumcision as a Human Rights Issue.** While I make a strong plea in the next section of this chapter for valid research to be done relative to the effects of infant circumcision, the fact is that such research ought to be quite beside the point. Newborn infants just arriving in this world should not be in peril as to the safety of their genitals! And this same simple protection ought to extend throughout childhood as well. Until the individual is an adult, legally empowered to make surgical decisions for him- or herself, all children ought to be able to expect that no harm will come to them from the adults in their world. It ought to be an outrage to amputate a healthy, living part of a child’s body so that his parents won’t have to learn to care for it, or so that the child will match a family style, or in order to be considered property fit to meet some social, cultural, or religious model. The genitals of a child are not communal property. They do not belong to the parents, the family, or the larger community. They are the private property of the individual and ought to be protected as such—by law!

In America, virtually every other part of the human body is protected—male or female. Parents cannot take a baby or child to a doctor and have any other healthy body part removed for convenience or tradition. Most doctors today will no longer arbitrarily perform even the once-popular routine removal of tonsils, adenoids, mastoids, etc. And *arbitrary* is the key word here. After a three-column article intended to help parents make the ‘circumcision decision,’ Cecil Adams, with complete disregard for the rights of the child, concludes:

Bottom line? He’ll survive either way. Flip a coin (14).

In practical fact, except for the foreskin, only diseased, injured, or malfunctioning body parts are subject to treatment or removal. And, today, doctors and parents alike often seek a second opinion before taking more extreme measures. Why is there no such protection in this country for the male child’s foreskin? Human rights activists, we need you!

Finally, I’m pleased to report that in 1992 the *JOURNAL OF NURSE-MIDWIFERY* accepted and published an article by Marilyn Fayre Milos, R.N., and Donna Macris, CNM, MSN, which challenges the notion that routine infant circumcision is rightfully a medical issue. The article, “Circumcision: A Medical or a Human Rights Issue?,” addresses the prevalent medical issues but concludes that such issues are in fact immaterial relative to the right of the individual to the integrity of his own body (15). Strangely, when the same journal, the next year, published a review of the first edition of this book, the reviewer, Laura R. Taylor, CNM, MSN, noted:

Some issues used to debate circumcision are human/civil rights and men/women’s rights. These themes are repeated throughout the book and *it seems unnecessary*. Dr. Bigelow compares circumcision to human/civil rights violations and child abuse. This reviewer *questions these comparisons as extreme* (16). (Emphasis JB)

## **A Plea for Valid, Cross-Cultural Research**

At this point in human history, the impact of research cannot be ignored. The entire Western World increasingly relies on research findings to help make its decisions and establish its policies. Ultimately, these decisions and policies come to shape our attitudes and beliefs.

**Shortcomings of Research in the Fields of Human Behavior and Medical Science.** It is a well-established

fact that most research, certainly most published research, finds the answers for which the researcher is looking. As soon as such research is published, the critics take over. Very often, there follows a long process of claims and counterclaims. In the best-case scenario, this process leads ultimately to new, supported information about and fresh insight into the subject. In the meantime, in the words of the old theatrical pronouncement, 'time passes.' The research literature is filled with such see-saw debates over crucial issues which, in some cases, have lasted for years.

In the case of infant circumcision, vested interests run high. The likelihood is that the research-debate phase of this argument is going to have a long run indeed! In the meantime, not only is time passing but the mutilation goes on, and the vested interests become more and more entrenched. As one who has focused on informing and supporting circumcised men as they seek to restore their foreskin, tragically, I can look ahead to see that there will be ample grist for the mill for a long as I will live.

**Strengths of Well-Done, Valid Research.** For all of the shortcomings, relative to the cumbersome nature of research, valid findings are eventually very powerful tools. And I would make a strong plea for well-planned and -executed research programs. Let's look carefully at the possible long-term psychological effects of infant circumcision. Let's do cross-cultural body-image research with males instead of assuming that the male of the species simply isn't effected one way or the other by foreskin amputation. Let's expand work like Dr. John Taylor's, discussed in Chapter 2, so that we know more about the structure and function of the foreskin itself. Dr. Taylor's work already informs us that the foreskin is a very complex structure richly supplied with blood vessels and nerve endings. Let's find out more about it. It is clearly not scrap tissue!

Given the current status of research evidence, it seems unlikely that permanent advances can be made to stop routine infant circumcision until valid research substantiates the value of the foreskin, the immediate and long-term effects of infant circumcision on the individual, and the loss of penile responsiveness and sensitivity due to circumcision. Researchers, we need you!

When I first made that call to researchers in 1992, I had no idea that by 1994 we would have available some

very valuable survey material from which researchers might build more sophisticated proposals. Not only do we have the JOURNEYMEN survey reported in Chapter 5, but we now have the results of the NOHARMM survey (reported in 1994) which gave 313 circumcised men an opportunity to document their own perception of the harm they feel circumcision has done to them. Admittedly, this information is anecdotal, subjective, and from a self-selected subject population, but such limitations relative to *preliminary* research projects are usually only faulted by those who are opposed to the research in advance.

For example, Dr. Edgar Schoen of the American Academy of Pediatrics Task Force Committee on Circumcision writes and speaks out frequently to say that every harm claimed by anti-circumcision groups is anecdotal in nature and, therefore, invalid (17). I, just as frequently, find myself wondering if Dr. Schoen would be so quick to tell members of a rape victims' support group that they have *no evidence* that they have been harmed by their rape, unless some measurable, quantifiable consequence can be documented by "scientific instrumentation"? The fact is that self-report research is viewed as both valid and credible over a vast range of inquiry, including the field of medicine. To ignore the reports of thousands of men because their perception of their own circumcision wounds and pain are judged invalid out of hand reflects far more upon the judge than upon the judged. There is probably no other group of victims in this nation whose plight would be dismissed in such a cavalier manner. Vested interests build powerful blinders.

With all the recognized shortcomings of a typical preliminary poll, the NOHARMM survey provides some interesting insights and offers future researchers some very fruitful areas of inquiry (18). The following is a sampling of the findings:

	<u>Percent</u>
Suspected/confirmed reduction	
in sexual pleasure due to circumcision	96.2
Feel harmed by circumcision	92.7
<u>Particular Areas of Harm Reported:</u>	
Feel mutilated	62.0
Do not feel whole	60.7
Do not feel natural or normal	60.1
Human rights violated	60.1
Glans insensitivity	55.3
Feel inferior to intact men	49.5

Excessive stimulation needed to orgasm	38.0
Feel betrayed by parents	33.9

Finally, those interested in conducting research projects relative to the possible effects of male circumcision, particularly long-term psychological and social effects, will benefit from reading *THE PSYCHOLOGY OF CIRCUMCISION* written and published in 1994 by Ronald F. Goldman. This 189-page document reports the results of various preliminary surveys and poses a range of research questions, as well as suggesting a variety of theoretical frameworks from which to study such questions (see listing under RESOURCES).

### **A Challenge to Cherished Beliefs and Traditions**

Whether I address Jews, Christians, or Moslems in this nation, I risk offending them if I challenge the validity of male circumcision. But it is a risk I have to take. If I am to be true to the hundreds of wounded men from all religious backgrounds who seek help, I must take that risk.

Everyone of us who is a committed follower of a religious tradition can look back in our respective histories and note moments of radical change or redirection. We all have writings from other eras which we now have the courage, or simply the historic distance, to smile about as relics of a bygone age. We sometimes forget that those who were alive at the moment of those changes agonized and often fretted that some irreversible loss would be sustained if certain ‘standards’ or observances were set aside. The passing of the Latin Mass and fish on Fridays are still mourned by some of my Catholic friends.

It is certainly tough business to re-evaluate objectively and honestly any aspect of a ‘faith once delivered to us by our fathers.’ But we are today at such a juncture. Throughout the world, we must stop mutilating our children in the name of God and faith. To that end, Sami A. Aldeeb, Doctor of Law, of the Swiss Institute of Comparative Law, presented a paper entitled, “To Mutilate in the Name of Jehovah or Allah,” in 1994, at the Third International Symposium on Circumcision (19). And, at the same symposium, Anastasios Zavales, Ph.D., Founder and Secretary-General of Ecumenics International, Inc., presented a paper outlining an interdisciplinary approach to applying accepted universal human rights criteria to the full spectrum of genital mutilation (20). By whatever means possible, we must find ways to retain the *spirit* of that

which the rituals sought to declare and depict while respecting the rights of the individual to his or her own body. What a challenge! But, it is not an impossible challenge. Ministers, rabbis, priests, theologians, Bible teachers, we need you! And we need you to be courageous!

### **A Call for Political and Legal Action**

I find myself envying the British. Within a few short years, they studied, reported, and repudiated the whole issue of infant male circumcision. The British circumcision rate is estimated to have been 85% of the upper class and 50% of the working class at the start of World War II (21). Then, in 1949, Dr. Gairdner published his now famous article, “The Fate of the Foreskin” (22). This article is credited with prompting the decision of the British National Health Service not to cover infant circumcision. By the early 70s, the British circumcision rate was less than 1/2 of 1% (23). I don’t think I’d be so impatient with the situation in this country if it weren’t for the fact that circumcision produces irreversible anatomical results and individual victims! As I work day after day on this book, I am aware that all over this nation little fellows are being strapped down, terrorized, and permanently altered for life—even as I write. I would be less than honest if I did not admit that at times, as I am writing, I weep for those babies.

Basically, I am an educator. I wish that publishing facts and scholarly opinion would bring an end to the brutality and nonsense of infant circumcision in our nation. But that doesn’t seem to be happening. Recently, an acquaintance of mine, who is a Reform Jew, said to me, “Don’t lobby for laws; give us a chance to bring about changes from within the tradition. Some of us are working on it.” I could hear the anguish in the voice and see the pleading in the eyes. After all, I too have been a crusader within my own religious tradition from time to time, so I recognized the feelings and the struggle.

I admit that I am torn as to what is the best course of action. I find myself wondering, for instance, if well-meaning and good-hearted white teachers in the South, working from within the system, could have brought about integration in our schools if only we had given them just a little more time. Or, was it really necessary for the President of the United States to send in the National Guard and demand and enforce legal compliance to civil rights legislation? Perhaps only history will reveal the

answer to that question. One thing is certain, however, there are today thousands of African Americans with degrees from some of the most prestigious schools in the land who might well be too old today to accrue any benefit if we were still waiting for goodwill and 'educating the public' to effect change. With this example in mind, I somewhat reluctantly declare, lawyers, politicians, and voters stand by, I think we may well need you!

After the first edition of this book appeared, a colleague alerted me to a rather extensive article by William E. Brigman, published in the JOURNAL OF FAMILY LAW, 1984-85. The article is entitled, "Circumcision as Child Abuse: The Legal and Constitutional Issues" (24). Dr. Brigman concludes that, in his opinion, the wisest course of action would be a civil rights class action against hospitals designed to prevent circumcisions except in cases where the procedure is deemed medically warranted. Other legal avenues may soon be open as well. The currently proposed legislation to outlaw female genital alteration in this country may well offer real possibilities for future action. Clearly, both the courts and legislation may well provide viable arenas in which to fight to protect the rights and the body of infant males.

### **A Proposed National Registry**

In 1992, I proposed the establishment of a national registry that would register doctors willing to work with males seeking information, support, and treatment procedures relative to foreskin restoration. Since that time, however, it has become increasingly clear that a far more comprehensive registry is needed. In addition to restoration needs for circumcised males, NOCIRC, UNCIRC, and other information centers hear from parents of intact sons and from intact men themselves requesting help to find doctors who will treat or advise an intact male without undue recourse to circumcision. It seems apparent that we need a full range of medical professionals who will treat males who wish to either regain or retain their foreskin with the dignity and understanding that such a male deserves.

It is also abundantly clear that many doctors who favor leaving the penis intact are reluctant to publicize their stance for fear of incurring debate or disfavor from their medical associates and/or institutions. Despite this widespread reluctance, there are at present tentative plans to solicit cooperation from a full range of health care providers pursuant to a national registry. Once again I

plead with doctors: We need you to be willing to be known, available, and listed.

### **The Need for Improved Networking Among Interested Men**

At UNCIRC and NORM, as well as other information centers, we have always assured privacy and anonymity to those who make inquiries, and this option must always be available to those who choose to remain anonymous. On the other hand, we at UNCIRC and NORM hear regularly from men who would like to correspond with others who feel as they do about being circumcised and who are working to restore their foreskin. Because of this desire for support from other men, I proposed in the first edition that a national network be established to help interested men contact each other. I'm happy to report that the proposed support network is up and running—nationally and abroad. Some men have had their name on the list from the inception of The Network in 1992 and have found it very encouraging to be in written or telephone communication with a variety of men both here and abroad. Others have entered their name into The Network just until they have established a personal network of men with whom they correspond and exchange information and support. The master file of The Network is maintained at the international office of NORM in Concord, California, and those who are interested in this sort of support may contact that office (see listing under RESOURCES).

### **Support Groups for Men Wounded by Circumcision**

The NORM group which meets regularly in the San Francisco Bay Area has given some of us an opportunity to see firsthand the support and comradery which men with common experience and purpose can offer each other. Actually, we as a nation have become acutely aware of the contribution of some of the better known self-help groups: AA, MADD, ACA, etc. As a matter of fact, the number of groups declaring themselves to be '*Something Anonymous*,' from shoppers and gamblers to abusers, is growing every year. If one adds to all of these the various victims' groups meeting across the nation, the overall number of men, women, and children seeking help within such a setting is truly astronomical. Support groups are indeed a phenomenon of our day. They seem to meet a need for openness and for mutual sharing and caring

which has all but disappeared in other groups and structures—including many families—in our society.

In light of these factors, it is not surprising that men seem to profit from coming together in an atmosphere which assures them that they will not be laughed at for voicing one of their best-kept secrets: they hate being circumcised. That admission in any other arena in this country is apt to get a man laughed at and suspected of being either weird or psychologically unbalanced. Bottom line, the overriding purpose of such a support group is to provide a safe and supportive environment where the wounds of circumcision are taken seriously and where information, help, and encouragement are available.

Some men come to the group not so much to launch directly into a restoration program as simply to be in an atmosphere where telling how violated they feel by circumcision is understood. Others are there because they want information and encouragement relative to their restoration program. At the meetings, these men are given opportunity to ask questions, which are frequently about some aspect of the skin-expansion system. Their questions often lead to group discussion and informal commiseration about some particular or individual's problem. There's a lot of 'boy-do-I-know-how-that-feels' support both given and received. As a psychologist, I am very impressed, after four years, by the general stature and results of the support meetings.

On the whole, there seems to be about the same cross section of humanity in the NORM group as I've noticed in other groups. Some of the men you meet become friends; others are men with whom you have nothing in common aside from the issue which brought you all together. I've seen both strong, self-directed individuals and truly wounded individuals attend the group. In short, the composition of the group seems to be like most any other group brought together by a common experience.

The issue of sexual preference is often asked about by men inquiring into the nature and activities of a NORM group. Sexual orientation is not asked about nor talked about. It is understood that there is no sexual activity of any kind at the meetings. More importantly, none has ever been suggested or hinted at in any meeting I've attended. If some men have come to a meeting with less than serious intentions, the atmosphere and manner in which the meetings are conducted would certainly discourage them from coming again.

In the first edition, I expressed the hope that such support groups would become common "across the country." I'm happy to report that not only have more than a dozen groups been established in this country but there are now groups abroad as well. For example, word was received in March, 1994, that, "Recently, our self-help support center assisted in starting up a self-help group for circumcised men, probably the first in Europe." That message came from the Trefpunt Zelfhulp organization in Belgium. And in August, 1994, word of "our inaugural meeting" in Adelaide, Australia, arrived to say that more than 30 people attended after newspaper, magazine, and radio announcements made the community aware of the formation of the new group. And NORM of the United Kingdom had 15 men at its first meeting in November, 1994.

The international office of NORM provides guidelines for those interested in organizing a support group for restoring men as well as information on those groups already established (see listing under RESOURCES).

### **Activism: A Good Way to Channel Bad Feelings**

If the medical profession and parents were to hear the depth of the rage and/or despair that some men express about being circumcised, they would no doubt be utterly shocked. It is good both for the individual and for our society that these negative emotions be channeled into positive action. To that end NOHARM was founded in 1992 to give men a voice in this most *male* issue. In addition to the sort of activities discussed in Chapter 12, NOHARM has published an impressive array of documents and matériel to give focus and direction to the concerns of men against routine infant and child circumcision. The documents range from an activist's 'primer' to a kit for 'Field Organizers' to periodic Progress Reports and Action Alerts; and the matériel includes buttons, decals, and T-shirts for those who wish to make a statement. If you despise what the medical profession is allowed to do, in the name of medicine, to the genitals of males in this society, you're invited to get involved. From writing letters to street demonstrations, there's something for everyone who feels that he (or she) cannot remain silent any longer (see listing under RESOURCES).

## Postscript

Writing this book has meant the fulfillment of a long journey for me. The life experiences, the research, and the soul searching which have gone into this writing have caused me to affirm and to reaffirm my own purpose and willingness to stand against the tide. It is an uncomfortable place to stand, especially when the tide is swept along by such formidable voices of authority and convention in our nation. But, if this book gives encouragement to even one other man who has grown up believing that he was the only one who hated what was done to him, it will truly have been worth both the effort and the ridicule from those who do not understand the pain or who need to hide their own.

## Notes

### 1 *Why This Book?*

1. Reuben, David, M.D., *EVERYTHING YOU EVER WANTED TO KNOW ABOUT SEX*, New York, David McKay Co., Inc., 1969.

### 2 *The Natural Penis*

1. Taylor, John, M.B., FRCP, "The Prepuce: What, Exactly, is Removed by Circumcision?," Second International Symposium on Circumcision, San Francisco, April 30 - May 3, 1991.  
Taylor, John, M.B., FRCP, "The Prepuce Defined," Third International Symposium on Circumcision, College Park, MD, May 22-25, 1994.
2. Gairdner, Douglas, D.M., MRCP, "The Fate of the Foreskin," *BRITISH MEDICAL JOURNAL*, vol. 2, December 24, 1949, p. 1433.
3. Ibid.
4. Kaplan, George W., "Circumcision—An Overview," *CURRENT PROBLEMS IN PEDIATRICS*, vol. 7, no. 5, March 1977, p. 23.
5. Ritter, Thomas J., M.D., *SAY NO TO CIRCUMCISION!*, Aptos, CA, Hourglass Book Publishing, 1992, p. 37.
6. Berkeley, B., *FORESKIN*, private publication, 1983, pp. 53-56.

### 3 *The Circumcised American Penis*

1. Wallerstein, Edward, *CIRCUMCISION: AN AMERICAN HEALTH FALLACY*, New York, Springer Publishing Co., 1980, p. 217.
2. Schlossberger, Norman M., M.D., MPH, et al., "Early Adolescent Knowledge and Attitudes About Circumcision: Methods and Implications for Research," *JOURNAL OF ADOLESCENT HEALTH*, vol. 13, no. 4, June 1992, p. 296.
3. Gairdner, Douglas, D.M., MRCP, "The Fate of the Foreskin," *BRITISH MEDICAL JOURNAL*, vol. 2, December 24, 1949, p. 1433.
4. Denniston, George C., M.D., MPH, "First, Do No Harm," First International Symposium on Circumcision, Anaheim, CA, March 1-3, 1989.
5. Ritter, Thomas J., M.D., *SAY NO TO CIRCUMCISION!*, Aptos, CA, Hourglass Book Publishing, 1992, p. 31.
6. Personal correspondence on file at NOCIRC headquarters.
7. Ritter, Thomas J., M.D., *SAY NO TO CIRCUMCISION!*, p. 32.
8. Ibid., p. 37.
9. Ibid.
10. Gilbaugh, James H., Jr., M.D., *ask 'Dr. Private Parts,' MEN'S HEALTH*, vol. 6, no. 11, November 1990, p. 14.
11. Silber, Sherman J., M.D., *THE MALE*, New York, Charles Scribner's Sons, 1981, p. 115.
12. McMillen, S.I., M.D., *NONE OF THESE DISEASES*, 2nd ed., Old Tappan, NJ, Fleming H. Revell Co., 1984, p. 89.

### 4 *Common American Myths About the Penis and Infant Circumcision*

1. Silber, Sherman J., M.D., *THE MALE*, New York, Charles Scribner's Sons, 1981, p. 118.

2. Lewis, Alfred Allan, et al., *THE MALE: HIS BODY, HIS SEX*, Garden City, NY, Anchor Press/Doubleday, 1978, p. 106.
3. McMillen, S.I., M.D., *NONE OF THESE DISEASES*, Westwood, NJ, Fleming H. Revell Co., 1963, p. 20.
4. Taylor, John, M.B., FRCP, "The Prepuce: What, Exactly, is Removed by Circumcision?," Second International Symposium on Circumcision, San Francisco, April 30 - May 3, 1991.  
Taylor, John, M.B., FRCP, "The Prepuce Defined," Third International Symposium on Circumcision, College Park, MD, May 22-25, 1994.
5. Adams, Cecil, *The Straight Dope*, NEW YORK PRESS, no. 6, February 9-15, 1994.
6. Thompson, Hugh C., M.D., et al., "Report of the Ad Hoc Task Force on Circumcision," *PEDIATRICS*, vol. 56, no. 4, October 1975, p. 611.
7. Ibid., p. 610.
8. Silber, Sherman J., M.D., *THE MALE*, p. 116.
9. Freedman, Lawrence D., M.D., Letter to the Editor, *JOURNAL OF THE AMERICAN MEDICAL ASSOCIATION*, vol. 214, no. 12, December 21, 1970, p. 2194.
10. Fleiss, Paul M., M.D., MPH, Letter to the Editor, *TRUTH SEEKER*, vol. 1, no. 3, July/August 1989, p. 46.
11. Preston, E. Noel, Captain, M.C., USAF, "Whither the Foreskin?," *JOURNAL OF THE AMERICAN MEDICAL ASSOCIATION*, vol. 213, no. 11, September 14, 1970, p. 1857.
12. Gairdner, Douglas, D.M., MRCP, "The Fate of the Foreskin," *BRITISH MEDICAL JOURNAL*, vol. 2, December 24, 1949, p. 1434.
13. Øster, Jakob, M.D., "Further Fate of the Foreskin," *ARCHIVES OF DISEASE IN CHILDHOOD*, vol. 43, no. 228, April 1968, pp. 200-202.
14. Fink, Aaron J., M.D., "In Defense of Circumcision," cited by Edward Wallerstein in *CIRCUMCISION: INFORMATION, MISINFORMATION, DISINFORMATION*, San Anselmo, CA, NOCIRC, 1986, p. 4.
15. Wallerstein, Edward, *CIRCUMCISION: AN AMERICAN HEALTH FALLACY*, New York, Springer Publishing Co., 1980, p. 127.
16. Spach, David H., M.D., et al., "Lack of Circumcision Increases the Risk of Urinary Tract Infection in Young Men," *JOURNAL OF THE AMERICAN MEDICAL ASSOCIATION*, vol. 267, no. 5, February 5, 1992, pp. 679-681.
17. Wiswell, Thomas E., M.D., et al., "Circumcision in Children Beyond the Neonatal Period," *PEDIATRICS*, vol. 92, no. 6, December 1993, pp. 791-793.
18. Thompson, Robert S., M.D., "Is Routine Circumcision Indicated in the Newborn?: An Opposing View," *THE JOURNAL OF FAMILY PRACTICE*, vol. 31, no. 2, 1990, pp. 189-196.
19. Ganiats, Theodore G., M.D., et al., "Routine Neonatal Circumcision: A Cost-Utility Analysis," *MEDICAL DECISION MAKING*, vol. 11, no. 4, October/December 1991, pp. 282-293.

20. Lawler, Frank H., M.D., et al., "Circumcision: A Decision Analysis of Its Medical Value," *FAMILY MEDICINE*, vol. 23, no. 8, November/December 1991, pp. 587-593.
21. Chessare, John B., M.D., MPH, "Circumcision: Is the Risk of Urinary Tract Infection Really the Pivotal Issue?," *CLINICAL PEDIATRICS*, vol. 31, no. 2, February 1992, pp. 100-104.
22. Amato, Dante & Garduno-Espinosa, Juan, "Circumcision in the Neonate Male and the Risk of Urinary Tract Infection During the First Year of Life. A Cross Analysis," *BOLETIN MEDICO DEL HOSPITAL INFANTIL DE MEXICO*, vol. 49, no. 10, October 1992, pp. 652-658.
23. Katchandourian, Herant A. & Lunde, Donald T., *FUNDAMENTALS OF HUMAN SEXUALITY*, 2nd ed., New York, Holt, Rinehart & Winston, 1972, p. 27.
24. Schlosberg, Charles, M.D., "Thirty Years of Ritual Circumcisions," *CLINICAL PEDIATRICS*, vol. 10, no. 4, April 1971, p. 206.
25. Rutherford, Frederick W., M.D., *YOU AND YOUR BABY*, New York, Signet Book, 1971, p. 239.
26. Stein, Martin T., et al., "Routine Neonatal Circumcision: The Gap Between Contemporary Policy and Practice," *THE JOURNAL OF FAMILY PRACTICE*, vol. 15, no. 1, July 1982, p. 49.
27. Noble, Elizabeth, P.T., "Psychological Motivation of Choosing Not to Circumcise," Second International Symposium on Circumcision, San Francisco, April 30 - May 3, 1991.
28. Gairdner, Douglas, D.M., MRCP, "The Fate of the Foreskin." Øster, Jakob, M.D., "Further Fate of the Foreskin." Reichelderfer, Thomas E., M.D. & Fraga, Juan R., M.D., "Circumcision," cited by Kenneth S. Shepard, M.D., FAAP, in *CARE OF THE WELL BABY*, 2nd ed., J.B. Lippencott Co., 1968.
- Fleiss, Paul M., M.D., MPH, Letter to the Editor, *TRUTH SEEKER*.
29. Wallerstein, Edward, *WHEN YOUR BABY BOY IS NOT CIRCUMCISED*, Seattle, WA, Pennypress, Inc., 1982.
30. McKay, R.J., "The Newborn Infant," *TEXTBOOK OF PEDIATRICS*, 9th ed., W.E. Nelson, ed., Philadelphia, W.B. Saunders Co., 1969, p. 357.
31. Spence, Sir James, cited by Ronald S. Illingworth, M.D., in *THE NORMAL CHILD*, 8th ed., New York, Churchill Livingstone, 1983, p. 100.
32. Illingworth, Ronald S., M.D., *THE NORMAL CHILD*, 8th ed., New York, Churchill Livingstone, 1983, p. 101.
33. Taguchi, Yosh, M.D., *PRIVATE PARTS*, New York, Doubleday, 1988, pp. 26-28.
34. Wallerstein, Edward, *CIRCUMCISION: AN AMERICAN HEALTH FALLACY*, p. 128.
35. Øster, Jakob, M.D., "Clinical Phenomena Noted by a School Physician Dealing with Healthy Children," *CLINICAL PEDIATRICS*, vol. 15, no. 8, August 1976, p. 748.
36. Gilbaugh, James H., Jr., M.D., *ask 'Dr. Private Parts,' MEN'S HEALTH*, vol. 7, no. 5, May 1991, pp. 6-7.
37. Beaugé, Michel, M.D., *TRAITEMENT MÉDICAL DU PHIMOSIS CONGÉNITAL DEL' ADOLESCENT, [CONSERVATIVE TREATMENT OF PRIMARY PHIMOSIS IN ADOLESCENTS]*, trans. John P. Warren, FRCP], Thesis for the University Diploma of Andrology, Saint-Antoine University, Paris VI, 1990-1991.
- Lafferty, P.M., et al., "Management of Foreskin Problems," *ARCHIVES OF DISEASE IN CHILDHOOD*, vol. 66, 1991, pp. 696-697.
- Ying, He & Zhou, Xiu-hua, "Balloon Dilation Treatment of Phimosis in Boys," *CHINESE MEDICAL JOURNAL*, vol. 104, no. 6, 1991, pp. 491-493.
- Griffiths, D., M.A., FRCS & Frank, J.D., FRCS, "Inappropriate Circumcision Referrals by GPs," *JOURNAL OF THE ROYAL SOCIETY OF MEDICINE*, vol. 85, June 1992, pp. 324-325.
- Kikiros, C.S., et al., "The Response of Phimosis to Local Steroid Application," *PEDIATRIC SURGERY INTERNATIONAL*, vol. 8, 1993, pp. 329-332.
- Wright, J.E., M.B., B.S., FRACS, FACS, "The Treatment of Childhood Phimosis With Topical Steroid," *THE AUSTRALIAN AND NEW ZEALAND JOURNAL OF SURGERY*, vol. 64, no. 5, May 1994, pp. 327-328.
38. Parkash, Satya, "Phimosis and Its Plastic Correction," *JOURNAL OF THE INDIAN MEDICAL ASSOCIATION*, vol. 58, no. 10, May 16, 1972, pp. 389-390.
- Ohjimi, Toshihide, M.D. & Ohjimi, Hiroyuki, M.D., "Special Surgical Techniques for Relief of Phimosis," *THE JOURNAL OF DERMATOLOGIC SURGERY AND ONCOLOGY*, vol. 7, no. 4, April 1981, pp. 326-330.
- Emmett, Anthony J.J., "Z-plasty Reconstruction for Preputial Stenosis—A Surgical Alternative to Circumcision," *AUSTRALIAN PAEDIATRIC JOURNAL*, vol. 18, 1982, pp. 219-220.
- Hoffman, S., et al., "A New Operation for Phimosis: Prepuce-saving Technique with Multiple Y-V-plastics," *BRITISH JOURNAL OF UROLOGY*, vol. 56, 1984, pp. 319-321.
- Wählin, Nils, "'Triple Incision Plasty'. A Convenient Procedure for Preputial Relief," *SCANDINAVIAN JOURNAL OF UROLOGY AND NEPHROLOGY*, vol. 26, no. 2, 1992, pp. 107-110.
- Cuckow, Peter M., et al., "Preputial Plasty: A Good Alternative to Circumcision," *JOURNAL OF PEDIATRIC SURGERY*, vol. 29, no. 4, April 1994, pp. 561-563.
39. Gairdner, Douglas, D.M., MRCP, "The Fate of the Foreskin," p. 1436.
40. Silberner, Joanne & Carey, Joseph, "Circumcision," *U.S. NEWS & WORLD REPORT*, May 30, 1988, p. 68.
41. *Ibid.*
42. Wiswell, Thomas E., Major, M.C., USA & Roscelli, John D., LTC, M.C., USA, "Corroborative Evidence for the Decreased Incidence of Urinary Tract Infections in Circumcised Male Infants," *PEDIATRICS*, vol. 78, no. 1, July 1986, pp. 96-99.
43. Altschul, Martin S., M.D., "Cultural Bias and The Urinary Tract Infection (UTI) Circumcision Controversy," First International Symposium on Circumcision, Anaheim, CA, March 1-3, 1989.
44. Altschul, Martin S., M.D., Letter to the Editor, *PEDIATRICS*, vol. 80, no. 5, November 1987, p. 763.
45. Marino, Leonard J., M.D., Letter to the Editor, *CONTEMPORARY PEDIATRICS*, November 1989, pp. 11-14.
46. Watson, Stan J., M.D., Letter to the Editor, *PEDIATRICS*, vol. 80, no. 5, November 1987, p. 765.
47. Winberg, Jan, et al., "The Prepuce: A Mistake of Nature?," *THE LANCET*, March 18, 1989, p. 598.
48. Romberg, Rosemary, Personal correspondence, cited by Billy Ray Boyd in *CIRCUMCISION: WHAT IT DOES*, San Francisco, Taterhill Press, 1990, p. 17.
49. Jacobs, A.J., "The First Cut," *M MAGAZINE*, vol. 9, no. 12, September 1992, pp. 91-92.
50. Personal communication with NOCIRC staff member (May 8, 1993).

51. Denniston, George C., M.D., MPH, "First, Do No Harm." First International Symposium on Circumcision, Anaheim, CA, March 1-3, 1989.
52. Thompson, Robert S., M.D., "Is Routine Circumcision Indicated in the Newborn?: An Opposing View," p. 194.
53. Knight, J.F., B.A., M.B., B.S., FRACP, "Urinary Tract Infection," CURRENT OPINION IN PEDIATRICS, vol. 3, 1991, p. 43.
54. Snyder, Howard M., III, "To Circumcise or Not," HOSPITAL PRACTICE, January 15, 1991, pp. 204-205.
55. Vermooten, Vincent, M.D., cited by Jane E. Brody in "A Restudy Urged on Circumcision," NEW YORK TIMES, September 20, 1970, p. 19.
56. Eiger, Marvin S., M.D., "The Case for Circumcision," TODAY'S HEALTH, vol. 50, no. 4, April 1972, p. 15.
57. Ravich, Abraham, M.D., PREVENTING V.D. AND CANCER BY CIRCUMCISION, New York, Philosophical Library, 1973.
58. Reuben, David, M.D., HOW TO GET MORE OUT OF SEX, New York, Bantam Books, 1975, p. 6.
59. Fink, Aaron J., M.D., "In Defense of Circumcision," cited by Edward Wallerstein in CIRCUMCISION: INFORMATION, MISINFORMATION, DISINFORMATION, p. 4.
60. Simonsen, J. Neil, M.D., et al., "Human Immunodeficiency Virus Infection Among Men with Sexually Transmitted Diseases," THE NEW ENGLAND JOURNAL OF MEDICINE, vol. 319, no. 5, August 4, 1988, p. 274.
61. Wallerstein, Edward, CIRCUMCISION: AN AMERICAN HEALTH FALLACY, p. 80.
62. Ibid., p. 87.
63. Cook, Linda S., M.S., et al., "Circumcision and Sexually Transmitted Diseases," AMERICAN JOURNAL OF PUBLIC HEALTH, vol. 84, no. 2, February 1994, p. 201.
64. U.S. Public Health Service, cited by Marilyn Milos, R.N., in NOCIRC NEWSLETTER, vol. 2, no. 1, Winter 1987, p. 3.
65. Swadey, John, M.D., Personal correspondence, cited by Marilyn Milos, R.N., in NOCIRC NEWSLETTER, vol. 2, no. 1, Winter 1987, pp. 1 & 3.
66. Curran, James, M.D., Personal correspondence, cited by Marilyn Milos, R.N., in NOCIRC NEWSLETTER, vol. 2, no. 1, Winter 1987, p. 3.
67. McMillen, S.I., M.D., NONE OF THESE DISEASES, p. 19.
68. Silber, Sherman J., M.D., THE MALE, pp. 115-116.
69. Eiger, Marvin S., M.D., "The Case for Circumcision," p. 15.
70. Taguchi, Yosh, M.D., PRIVATE PARTS, pp. 26-27.
71. Speert, Harold, M.D., "Circumcision of the Newborn," OBSTETRICS AND GYNECOLOGY, vol. 2, no. 2, August 1953, p. 167.
72. Wynder, Ernest L., M.D., et al., "A Study of Environmental Factors in Carcinoma of the Cervix," AMERICAN JOURNAL OF OBSTETRICS AND GYNECOLOGY, vol. 68, no. 4, October 1954, p. 1046.
73. McMillen, S.I., M.D., NONE OF THESE DISEASES, 2nd ed., Old Tappan, NJ, Fleming H. Revell Co., 1984, p. 91.
74. Stemer, Rosalie, "Jewish Refugees' Rite of Passage," SAN FRANCISCO CHRONICLE, Sunday Punch, Sunday, December 27, 1992, p. 6.
75. Landers, Ann, "Doctor Adds Women's Concerns to List of Circumcision Benefits," CONTRA COSTA TIMES, Monday, April 12, 1993, p. 5F.
76. Apt, Adolf, "Circumcision and Prostatic Cancer," ACTA MEDICA SCANDINAVICA, vol. 178, fasc. 4, 1965, pp. 493-504.
77. Preston, E. Noel, Captain, M.C., USAF, "Whither the Foreskin?," p. 1857.
78. Wallerstein, Edward, CIRCUMCISION: AN AMERICAN HEALTH FALLACY, p. 104.
79. Ibid., p. 108.
80. Maden, Christopher, Ph.D., et al., "History of Circumcision, Medical Conditions, and Sexual Activity and Risk of Penile Cancer," JOURNAL OF THE NATIONAL CANCER INSTITUTE, vol. 85, no. 1, January 6, 1993, pp. 19-24.
81. Wallerstein, Edward, CIRCUMCISION: AN AMERICAN HEALTH FALLACY, p. 106.
82. Denniston, George C., M.D., MPH, "First, Do No Harm."
83. Taguchi, Yosh, M.D., PRIVATE PARTS, p. 27.
84. Wallerstein, Edward, CIRCUMCISION: AN AMERICAN HEALTH FALLACY, p. 106.
85. Grossman, Elliot, M.D. & Posner, Norman Ames, M.D., "Surgical Circumcision of Neonates: A History of Its Development," OBSTETRICS AND GYNECOLOGY, vol. 58, no. 2, August 1981, p. 245.
86. Pomeranz, Virginia E., M.D. & Schultz, Dodi, THE MOTHERS' MEDICAL ENCYCLOPEDIA, New York, Signet Book, 1972, p. 99.
87. Eiger, Marvin S., M.D., "The Case for Circumcision," p. 15.
88. Wilkes, Edward T., M.D., "Should Your Son Be Circumcised?," PARENTS' MAGAZINE, vol. 34, no. 2, February 1959, p. 50.
89. Rutherford, Frederick W., M.D., YOU AND YOUR BABY, p. 100.
90. Schlosberg, Charles, M.D., "Thirty Years of Ritual Circumcisions," p. 205.
91. Blackmon, Edward B., Jr., M.D., "A Look at Medical Reasons for Circumcision Controversy," THE BEACON JOURNAL, Akron, OH, Sunday, May 29, 1988.
92. Taguchi, Yosh, M.D., PRIVATE PARTS, p. 27.
93. Isenberg, Seymour & Elting, L.M., CONSUMER'S GUIDE TO SUCCESSFUL SURGERY, cited by Edward Wallerstein in CIRCUMCISION: AN AMERICAN HEALTH FALLACY, p. 136.
94. Brazelton, T. Berry, M.D., DOCTOR AND CHILD, New York, Delacourte Press/Seymour Lawrence, 1970, p. 30.
95. "Conference on Infants Studies: The First Experiences of Life," NEW YORK TIMES, March 14, 1978, p. 41.
96. Stang, Howard J., M.D., et al., Local Anesthesia for Neonatal Circumcision," JOURNAL OF THE AMERICAN MEDICAL ASSOCIATION, vol. 259, no. 10, March 11, 1988, p. 1510.
97. Grimes, David A., M.D., "Routine Circumcision of the Newborn Infant: A Reappraisal," AMERICAN JOURNAL OF OBSTETRICS AND GYNECOLOGY, vol. 130, no. 2, January 1978, p. 127.
98. Kirya, Christopher, M.B., Ch.B. & Werthmann, Milton W., Jr., M.D., FAAP, "Neonatal Circumcision and Penile Dorsal Nerve Block—A Painless Procedure," THE JOURNAL OF PEDIATRICS, vol. 92, no. 6, June 1978, p. 998.
99. King, Lowell, M.D., et al., "Circumcision: Rite, Rational, or Both?," PATIENT CARE, March 15, 1978, p. 90.
100. Marchbanks, Howard, M.D., Interview, cited by Rosemary Romberg in CIRCUMCISION: THE PAINFUL DILEMMA, South Hadley, MA, Bergin & Garvey Publisher, Inc., 1985, p. 134.
101. Ibid., p. 135.
102. Wall, Roscoe L., Jr., M.D., "Routine Circumcision? Recent Trends and Concepts," NORTH CAROLINA MEDICAL JOURNAL, vol. 29, no. 3, March 1968, p. 104.
103. Taguchi, Yosh, M.D., PRIVATE PARTS, p. 27.



104. Snyder, James L., M.D., FACS, Presentation to the California Medical Association Scientific and Educational Activities Committee, 118th Annual Session and Western Scientific Assembly, Anaheim, CA, March 4, 1989.
105. Wallerstein, Edward, *CIRCUMCISION: AN AMERICAN HEALTH FALLACY*, p. 149.  
Denton, John, M.D., et al., "Circumcision Complication," *CLINICAL PEDIATRICS*, vol. 17, no. 3, March 1978, p. 285.
106. Reichelderfer, Thomas E., M.D. & Fraga, Juan R., M.D., "Circumcision," cited by Kenneth S. Shepard, M.D., FAAP, in *CARE OF THE WELL BABY*, p. 302.
107. Levitt, Selwyn B., M.D., et al., "Iatrogenic Microphallus Secondary to Circumcision," *UROLOGY*, vol. 8, no. 5, November 1976, p. 473.
108. Silber, Sherman J., M.D., *THE MALE*, p. 117.
109. Money, John, Ph.D. & Tucker, Patricia, *SEXUAL SIGNATURES*, Boston, Little, Brown and Co., 1975, pp. 91-98.
110. Seabrook, Charles, "Lawyers: \$22.8 million to be Paid Over Botched Circumcision," *THE ATLANTA CONSTITUTION*, Tuesday, March 12, 1991, pp. A1 & A6.
111. Romberg, Rosemary, *CIRCUMCISION: THE PAINFUL DILEMMA*, South Hadley, MA, Bergin & Garvey Publisher, Inc., 1985, p. 161.
112. "Should Your Child Be Circumcised?," *FAMILY HEALTH*, cited by Anne Briggs in *CIRCUMCISION: WHAT EVERY PARENT SHOULD KNOW*, Earlysville, VA, Birth and Parenting Publications, Inc., 1985, p. 89.
113. Briggs, Anne, *CIRCUMCISION: WHAT EVERY PARENT SHOULD KNOW*, Earlysville, VA, Birth and Parenting Publications, Inc., 1985, p. 89.
114. Gellis, Sydney S., M.D., "Circumcision," *AMERICAN JOURNAL OF DISEASES OF CHILDHOOD*, vol. 132, no. 12, December 1978, p. 1168.
115. Streitfeld, Hank, M.D., "Should Circumcision Be Routine?," *PARENTS' PRESS*, March 5, 1981, p. 5.
116. Rogers, Peggy & Wallace, Richard, "Infant Bleeds to Death After Being Circumcised," *THE MIAMI HERALD*, Saturday, June 26, 1993, p. 1B.
117. Silber, Sherman J., M.D., *THE MALE*, pp. 118-119.
118. Masters, William H. & Johnson, Virginia E., *HUMAN SEXUAL RESPONSE*, Boston, Little, Brown and Co., 1966, pp. 189-191.
119. Personal correspondence on file at NOCIRC headquarters.

### **5 Common Circumcision Myths Which Cloud Social Issues**

1. Silber, Sherman J., M.D., *THE MALE*, New York, Charles Scribner's Sons, 1981, p. 118.
2. Taguchi, Yosh, M.D., *PRIVATE PARTS*, New York, Doubleday, 1988, p. 27.
3. Stoddard, Kathy, "Circumcision," *AMERICAN BABY*, March 1991, p. 84.
4. James, William, M.D., cited in "Circumcision: Is it a Health Benefit?," *CONSUMER REPORTS: HEALTH LETTER*, vol. 1, no. 4, December 1989.
5. Neifert, Marianne, M.D., *DR. MOM*, New York, Signet Book, 1986, p. 39.
6. Fink, Aaron J., M.D., *CIRCUMCISION: A PARENT'S DECISION FOR LIFE*, Mountain View, CA, Kavanah Publishing Co., 1988.
7. Silber, Sherman J., M.D., *THE MALE*, p. 119.
8. Van Buren, Abigail, "Don't Pierce Those Baby Ears," *Dear Abby*, *SAN FRANCISCO CHRONICLE*, Wednesday, February 6, 1991, p. E12.

9. Thornton, Jim, "Reverse Circumcision," *MEN'S CONFIDENTIAL*, October 1993, pp. 10-11.
10. *Male Box*, *MEN'S CONFIDENTIAL*, December 1993, p. 6.
11. Hammond, Tim, ed., "1992 'Journeymen' Body Image Survey," *AWAKENINGS*, San Francisco, NOHARM, 1994, pp. 73-75.
12. Schlossberger, Norman M., M.D., MPH, et al., "Early Adolescent Knowledge and Attitudes About Circumcision: Methods and Implications for Research," *JOURNAL OF ADOLESCENT HEALTH*, vol. 13, no. 4, June 1992, p. 296.
13. Personal correspondence on file at NORM headquarters.
14. Spock, Benjamin, M.D., "Circumcision—It's Not Necessary," *REDBOOK*, April 1989, p. 53.
15. Spock, Benjamin, M.D., *BABY AND CHILD CARE*, New York, Pocket Books, 1946, p. 18.
16. Gershman, Dr. Martin, *LOS ANGELES TIMES*, cited by Marilyn Milos, R.N., in *NOCIRC NEWSLETTER*, vol. 2, no. 1, Winter 1987, p. 5.
17. Reinisch, June, Ph.D., Interview, *Real Personal*, CNBC, April 14, 1994, transc., pp. 12-13.
18. Wolfson, Dr. Jerome, *PITTSBURGH POST GAZETTE*, cited by Marilyn Milos, R.N., in *NOCIRC NEWSLETTER*, vol. 2, no. 1, Winter 1987, p. 5.
19. Alcalen, Dr. Erlinda, *BILOXI SUN HERALD*, cited by Marilyn Milos, R.N., in *NOCIRC NEWSLETTER*, vol. 2, no. 1, Winter 1987, p. 5.
20. Kelley, Dr. Charles, *ALLENTOWN MORNING CALL*, cited by Marilyn Milos, R.N., in *NOCIRC NEWSLETTER*, vol. 2, no. 1, Winter 1987, p. 5.
21. Gentile, Dr. Anthony, *PITTSBURGH POST GAZETTE*, cited by Marilyn Milos, R.N., in *NOCIRC NEWSLETTER*, vol. 2, no. 1, Winter 1987, p. 5.
22. Personal correspondence on file at UNCIRC headquarters.
23. Erickson, John A., *MAKING AMERICA SAFE FOR FORESKINS*, private publication, 1989, p. 3.
24. Strand, John, Personal correspondence, cited by Rosemary Romberg in *CIRCUMCISION: THE PAINFUL DILEMMA*, South Hadley, MA, Bergin & Garvey Publisher, Inc., 1985, pp. 194-197.
25. Mohl, Paul C., M.D., et al., "Prepuce Restoration Seekers: Psychiatric Aspects," *ARCHIVES OF SEXUAL BEHAVIOR*, vol. 10, no. 4, 1981, p. 383.
26. Money, John, Ph.D., "Sexology, Body Image, Foreskin Restoration, and Bisexual Status," *THE JOURNAL OF SEX RESEARCH*, vol. 28, no. 1, February 1991, pp. 145-156.

### **6 The Development of Circumcision in Judaism**

1. DeMeo, James, Ph.D., "Desertification and the Origins of Armoring: The Saharasian Connection, Part V," *JOURNAL OF ORGONOMY*, vol. 24, no. 1, 1990, p. 103.
2. Kohler, Kaufmann, Ph.D., "Circumcision," *THE JEWISH ENCYCLOPEDIA*, New York, KTAV Publishing House, Inc., 1964, p. 93.
3. Ibid.
4. Wallerstein, Edward, *CIRCUMCISION: AN AMERICAN HEALTH FALLACY*, New York, Springer Publishing Co., 1980, p. 158.
5. Hand, Eugene A., M.D., "History of Circumcision," *JOURNAL OF MICHIGAN STATE MEDICAL SOCIETY*, vol. 49, no. 5, May 1950, p. 573.
6. Kohler, Kaufmann, Ph.D., "Circumcision," p. 93.
7. Wallerstein, Edward, "The Case of the Marble Foreskin," *FORUM*, September 1983, pp. 53-55.
8. Kohler, Kaufmann, Ph.D., "Circumcision," p. 93.

9. Edwardes, Allen, *EROTICA JUDAICA*, New York, The Julian Press, Inc., 1967, pp. 114-117.
  10. Maimonides, Moses, *THE GUIDE FOR THE PERPLEXED*, New York, Dover Publications, Inc., 1956, p. 378.
  11. Bryk, Felix, *SEX & CIRCUMCISION*, North Hollywood, CA, Brandon House, 1967, pp. 49-50.
  12. Weiss, Charles, "A Worldwide Survey of the Current Practice of Milah (Ritual Circumcision)," *JEWISH SOCIAL STUDIES*, January 1962, p. 47.
  13. "Circumcision, A Guide to the Methods to be Employed by Mohalim," New York: Department of Health, City of New York, cited by Edward Wallerstein in *CIRCUMCISION: AN AMERICAN HEALTH FALLACY*, p. 159.
  14. Snowman, L.V., "The Surgery of Ritual Circumcision," 3rd ed., cited by Edward Wallerstein in *CIRCUMCISION: AN AMERICAN HEALTH FALLACY*, p. 159.
  15. Wallerstein, Edward, *CIRCUMCISION: AN AMERICAN HEALTH FALLACY*, p. 159.
  16. Hand, Eugene A., M.D., "History of Circumcision," p. 574.
  17. Bryk, Felix, *SEX & CIRCUMCISION*, p. 55.
  18. Bryk, Felix, *CIRCUMCISION IN MAN AND WOMAN*, New York, American Ethnological Press, 1934, pp. 219-220.
  19. Maimonides, Moses, *THE GUIDE FOR THE PERPLEXED*, pp. 378-379.
  20. Panati, Charles, *PANATI'S EXTRAORDINARY ENDINGS OF PRACTICALLY EVERYTHING AND EVERYBODY*, New York, Harper & Row, Publishers, 1989, p. 313.
  21. James, Theodore, M.B., Ch.B., "Philo on Circumcision," *SOUTH AFRICA MEDIESE TYDSKRIF*, vol. 50, no. 36, 21 Augustus 1976, p. 1410.
  22. Maimonides, Moses, *THE GUIDE FOR THE PERPLEXED*, p. 378.
  23. Isaac, Erich, "The Enigma of Circumcision," *COMMENTARY*, vol. 43, no. 1, January 1967, p. 52.
  24. *Ibid.*, p. 51.
  25. McMillen, S.I., M.D., *NONE OF THESE DISEASES*, Westwood, NJ, Fleming H. Revell Co., 1963, p. 21.
  26. Weiss, Charles, "A Worldwide Survey of the Current Practice of Milah (Ritual Circumcision)," pp. 40-41.
  27. Romberg, Rosemary, *CIRCUMCISION: THE PAINFUL DILEMMA*, South Hadley, MA, Bergin & Garvey Publisher, Inc., 1985, p. 51.
  28. *Ibid.*, p. 44.
  29. "Rating the Circumcisers," *NEWSWEEK*, vol. 80, no. 10, September 4, 1972, p. 67.
  30. Frand, M., et al., Letter to the Editor, *PEDIATRICS*, vol. 54, no. 4, October 1974, p. 521.
  31. Cohen, Herman A., M.D., et al., "Postcircumcision Urinary Tract Infection," *CLINICAL PEDIATRICS*, vol. 31, no. 6, June 1992, pp. 322-324.
  32. Eason, Julian D., et al., "Male Ritual Circumcision Resulting in Acute Renal Failure," *BRITISH MEDICAL JOURNAL*, vol. 309, September 10, 1994, pp. 660-661.
  33. Edwardes, Allen, *EROTICA JUDAICA*, pp. 109 & 142.
  34. Weiss, Charles, M.D., Ph.D., "Ritual Circumcision," *CLINICAL PEDIATRICS*, vol. 1, no. 1, October 1962, p. 71.
  35. Joseph, Max, "Circumcision," *THE UNIVERSAL JEWISH ENCYCLOPEDIA*, New York, The Universal Jewish Encyclopedia, Inc., 1941, p. 216.
  36. Goldman, Ronald F., "Circumcision: New Information Raises Questions," *JEWISH NEWS*, September 1990, and "Is Circumcision Advisable?," *THE JEWISH TIMES*, March 21, 1991.
  37. Moss, Lisa Braver, B.A., "The Jewish Roots of Anti-Circumcision Arguments," Second International Symposium on Circumcision, San Francisco, April 30 - May 3, 1991.
  38. Rothenberg, Moshe, CSW, "Ending Circumcision in the Jewish Community?," Second International Symposium on Circumcision, San Francisco, April 30 - May 3, 1991.
  39. Rothenberg, Moshe, CSW, "Jewish Roots of Circumcision," Third International Symposium on Circumcision, College Park, MD, May 22-25, 1994.
  40. Pollack, Miriam, "Circumcision: A Jewish Feminist Perspective," Third International Symposium on Circumcision, College Park, MD, May 22-25, 1994.
  41. Moss, C.L., "The Unkindest Cut," *SAN FRANCISCO EXAMINER, Image*, Sunday, December 15, 1991, pp. 9 & 42.
- 7 Foreskin Restoration Among the Jews**
1. Edwardes, Allen, *EROTICA JUDAICA*, New York, The Julian Press, Inc., 1967, pp. 107-108.
  2. *Ibid.*, p. 108.
  3. Levin, S., M.B., MRCP, DCH, "Brit Milah: Ritual Circumcision," *SOUTH AFRICAN MEDICAL JOURNAL*, vol. 39, December 11, 1965, p. 1125.
  4. Bryk, Felix, *CIRCUMCISION IN MAN AND WOMAN*, New York, American Ethnological Press, 1934, pp. 225-227.
  5. Edwardes, Allen, *EROTICA JUDAICA*, pp. 109-110.
  6. *Ibid.*, p. 110.
  7. Rubin, Jody P., M.A., "Celsus' Decircumcision Operation," *UROLOGY*, vol. 16, no. 1, July 1980, p. 124.
  8. Edwardes, Allen, *EROTICA JUDAICA*, pp. 142-145.
  9. *Ibid.*, pp. 141-142.
  10. Schneider, T., M.D., FRCP, "Circumcision and 'Uncircumcision,'" *SOUTH AFRICAN MEDICAL JOURNAL*, March 27, 1976, p. 557.
  11. *Ibid.*
  12. *Ibid.*
  13. Edwardes, Allen, *EROTICA JUDAICA*, pp. 112-113.
  14. Tushnet, Leonard, M.D., "Uncircumcision," *MEDICAL TIMES*, vol. 93, no. 6, June 1965, p. 589.
  15. *Ibid.*
  16. Edwardes, Allen, *EROTICA JUDAICA*, p. 115.
  17. Schneider, T., M.D., FRCP, "Circumcision and 'Uncircumcision,'" p. 558.
  18. Tushnet, Leonard, M.D., "Uncircumcision," pp. 590-593.
  19. Feriz, H., "Eine einfache Methode zur Plastik des Präputiums nach radikaler (ritueller) Zirkumzision," ["A Simple Method for Preputial Plastic Replacement After Radical (Ritual) Circumcision," trans. Tim Sally & Bernd Vey], *MÜNCHENER MEDIZINISCHE WOCHENSCHRIFT*, vol. 31, August 3, 1962, pp. 1406-1407.
  20. Arnold, Michael, "Weighty Approach to Reverse Circumcision," *THE JERUSALEM REPORT*, March 25, 1993, pp. 6 & 8.
  21. Bigelow, Jim, Ph.D., "Uncircumcising: Undoing the Effects of an Ancient Practice in a Modern World," *MOTHERING*, no. 71, Summer 1994, pp. 56-61.
- 8 America's 100-Year Infatuation with Circumcision**
1. Gardner, A.M.N., "Circumcision and Sand," *JOURNAL OF THE ROYAL SOCIETY OF MEDICINE*, vol. 84, June 1991, p. 387.
  2. Fink, Aaron J., M.D., "Circumcision and Sand," *JOURNAL OF THE ROYAL SOCIETY OF MEDICINE*, vol. 84, November 1991, p. 696.
  3. Van Biema, David, "Miracles, U.S.A.," *LIFE*, vol. 14, no. 9, July 1991, p. 38.

4. Spitz, René A., M.D., "Authority and Masturbation: Some Remarks on a Bibliographical Investigation," cited by Irwin M. Marcus, M.D. & John J. Francis, M.D., in *MASTURBATION: FROM INFANCY TO SENESCENCE*, New York, International Universities Press, Inc., 1975, p. 386.
  5. Berkeley, B., cited by Rosemary Romberg in *CIRCUMCISION: THE PAINFUL DILEMMA*, South Hadley, MA, Bergin & Garvey Publisher, Inc., 1985, p. 97.
  6. Paige, Karen Ericksen, "The Ritual of Circumcision," *HUMAN NATURE*, May 1978, p. 42.
  7. Berkeley, B., cited by Rosemary Romberg in *CIRCUMCISION: THE PAINFUL DILEMMA*, p. 97.
  8. Paige, Karen Ericksen, "The Ritual of Circumcision," p. 42.
  9. Remondino, P.C., M.D., *HISTORY OF CIRCUMCISION*, New York, The F.A. Davis Co., Publishers, 1900, title page.
  10. *Ibid.*, pp. 254-255.
  11. Spratling, Edgar J., M.D., "Masturbation in the Adult," *MEDICAL RECORD*, vol. 48, no. 13, September 28, 1895, pp. 442-443.
  12. Spitz, René A., M.D., "Authority and Masturbation: Some Remarks on a Bibliographical Investigation," p. 394.
  13. Wallerstein, Edward, *CIRCUMCISION: AN AMERICAN HEALTH FALLACY*, New York, Springer Publishing Co., 1980, p. 37.
  14. Hosken, Fran P., "Genital and Sexual Mutilation of Females," *WOMEN'S INTERNATIONAL NETWORK NEWS*, Lexington, MA.
  15. Schultz, Terri, "Female Circumcision: Operation Orgasm," *VIVA*, vol. 2, no. 6, March 1975, pp. 53-54 & 104-105.
  16. Paige, Karen Ericksen, "The Ritual of Circumcision," p. 42.
  17. Schultz, Terri, "Female Circumcision: Operation Orgasm," pp. 53-54 & 104-105.
  18. Rathmann, W.G., M.D., "Female Circumcision, Indications and a New Technique," *GP*, vol. 20, no. 3, September 1959, pp. 115-120.
  19. McDonald, C.F., M.D., "Circumcision of the Female," *GP*, vol. 18, no. 3, September 1958, p. 98.
  20. Grace, Beth, "Ohio Doctor Charged with Immorality," *MESA TRIBUNE/TEMPE DAILY/CHANDLER ARIZONAN TRIBUNE*, Friday, December 9, 1988, p. A12.
  21. "'Love Surgery' Victim Awarded \$5 million," news release, Dayton, Ohio, June 22, 1991.
  22. Kistler, S.L., M.D., "Rapid Bloodless Circumcision of Male and Female and Its Technic," *JOURNAL OF AMERICAN MEDICAL ASSOCIATION*, vol. 54, no. 22, May 28, 1910, p. 1782.
  23. McMillen, S.I., M.D., *NONE OF THESE DISEASES*, 2nd ed., Old Tappan, NJ, Fleming H. Revell Co., 1984, p. 89.
  24. Personal correspondence on file at UNCIRC headquarters.
  25. Grossman, Elliot A., M.D., *CIRCUMCISION: A Pictorial Atlas of its History, Instrument Development and Operative Techniques*, Great Neck, NY, Todd & Honeywell, Inc., 1982, p. 29.
  26. *Ibid.*, pp. 17-34.
  27. *Ibid.*, p. 13.
  28. *Ibid.*
  29. Levin, S., M.B., MRCP, DCH, "Brit Milah: Ritual Circumcision," *SOUTH AFRICAN MEDICAL JOURNAL*, vol. 39, December 11, 1965, p. 1127.
  30. Romberg, Henry C., M.D., *BRIS MILAH*, New York, Feldheim Publishers, 1982, pp. 52-53.
  31. Grossman, Elliot A., M.D., *CIRCUMCISION: A Pictorial Atlas of its History, Instrument Development and Operative Techniques*, pp. 18-19.
  32. *Ibid.*, pp. 25-26.
  33. *Ibid.*, p. 36.
  34. "Olympic Circumstraint," Brochure, Olympic Medical Corp., Seattle, WA.
  35. Silber, Sherman J., M.D., *THE MALE*, New York, Charles Scribner's Sons, 1981, pp. 49-51.
  36. Taguchi, Yosh, M.D., *PRIVATE PARTS*, New York, Doubleday, 1988, pp. 28-29.
  37. Gilbaugh, James H., Jr., M.D., *ask 'Dr. Private Parts, 'MEN'S HEALTH*, vol. 6, no. 3, March 1990, p. 14.
  38. Gilbaugh, James H., Jr., M.D., *ask 'Dr. Private Parts, 'MEN'S HEALTH*, vol. 6, no. 12, December 1990, p. 14.
  39. Sathaye, U.V., et al., "Skin Bridge—A Complication of Paediatric Circumcision," *BRITISH JOURNAL OF UROLOGY*, vol. 66, no. 2, 1990, p. 214.
  40. Bergeson, Paul S., M.D., et al., "The Inconspicuous Penis," *PEDIATRICS*, vol. 92, no. 6, December 1993, pp. 794-799.
  41. Alter, Gary J., M.D., et al., "Buried Penis as a Contraindication for Circumcision," *JOURNAL OF THE AMERICAN COLLEGE OF SURGEONS*, vol. 178, May 1994, p. 487-490.
- 9 Twentieth Century Christianity and Infant Male Circumcision in America**
1. McMillen, S.I., M.D., *NONE OF THESE DISEASES*, 2nd ed., Old Tappan, NJ, Fleming H. Revell Co., 1984, p. 15.
  2. Gayman, Dan, LO, *CHILDREN... OUR HERITAGE FROM GOD*, Schell City, MO, Church of Israel, 1991, p. 17.
  3. Maimonides, Moses, *THE GUIDE FOR THE PERPLEXED*, New York, Dover Publications, Inc., 1956, p. 378.
  4. Robertson, Pat, Reprint of personal correspondence on file at UNCIRC headquarters.
  5. Kohler, Kaufmann, Ph.D., "Circumcision," *THE JEWISH ENCYCLOPEDIA*, New York, KTAV Publishing House, Inc., 1964, p. 93.
  6. Bigelow, Jim, Ph.D., "Circumcision and Twentieth-Century Christianity," Second International Symposium on Circumcision, San Francisco, April 30 - May 3, 1991.
- 10 Psychological Factors Related to Infant Circumcision**
1. Wallerstein, Edward, *CIRCUMCISION: AN AMERICAN HEALTH FALLACY*, New York, Springer Publishing Co., 1980, p. 135.
  2. Condry, J. & Condry, S., "Sex Differences: A Study of the Eye of the Beholder," *CHILD DEVELOPMENT*, vol. 47, 1976, pp. 812-819.
  3. Goncalves, Fernando, "Abused Kids Become Abusive Managers, Study Says," *THE CONTRA COSTA TIMES*, Monday, October 1, 1990, p. 5C.
  4. Van Biema, David, "The Journey of Our Lives," *LIFE*, October 1991, from David Cohen's *THE CIRCLE OF LIFE: RITUALS FROM THE HUMAN FAMILY ALBUM*, San Francisco, Harper, 1991.
  5. Baldwin, James, *GOING TO MEET THE MAN*, New York, Dial Press, 1965, pp. 243-249.
  6. Silber, Sherman J., M.D., *THE MALE*, New York, Charles Scribner's Sons, 1981, p. 118.
  7. Gelbaum, Ilene, CNM, "Male Newborn Circumcision: The Nurse-Midwifery Model," 35th Annual Meeting of the American College of Nurse-Midwives (ACNM), Atlanta, GA, May 13-14, 1990.
  8. Gelbaum, Ilene, CNM, "Circumcision: Refining a Traditional Surgical Technique," *JOURNAL OF NURSE-MIDWIFERY*, vol. 38, no. 2 (Supplement), March/April 1993, pp. 18S-30S.

9. Taguchi, Yosh, M.D., *PRIVATE PARTS*, New York, Doubleday, 1988, p. 27.
  10. Abcarian, Robin, "Second—Even Third—Thoughts on Circumcision," *LOS ANGELES TIMES*, Sunday, January 16, 1994, pp. E1 & E4.
  11. Kunin, Samuel A., "Base Circumcision Decision on What's Best," *LOS ANGELES TIMES*, Sunday, January 30, 1994, p. E5.
  12. Lightfoot-Klein, Hanny, *PRISONERS OF RITUAL: AN ODYSSEY INTO FEMALE GENITAL CIRCUMCISION IN AFRICA*, New York, Harrington Park Press, 1989, p. 70.
  13. Morgan, David Z., M.D., "Airborne Babies," cited in "A Chuckle a Day Keeps the Doctor Happy," *AMERICAN MEDICAL NEWS*, April 22/29, 1991.
  14. Zweifler, John, M.D., "Teaching Residents Circumcision," *FAMILY MEDICINE*, vol. 26, no. 1, January 1994, pp. 4-5.
  15. Schlosberg, Charles, M.D., "Thirty Years of Ritual Circumcisions," *CLINICAL PEDIATRICS*, vol. 10, no. 4, April 1971, p. 205.
  16. Deutsch, Morton & Krauss, Robert M., *THEORIES IN SOCIAL PSYCHOLOGY*, New York, Basic Books, Inc., 1965, pp. 68-76.
  17. Angell, Rich, Letter to the Editor (unpublished), *LOS ANGELES TIMES*, February 8, 1994.
  18. Noble, Elizabeth, P.T., "Psychological Motivation of Choosing Not to Circumcise," Second International Symposium on Circumcision, San Francisco, April 30 - May 3, 1991.
  19. Cohen, Arthur R., *ATTITUDE CHANGE AND SOCIAL INFLUENCE*, New York, Basic Books, Inc., 1964, pp. 100-120.
  20. Personal correspondence on file at NOCIRC headquarters.
  21. Hoppe, Art, "Penile Enhancement," *SAN FRANCISCO CHRONICLE*, *Sunday Punch*, Sunday, October 3, 1993, p. 1.
  22. Noble, Elizabeth, P.T., Letter to the Editor, *AMERICAN MEDICAL NEWS*, August 5, 1991.
  23. Block, Jeanne H., "Another Look at Sex Differentiation in the Socialization Behavior of Mothers and Fathers," cited by J. Sherman & F.L. Denmark, eds., *PSYCHOLOGY OF WOMEN: FUTURE DIRECTIONS OF RESEARCH*, New York, Psychological Dimensions, 1979.  
Block, Jeanne H., "Differential Premises Arising from Differential Socialization of the Sexes: Some Conjectures," *CHILD DEVELOPMENT*, vol. 54, 1983, pp. 1335-1354.
  24. Personal correspondence on file at UNCIRC headquarters.
  25. Clark, K.B. & Clark, M.P., "Racial Identification and Preference in Negro Children," cited by T.M. Newcomb & E.L. Hartely, eds., in *READINGS IN SOCIAL PSYCHOLOGY*, New York, Holt, 1947.  
Porter, J., *BLACK CHILD, WHITE CHILD: THE DEVELOPMENT OF RACIAL ATTITUDES*, Cambridge, MA, Harvard University Press, 1971.
  26. Ostwald, Peter F. & Peltzman, Philip, "The Cry of the Human Infant," *SCIENTIFIC AMERICAN*, vol. 230, no. 3, March 1974, p. 85.
  27. Brazelton, T. Berry, M.D., *DOCTOR AND CHILD*, New York, Delacourte Press/Seymour Lawrence, 1970, p. 40.
  28. Emde, R.N., et al., "Stress and Neonatal Sleep," *PSYCHOSOMATIC MEDICINE*, vol. 33, 1971, pp. 491-496.
  29. Anders, T.F. & Chalemian, R.J., "The Effect of Circumcision on Sleep-wake States in Human Neonates," *PSYCHOSOMATIC MEDICINE*, vol. 36, 1974, pp. 174-179.
  30. Romberg, Rosemary, *CIRCUMCISION: THE PAINFUL DILEMMA*, South Hadley, MA, Bergin & Garvey Publisher, Inc., 1985, pp. 305-316.
  31. Briggs, Anne, *CIRCUMCISION: WHAT EVERY PARENT SHOULD KNOW*, Earlysville, VA, Birth and Parenting Publications, Inc., 1985, pp. 122-123.
  32. Jacobson, B., et al., "Perinatal Origin of Adult Self-destructive Behavior," *ATCA PSYCHAIR. SCAND.*, vol. 76, 1987, p. 364.
  33. Lilienfeld, Abraham M., M.D., MPH & Graham, Saxon, Ph.D., "Validity of Determining Circumcision Status by Questionnaire as Related to Epidemiological Studies of Cancer of the Cervix," *JOURNAL OF THE NATIONAL CANCER INSTITUTE*, vol. 21, no. 4, October 1958, p. 715.
  34. Festinger, Leon, "The Psychological Effects of Insufficient Reward," *AMERICAN PSYCHOLOGIST*, vol. 16, 1961, pp. 1-11.
- 11 *Why Men Today Want to Uncircumcise***
1. Schoen, Edgar J., Letter to the Editor, *JOURNAL OF UROLOGY*, vol. 146, no. 6, December 1991, p. 1619.
  2. BUFF Statistics, March 1991, on file at UNCIRC headquarters.
- 12 *The Modern Foreskin Restoration Movement***
1. Penn, Jack, FRCS, "Penile Reform," *BRITISH JOURNAL OF PLASTIC SURGERY*, vol. 16, 1963, p. 287.
  2. Mercier, O.F., "Restauration d'un Prépuce," ["Restauration of a Prepuce Removed by Circumcision," trans. Frederick Hodges], *L'UNION MÉDICALE DU CANADA*, vol. 3, no. 4, April 1898, pp. 264-266.
  3. Penn, Jack, FRCS, "Penile Reform," pp. 287-288.
  4. Strand, John, Personal correspondence, cited by Rosemary Romberg in *CIRCUMCISION: THE PAINFUL DILEMMA*, South Hadley, MA, Bergin & Garvey Publisher, Inc., 1985, pp. 194-197.
  5. Personal correspondence on file at UNCIRC headquarters.
  6. Feins, Neil R., "A New Incision for Penile Surgery," *JOURNAL OF PEDIATRIC SURGERY*, vol. 16, no. 6, December 1981, pp. 817-819.
  7. Greer, Donald M., Jr., et al., "A Technique for Foreskin Reconstruction and Some Preliminary Results," *THE JOURNAL OF SEX RESEARCH*, vol. 18, no. 4, November 1982, pp. 324-330.
  8. Goodwin, W.E. & Thelan, H.M., "Plastic Reconstruction of Penile Skin: Implantation of the Penis into the Scrotum," *JOURNAL AMERICAN MEDICAL ASSOCIATION*, vol. 144, 1950, p. 384.  
Goodwin, W.E. & Scott, W.W., "Phalloplasty," *THE JOURNAL OF UROLOGY*, vol. 68, 1952, p. 903.
  9. Goodwin, Willard E., "Uncircumcision: A Technique for Plastic Reconstruction of a Prepuce After Circumcision," *THE JOURNAL OF UROLOGY*, vol. 144, November 1990, pp. 1203-1205.
  10. *ENCYCLOPEDIA OF ASSOCIATIONS*, 19th ed., 1985, pp. 907-908.
  11. Wallerstein, Edward, *CIRCUMCISION: AN AMERICAN HEALTH FALLACY*, New York, Springer Publishing Co., 1980.
  12. Romberg, Rosemary, *CIRCUMCISION: THE PAINFUL DILEMMA*, South Hadley, MA, Bergin & Garvey Publisher, Inc., 1985.
  13. Briggs, Anne, *CIRCUMCISION: WHAT EVERY PARENT SHOULD KNOW*, Earlysville, VA, Birth and Parenting Publications, Inc., 1985.

14. Boyd, Billy Ray, *CIRCUMCISION: WHAT IT DOES*, San Francisco, Taterhill Press, 1990.
  15. Ritter, Thomas J., M.D., *SAY NO TO CIRCUMCISION!*, Aptos, CA, Hourglass Book Publishing, 1992.
  16. Cromie, William J., M.D., MBA & Kelleher, Ruth E., R.N., BSN, "Circumcision," *JOURNAL OF THE AMERICAN MEDICAL ASSOCIATION*, vol. 269, no. 4, January 27, 1993, pp. 529-530.
  17. Greer, Donald M., M.D., Review of "The Joy of Uncircumcising! Restore Your Birthright and Maximize Sexual Pleasure," *PLASTIC AND RECONSTRUCTIVE SURGERY*, vol. 90, no. 6, December 1992, p. 1117.
  18. Taylor, Laura R., CNM, MSN, Review of "The Joy of Uncircumcising! Restore Your Birthright and Maximize Sexual Pleasure," *JOURNAL OF NURSE-MIDWIFERY*, vol. 38, no. 6, November/December 1993, pp. 373-374.
  19. "The Joy of Uncircumcising! Restore Your Birthright and Maximize Sexual Pleasure," Review by *BRITISH JOURNAL OF UROLOGY*, vol. 73, 1994, p. 335.
  20. Kirby, Roger S., Review of "The Joy of Uncircumcising! Restore Your Birthright and Maximize Sexual Pleasure," *BRITISH MEDICAL JOURNAL*, vol. 309, September 10, 1994, p. 679.
  21. Boyd, Billy Ray, *CIRCUMCISION: WHAT IT DOES*, San Francisco, Taterhill Press, 1990, pp. 93-95.
- 13 Skin Expansion: How It Works and What It Provides**
1. Marcus, Jeffrey, MPH, et al., "Tissue Expansion: Past, Present, and Future," *JOURNAL OF THE AMERICAN ACADEMY OF DERMATOLOGY*, vol. 23, no. 5, pt. 1, November 1990, p. 814.
  2. Argenta, Louis C., M.D. & Austad, Eric David, M.D., "Preface: Tissue Expansion," *CLINICS IN PLASTIC SURGERY*, vol. 14, no. 3, July 1987, p. xi.
  3. Goodman, Terri, R.N., et al., "Tissue Expansion: A New Modality in Reconstructive Surgery," *AORN JOURNAL*, vol. 46, no. 2, August 1987, p. 198.
  4. Cohen, Mimis & Marschall, Michael, "Tissue Expansion: An Alternative Technique in Reconstructive Surgery," 1990 *SURGICAL ANNUAL*, Chicago, University of Illinois College of Medicine, vol. 22, pp. 347-348.
  5. Austad, Eric David, M.D., "The Origin of Expanded Tissue," *CLINICS IN PLASTIC SURGERY*, vol. 14, no. 3, July 1987, p. 433.
  6. Olenius, Michael, M.D., et al., "Mitotic Activity in Expanded Human Skin," *PLASTIC AND RECONSTRUCTIVE SURGERY*, vol. 91, no. 2, February 1993, p. 215.
  7. Pasyk, Krystyna A., M.D., Ph.D., et al., "Quantitative Analysis of the Thickness of Human Skin and Subcutaneous Tissue Following Controlled Expansion with a Silicone Implant," *PLASTIC AND RECONSTRUCTIVE SURGERY*, vol. 81, no. 4, April 1988, p. 522.
  8. Matturri, L., M.D., et al., "Long-Term Histopathologic Evaluation of Human Expanded Skin," *PLASTIC AND RECONSTRUCTIVE SURGERY*, vol. 90, no. 4, October 1992, p. 641.
  9. Goodwin, Willard E., "Uncircumcision: A Technique for Plastic Reconstruction of a Prepuce After Circumcision," *THE JOURNAL OF UROLOGY*, vol. 144, November 1990, p. 1204.
  10. Still, Eugene F., II, M.D. & Goodman, R. Cole, M.D., "Total Reconstruction of a Two-Compartment Scrotum by Tissue Expansion," *PLASTIC AND RECONSTRUCTIVE SURGERY*, vol. 85, no. 5, May 1990, pp. 805-808.
11. Lattimer, John K., M.D., D.Sc. & Stalneck, Michael C., M.D., "Tissue Expansion of Underdeveloped Scrotum to Accommodate Large Testicular Prosthesis," *UROLOGY*, vol. 33, no. 1, January 1989, pp. 6-9.
  12. Gilbaugh, James H., Jr., M.D., *ask 'Dr. Private Parts,' MEN'S HEALTH*, vol. 7, no. 9, September 1991, p. 14.
  13. Ritter, Thomas J., M.D., *SAY NO TO CIRCUMCISION!*, Aptos, CA, Hourglass Book Publishing, 1992, p. 37.
  14. Personal correspondence on file at UNCIRC headquarters.
- 18 Alternative Skin-Expansion Innovations**
1. Bigelow, Jim, Personal interview at UNCIRC headquarters, 1991.
  2. Edell, Dean, M.D., cited by Thomas J. Ritter, M.D., in *SAY NO TO CIRCUMCISION!*, Aptos, CA, Hourglass Book Publishing, 1992, p. 45.
- 20 Trends and Options in Surgical Foreskin Reconstruction**
1. Hall, Robert G., "Epispasm: Circumcision in Reverse," *BIBLE REVIEW*, August 1992, pp. 53-56.
  2. Newton, Lancelot, Letter to the Editor, *THE LANCET*, October 26, 1889, p. 886.  
Spencer, Walter G., Letter to the Editor, *THE LANCET*, November 2, 1889, p. 942.  
Meeres, Edward E., M.D., Letter to the Editor, *THE LANCET*, November 30, 1889, p. 1147.  
Mercier, O.F., "Restauration d'un Prépuce," ["Restoration of a Prepuce Removed by Circumcision," trans. Frederick Hodges], *L'UNION MÉDICALE DU CANADA*, vol. 3, no. 4, April 1898, pp. 264-266.
  3. Emmett, Anthony J.J., "Z-plasty Reconstruction for Preputial Stenosis—A Surgical Alternative to Circumcision," *AUSTRALIAN PAEDIATRIC JOURNAL*, vol. 18, 1982, pp. 219-220.
  4. Hoffman, S., et al., "A New Operation for Phimosis: Prepuce-saving Technique with Multiple Y-V-plasties," *BRITISH JOURNAL OF UROLOGY*, vol. 56, 1984, pp. 319-321.
  5. Personal correspondence on file at NOCIRC headquarters.
  6. Personal correspondence on file at UNCIRC headquarters.
  7. Feriz, H., "Eine einfache Methode zur Plastik des Präputiums nach radikaler (ritueller) Zirkumzision," ["A Simple Method for Preputial Plastic Replacement After Radical (Ritual) Circumcision," trans. Tim Sally & Bernd Vey], *MÜNCHENER MEDIZINISCHE WOCHENSCHRIFT*, vol. 31, August 3, 1962, pp. 1406-1407.
  8. Greer, Donald M., Jr. & Mohl, Paul C., M.D., "Foreskin Reconstruction: A Preliminary Report," *SEXUAL MEDICINE TODAY*, April 1982, pp. 17 & 21.  
Greer, Donald M., Jr., et al., "A Technique for Foreskin Reconstruction and Some Preliminary Results," *THE JOURNAL OF SEX RESEARCH*, vol. 18, no. 4, November 1982, pp. 324-330.
  9. Goodwin, Willard E., "Uncircumcision: A Technique for Plastic Reconstruction of a Prepuce After Circumcision," *THE JOURNAL OF UROLOGY*, vol. 144, November 1990, pp. 1203-1205.
  10. Lynch, M.J. & Pryor, J.P., "Uncircumcision: A One-stage Procedure," *BRITISH JOURNAL OF UROLOGY*, vol. 72, no. 2, August 1993, pp. 257-258.

11. Goodwin, Willard E., "Uncircumcision: A Technique for Plastic Reconstruction of a Prepuce After Circumcision," p. 1204.
  12. "Skin Deep," DISCOVER, August 1991, p. 16.
  13. Angell, Dwight E.M., "Infant Foreskins Appear to Aid Healing of Chronic Adult Wounds," DETROIT NEWS AND FREE PRESS, Monday, July 5, 1993, pp. 1A & 4A.
  14. Ibid., p. 4A.
  15. O'Connor, David, "Infant Foreskin Used In Medical Experiments," BAY AREA REPORTER, Thursday, July 8, 1993, p.16.
- 21 Cooperative Approach: Doctor and Client**
1. Personal correspondence on file at UNCIRC headquarters.
  2. Feins, Neil R., "A New Incision for Penile Surgery," JOURNAL OF PEDIATRIC SURGERY, vol. 16, no. 6, December 1981, pp. 817-819.
- 22 Where Do We Go From Here?**
1. Herrera, Alfredo J., M.D., Reply to a letter to the Editor, PEDIATRICS, vol. 71, no. 4, April 1983, pp. 669-670.
  2. Kirya, Christopher, M.B., Ch.B. & Werthmann, Milton W., M.D., FAAP, "Neonatal Circumcision and Penile Dorsal Nerve Block—A Painless Procedure," THE JOURNAL OF PEDIATRICS, vol. 92, no. 6, June 1978, pp. 998-1000.
- Stang, Howard J., M.D., et al., Local Anesthesia for Neonatal Circumcision," JOURNAL OF THE AMERICAN MEDICAL ASSOCIATION, vol. 259, no. 10, March 11, 1988, pp. 1507-1511.
- Howard, Cynthia R., M.D., et al., "Acetaminophen Analgesia in Neonatal Circumcision: The Effect on Pain," PEDIATRICS, vol. 93, no. 4, April 1994, pp. 641-646.
- Ryan, C. Anthony, M.B., MRCPI, FRCPC & Finer, Neil N., M.D., FRCPC, "Changing Attitudes and Practices Regarding Local Analgesia for Newborn Circumcision," PEDIATRICS, vol. 94, no. 2, August 1994, pp. 230-233.
3. Purvis, Kenneth, M.D., Ph.D., THE MALE SEXUAL MACHINE: AN OWNER'S MANUAL, New York, St. Martin's Press, 1992, pp. 27-31.
  4. Williams, George L., M.B., Ch.B., FRACP, "Newborn Circumcision: An Enigma of Health," Second International Childbirth Conference, Sydney, Australia, October 7, 1992.
- Gordon, Andrew & Collin, Jack, "Save the Normal Foreskin," BRITISH MEDICAL JOURNAL, vol. 306, January 2, 1993, pp. 1-2.
- Williams, Nigel, et al., "Why Are Children Referred for Circumcision?," BRITISH MEDICAL JOURNAL, vol. 306, January 2, 1993, p. 28.
- Winn, Denise, "A Campaign to Save the Foreskin," INDEPENDENT, London, Tuesday, April 20, 1993, p. 14.
- Wright, J.E., M.B., B.S., FRACS, FACS, "Further to 'The Further Fate of the Foreskin,'" THE MEDICAL JOURNAL OF AUSTRALIA, vol. 160, February 7, 1994, pp. 134-135.
- Warren, John P., FRCP & Bigelow, Jim, Ph.D., "The Case Against Circumcision," BRITISH JOURNAL OF SEXUAL MEDICINE, vol. 21, no. 5, September/October 1994, pp. 6-8.
5. Wallerstein, Edward, CIRCUMCISION: AN AMERICAN HEALTH FALLACY, New York, Springer Publishing Co., 1980, p. 28.
  6. Chandler, Cameron, "Oregon Retracts Foreskin Coverage," NAPA VALLEY MEN'S NETWORK, vol. 3, no. 3, March 1994, pp. 4 & 7.
  7. Rubin, J.Z., et al., "The Eye of the Beholder: Parents' Views on Sex of Newborns," AMERICAN JOURNAL OF ORTHOPSYCHIATRY, vol. 44, 1974, pp. 512-519.
  8. Block, Jeanne H., "Another Look at Sex Differentiation in the Socialization Behavior of Mothers and Fathers," cited by J. Sherman & F.L. Denmark, eds., PSYCHOLOGY OF WOMEN: FUTURE DIRECTIONS OF RESEARCH, New York, Psychological Dimensions, 1979.
- Block, Jeanne H., "Differential Premises Arising from Differential Socialization of the Sexes: Some Conjectures," CHILD DEVELOPMENT, vol. 54, 1983, pp. 1335-1354.
9. Minuchin, P.P. & Shapiro, E.K., "The School as a Context for Social Development," in P.H. Mussen, ed., HANDBOOK OF CHILD PSYCHOLOGY, vol. 4, New York, John Wiley, 1983.
  10. Britton, Eve, "Violence by Women Targeted," THE MONTEREY COUNTY HERALD, Friday, August 19, 1994, pp. 1A & 16A.
  11. Personal communication with Marilyn Milos, R.N., NOCIRC.
  12. Gounden, S., "The Morbidity Associated with Traditional Circumcisions," SOUTH AFRICAN MEDICAL JOURNAL, vol. 78, no. 12, December 15, 1990, p. 762.
  13. Farrell, Warren, Ph.D., THE MYTH OF MALE POWER, New York, Simon and Schuster, 1993.
  14. Adams, Cecil, *The Straight Dope*, NEW YORK PRESS, February 9-15, 1994.
  15. Milos, Marilyn Fayre, R.N. & Macris, Donna, CNM, MSN, "Circumcision: A Medical or a Human Rights Issue?," JOURNAL OF NURSE-MIDWIFERY, vol. 37, no. 2 (Supplement), March/April 1992, pp. 87S-96S.
  16. Taylor, Laura R., CNM, MSN, Review of "The Joy of Uncircumcising! Restore Your Birthright and Maximize Sexual Pleasure," JOURNAL OF NURSE-MIDWIFERY, vol. 38, no. 6, November/December 1993, p. 363.
  17. Personal correspondence on file at NOCIRC headquarters.
  18. Hammond, Tim, ed., "1993 Statistical Overview of the 'Awakenings' Survey," AWAKENINGS, San Francisco, NOHARMM, 1994, p. 76.
  19. Aldeeb, Sami A., "To Mutilate in the Name of Jehovah or Allah," Third International Symposium on Circumcision, College Park, MD, May 22-25, 1994.
  20. Zavales, Anastasios, Ph.D., "Transcultural, Multireligious, & Interdisciplinary Dimensions of Appropriating Universal Paradigms Regarding the Human Rights Challenge of Genital Mutilation," Third International Symposium on Circumcision, College Park, MD, May 22-25, 1994.
  21. Berkeley, B., cited by Rosemary Romberg in CIRCUMCISION: THE PAINFUL DILEMMA, South Hadley, MA, Bergin & Garvey Publisher, Inc., 1985, p. 112.
  22. Gairdner, Douglas, D.M., MRCP, "The Fate of the Foreskin," BRITISH MEDICAL JOURNAL, vol. 2, December 24, 1949, pp. 1433-1437.
  23. Richards, M.P.M., et al., "Early Behavioral Differences: Gender or Circumcision?," DEVELOPMENTAL PSYCHOBIOLOGY, vol. 9, no. 1, 1976, p. 91.
  24. Brigman, William E., "Circumcision as Child Abuse: The Legal and Constitutional Issues," JOURNAL OF FAMILY LAW, vol. 23, no. 3, 1984-85, pp. 337-357.

---

# References

---

- Abcarian, Robin, "Second—Even Third—Thoughts on Circumcision," LOS ANGELES TIMES, Sunday, January 16, 1994.
- Adams, Cecil, *The Straight Dope*, NEW YORK PRESS, February 9-15, 1994.
- Alcalen, Dr. Erlinda, BILOXI SUN HERALD, cited by Marilyn Milos, R.N., in NOCIRC NEWSLETTER, vol. 2, no. 1, Winter 1987.
- Aldeeb, Sami A., "To Mutilate in the Name of Jehovah or Allah," Third International Symposium on Circumcision, College Park, MD, May 22-25, 1994.
- Alter, Gary J., M.D., et al., "Buried Penis as a Contraindication for Circumcision," JOURNAL OF THE AMERICAN COLLEGE OF SURGEONS, vol. 178, May 1994.
- Altschul, Martin S., M.D., Letter to the Editor, PEDIATRICS, vol. 80, no. 5, November 1987.
- Altschul, Martin S., M.D., "Cultural Bias and The Urinary Tract Infection (UTI) Circumcision Controversy," First International Symposium on Circumcision, Anaheim, CA, March 1-3, 1989.
- Amato, Dante & Garduno-Espinosa, Juan, "Circumcision in the Neonate Male and the Risk of Urinary Tract Infection During the First Year of Life. A Cross Analysis," BOLETIN MEDICO DEL HOSPITAL INFANTIL DE MEXICO, vol. 49, no. 10, October 1992.
- Anders, T.F. & Chalemian, R.J., "The Effect of Circumcision on Sleep-wake States in Human Neonates," PSYCHOSOMATIC MEDICINE, vol. 36, 1974.
- Angell, Dwight E.M., "Infant Foreskins Appear to Aid Healing of Chronic Adult Wounds," DETROIT NEWS AND FREE PRESS, Monday, July 5, 1993.
- Angell, Rich, Letter to the Editor (unpublished), LOS ANGELES TIMES, February 8, 1994.
- Apt, Adolf, "Circumcision and Prostatic Cancer," ACTA MEDICA SCANDINAVICA, vol. 178, fasc. 4, 1965.
- Argenta, Louis C., M.D. & Austad, Eric David, M.D., "Preface: Tissue Expansion," CLINICS IN PLASTIC SURGERY, vol. 14, no. 3, July 1987.
- Arnold, Michael, "Weighty Approach to Reverse Circumcision," THE JERUSALEM REPORT, March 25, 1993.
- Austad, Eric David, M.D., "The Origin of Expanded Tissue," CLINICS IN PLASTIC SURGERY, vol. 14, no. 3, July 1987.
- Baldwin, James, GOING TO MEET THE MAN, New York, Dial Press, 1965.
- Beaugé, Michel, M.D., TRAITEMENT MÉDICAL DU PHIMOSIS CONGENITAL DE L'ADOLESCENT. [CONSERVATIVE TREATMENT OF PRIMARY PHIMOSIS IN ADOLESCENTS, trans. John P. Warren, FRCP], Thesis for the University Diploma of Andrology, Saint-Antoine University, Paris VI, 1990-1991.
- Bergeson, Paul S., M.D., et al., "The Inconspicuous Penis," PEDIATRICS, vol. 92, no. 6, December 1993.
- Berkeley, B., FORESKIN, private publication, 1983.
- Berkeley, B., cited by Rosemary Romberg in CIRCUMCISION: THE PAINFUL DILEMMA, South Hadley, MA, Bergin & Garvey Publisher, Inc., 1985.
- Bigelow, Jim, Ph.D., "Circumcision and Twentieth-Century Christianity," Second International Symposium on Circumcision, San Francisco, April 30 - May 3, 1991.
- Bigelow, Jim, Ph.D., "Uncircumcising: Undoing the Effects of an Ancient Practice in a Modern World," MOTHERING, no. 71, Summer 1994.
- Blackmon, Edward B., Jr., M.D., "A Look at Medical Reasons for Circumcision Controversy," THE BEACON JOURNAL, Akron, OH, Sunday, May 29, 1988.
- Block, Jeanne H., "Another Look at Sex Differentiation in the Socialization Behavior of Mothers and Fathers," cited by J. Sherman & F.L. Denmark, eds., PSYCHOLOGY OF WOMEN: FUTURE DIRECTIONS OF RESEARCH, New York, Psychological Dimensions, 1979.
- Block, Jeanne H., "Differential Premises Arising from Differential Socialization of the Sexes: Some Conjectures," CHILD DEVELOPMENT, vol. 54, 1983.
- Boyd, Billy Ray, CIRCUMCISION: WHAT IT DOES, San Francisco, Taterhill Press, 1990.
- Brazelton, T. Berry, M.D., DOCTOR AND CHILD, New York, Delacourte Press/Seymour Lawrence, 1970.
- Briggs, Anne, CIRCUMCISION: WHAT EVERY PARENT SHOULD KNOW, Earlysville, VA, Birth and Parenting Publications, Inc., 1985.
- Brigman, William E., "Circumcision as Child Abuse: The Legal and Constitutional Issues," JOURNAL OF FAMILY LAW, vol. 23, no. 3, 1984-85.
- Britton, Eve, "Violence by Women Targeted," THE MONTEREY COUNTY HERALD, Friday, August 19, 1994.
- Bryk, Felix, CIRCUMCISION IN MAN AND WOMAN, New York, American Ethnological Press, 1934.
- Bryk, Felix, SEX & CIRCUMCISION, North Hollywood, CA, Brandon House, 1967.
- BUFF Statistics, March 1991, on file at NOCIRC headquarters.
- Chandler, Cameron, "Oregon Retracts Foreskin Coverage," NAPA VALLEY MEN'S NETWORK, vol. 3, no. 3, March 1994.
- Chessare, John B., M.D., MPH, "Circumcision: Is the Risk of Urinary Tract Infection Really the Pivotal Issue?," CLINICAL PEDIATRICS, vol. 31, no. 2, February 1992.
- "Circumcision, A Guide to the Methods to be Employed by Mohalim," New York: Department of Health, City of New York, cited by Edward Wallerstein in CIRCUMCISION: AN AMERICAN HEALTH FALLACY, New York, Springer Publishing Co., 1980.
- Clark, K.B. & Clark, M.P., "Racial Identification and Preference in Negro Children," cited by T.M. Newcomb & E.L. Hartely, eds., in READINGS IN SOCIAL PSYCHOLOGY, New York, Holt, 1947.
- Cohen, Arthur R., ATTITUDE CHANGE AND SOCIAL INFLUENCE, New York, Basic Books, Inc., 1964.
- Cohen, Herman A., M.D., et al., "Postcircumcision Urinary Tract Infection," CLINICAL PEDIATRICS, vol. 31, no. 6, June 1992.
- Cohen, Mimis & Marschall, Michael, "Tissue Expansion: An Alternative Technique in Reconstructive Surgery," 1990 SURGICAL ANNUAL, Chicago, University of Illinois College of Medicine, vol. 22.
- Condry, J. & Condry, S., "Sex Differences: A Study of the Eye of the Beholder," CHILD DEVELOPMENT, vol. 47, 1976.
- "Conference on Infants Studies: The First Experience of Life," NEW YORK TIMES, March 14, 1978.
- Cook, Linda S., M.S., et al., "Circumcision and Sexually Transmitted Diseases," AMERICAN JOURNAL OF PUBLIC HEALTH, vol. 84, no. 2, February 1994.
- Cromie, William J., M.D., MBA & Kelleher, Ruth E., R.N., BSN, "Circumcision," JOURNAL OF THE AMERICAN MEDICAL ASSOCIATION, vol. 269, no. 4, January 27, 1993.
- Cuckow, Peter M., et al., "Preputial Plasty: A Good Alternative to Circumcision," JOURNAL OF PEDIATRIC SURGERY, vol. 29, no. 4, April 1994.
- Curran, James, M.D., Personal correspondence, cited by Marilyn Milos, R.N., in NOCIRC NEWSLETTER, vol. 2, no. 1, Winter 1987.
- DeMeo, James, Ph.D., "Desertification and the Origins of Armoring: The Saharasan Connection, Part V," JOURNAL OF ORGONOMY, vol. 24, no. 1, 1990.
- Denniston, George C., M.D., MPH, "First, Do No Harm," First International Symposium on Circumcision, Anaheim, CA, March 1-3, 1989.
- Denton, John, M.D., et al., "Circumcision Complication," CLINICAL PEDIATRICS, vol. 17, no. 3, March 1978.
- Deutsch, Morton & Krauss, Robert M., THEORIES IN SOCIAL PSYCHOLOGY, New York, Basic Books, Inc., 1965.
- Eason, Julian D., et al., "Male Ritual Circumcision Resulting in Acute Renal Failure," BRITISH MEDICAL JOURNAL, vol. 309, September 10, 1994.
- Edell, Dean, M.D., cited by Thomas J. Ritter, M.D., in SAY NO TO CIRCUMCISION!, Aptos, CA, Hourglass Book Publishing, 1992.
- Edwardes, Allen, EROTICA JUDAICA, New York, The Julian Press, Inc., 1967.
- Eiger, Marvin S., M.D., "The Case for Circumcision," TODAY'S HEALTH, vol. 50, no. 4, April 1972.
- Emde, R.N., et al., "Stress and Neonatal Sleep," PSYCHOSOMATIC MEDICINE, vol. 33, 1971.
- Emmett, Anthony J.J., "Z-plasty Reconstruction for Preputial Stenosis—A Surgical Alternative to Circumcision," AUSTRALIAN PAEDIATRIC JOURNAL, vol. 18, 1982.
- ENCYCLOPEDIA OF ASSOCIATIONS, 19th ed., 1985.
- Erickson, John A., MAKING AMERICA SAFE FOR FORESKINS, private publication, 1989.
- Farrell, Warren, Ph.D., THE MYTH OF MALE POWER, New York, Simon and Schuster, 1993.
- Feins, Neil R., "A New Incision for Penile Surgery," JOURNAL OF PEDIATRIC SURGERY, vol. 16, no. 6, December 1981.
- Feriz, H., "Eine einfache Methode zur Plastik des Präputiums nach radikaler (ritueller) Zirkumzision," ["A Simple Method for Preputial Plastic Replacement After Radical (Ritual) Circumcision," trans. Tim Sally & Bernd Vey], MÜNCHENER MEDIZINISCHE WOCHENSCHRIFT, vol. 31, August 3, 1962.
- Festinger, Leon, "The Psychological Effects of Insufficient Reward," AMERICAN PSYCHOLOGIST, vol. 16, 1961.
- Fink, Aaron J., M.D., "In Defense of Circumcision," cited by Edward Wallerstein in CIRCUMCISION: INFORMATION, MISINFORMATION, DISINFORMATION, San Anselmo, CA, NOCIRC, 1986.
- Fink, Aaron J., M.D., CIRCUMCISION: A PARENT'S DECISION FOR LIFE, Mountain View, CA, Kavanah Publishing Co., 1988.
- Fink, Aaron J., M.D., "Circumcision and Sand," JOURNAL OF THE ROYAL SOCIETY OF MEDICINE, vol. 84, November 1991.
- Fleiss, Paul M., M.D., MPH, Letter to the Editor, TRUTH SEEKER, vol. 1, no. 3, July/August 1989.
- Frاند, M., et al., Letter to the Editor, PEDIATRICS, vol. 54, no. 4, October 1974.
- Freedman, Lawrence D., M.D., Letter to the Editor, JOURNAL OF THE AMERICAN MEDICAL ASSOCIATION, vol. 214, no. 12, December 21, 1970.

- Gardner, Douglas, D.M., MRCP, "The Fate of the Foreskin," BRITISH MEDICAL JOURNAL, vol. 2, December 24, 1949.
- Ganiats, Theodore G., M.D., et al., "Routine Neonatal Circumcision: A Cost-Utility Analysis," MEDICAL DECISION MAKING, vol. 11, no. 4, October/December 1991.
- Gardner, A.M.N., "Circumcision and Sand," JOURNAL OF THE ROYAL SOCIETY OF MEDICINE, vol. 84, June 1991.
- Gayman, Dan, LO, CHILDREN... OUR HERITAGE FROM GOD, Schell City, MO, Church of Israel, 1991.
- Gelbaum, Ilene, CNM, "Male Newborn Circumcision: The Nurse-Midwifery Model," 35th Annual Meeting of the American College of Nurse-Midwives (ACNM), Atlanta, GA, May 13-14, 1990.
- Gelbaum, Ilene, CNM, "Circumcision: Refining a Traditional Surgical Technique," JOURNAL OF NURSE-MIDWIFERY, vol. 38, no. 2 (Supplement), March/April 1993.
- Gellis, Sydney S., M.D., "Circumcision," AMERICAN JOURNAL OF DISEASES OF CHILDHOOD, vol. 132, no. 12, December 1978.
- Gentile, Dr. Anthony, PITTSBURGH POST GAZETTE, cited by Marilyn Milos, R.N., in NOCIRC NEWSLETTER, vol. 2, no. 1, Winter 1987.
- Gershman, Dr. Martin, LOS ANGELES TIMES, cited by Marilyn Milos, R.N., in NOCIRC NEWSLETTER, vol. 2, no. 1, Winter 1987.
- Gilbaugh, James H., Jr., M.D., *ask 'Dr. Private Parts,'* MEN'S HEALTH, vol. 6, no. 3, March 1990.
- Gilbaugh, James H., Jr., M.D., *ask 'Dr. Private Parts,'* MEN'S HEALTH, vol. 6, no. 11, November 1990.
- Gilbaugh, James H., Jr., M.D., *ask 'Dr. Private Parts,'* MEN'S HEALTH, vol. 6, no. 12, December 1990.
- Gilbaugh, James H., Jr., M.D., *ask 'Dr. Private Parts,'* MEN'S HEALTH, vol. 7, no. 5, May 1991.
- Gilbaugh, James H., Jr., M.D., *ask 'Dr. Private Parts,'* MEN'S HEALTH, vol. 7, no. 9, September 1991.
- Goldman, Ronald F., "Circumcision: New Information Raises Questions," JEWISH NEWS, September 1990, and "Is Circumcision Advisable?," THE JEWISH TIMES, March 21, 1991.
- Goncalves, Fernando, "Abused Kids Become Abusive Managers, Study Says," THE CONTRA COSTA TIMES, Monday, October 1, 1990.
- Goodman, Terri, R.N., et al., "Tissue Expansion: A New Modality in Reconstructive Surgery," AORN JOURNAL, vol. 46, no. 2, August 1987.
- Goodwin, W.E. & Thelan, H.M., "Plastic Reconstruction of Penile Skin: Implantation of the Penis into the Scrotum," JOURNAL AMERICAN MEDICAL ASSOCIATION, vol. 144, 1950.
- Goodwin, W.E. & Scott, W.W., "Phalloplasty," THE JOURNAL OF UROLOGY, vol. 68, 1952.
- Goodwin, Willard E., "Uncircumcision: A Technique for Plastic Reconstruction of a Prepuce After Circumcision," THE JOURNAL OF UROLOGY, vol. 144, November 1990.
- Gordon, Andrew & Collin, Jack, "Save the Normal Foreskin," BRITISH MEDICAL JOURNAL, vol. 306, January 2, 1993.
- Gounden, S., "The Morbidity Associated with Traditional Circumcisions," SOUTH AFRICAN MEDICAL JOURNAL, vol. 78, no. 12, December 15, 1990.
- Grace, Beth, "Ohio Doctor Charged with Immorality," MESA TRIBUNE/TEMPER DAILY/CHANDLER ARIZONAN TRIBUNE, Friday, December 9, 1988.
- Greer, Donald M., Jr., M.D. & Mohl, Paul C., M.D., "Foreskin Reconstruction: A Preliminary Report," SEXUAL MEDICINE TODAY, April 1982.
- Greer, Donald M., Jr., M.D., et al., "A Technique for Foreskin Reconstruction and Some Preliminary Results," THE JOURNAL OF SEX RESEARCH, vol. 18, no. 4, November 1982.
- Greer, Donald M., M.D., Review of: "The Joy of Uncircumcising! Restore Your Birthright and Maximize Sexual Pleasure," PLASTIC AND RECONSTRUCTIVE SURGERY, vol. 90, no. 6, December 1992.
- Griffiths, D., M.A., FRCS & Frank, J.D., FRCS, "Inappropriate Circumcision Referrals by GPs," JOURNAL OF THE ROYAL SOCIETY OF MEDICINE, vol. 85, June 1992.
- Grimes, David A., M.D., "Routine Circumcision of the Newborn Infant: A Reappraisal," AMERICAN JOURNAL OF OBSTETRICS AND GYNECOLOGY, vol. 130, no. 2, January 1978.
- Grossman, Elliot, M.D. & Posner, Norman Ames, M.D., "Surgical Circumcision of Neonates: A History of Its Development," OBSTETRICS AND GYNECOLOGY, vol. 58, no. 2, August 1981.
- Grossman, Elliot A., M.D., CIRCUMCISION: A Pictorial Atlas of its History, Instrument Development and Operative Techniques, Great Neck, NY, Todd & Honeywell, Inc., 1982.
- Hall, Robert G., "Epispasm: Circumcision in Reverse," BIBLE REVIEW, August 1992.
- Hammond, Tim, ed., "1992 'Journeymen' Body Image Survey," AWAKENINGS, San Francisco, NOHARM, 1994.
- Hammond, Tim, ed., "1993 Statistical Overview of the 'Awakenings' Survey," AWAKENINGS, San Francisco, NOHARM, 1994.
- Hand, Eugene A., M.D., "History of Circumcision," JOURNAL OF MICHIGAN STATE MEDICAL SOCIETY, vol. 49, no. 5, May 1950.
- Herrera, Alfredo J., M.D., Reply to a letter to the Editor, PEDIATRICS, vol. 71, no. 4, April 1983.
- Hoffman, S., et al., "A New Operation for Phimosis: Prepuce-saving Technique with Multiple Y-V-plasties," BRITISH JOURNAL OF UROLOGY, vol. 56, 1984.
- Hoppe, Art, "Penile Enhancement," SAN FRANCISCO CHRONICLE, Sunday Punch, Sunday, October 3, 1993.
- Hosken, Fran P., "Genital and Sexual Mutilation of Females," WOMEN'S INTERNATIONAL NETWORK NEWS, Lexington, MA.
- Howard, Cynthia R., M.D., et al., "Acetaminophen Analgesia in Neonatal Circumcision: The Effect on Pain," PEDIATRICS, vol. 93, no. 4, April 1994.
- Illingworth, Ronald S., M.D., THE NORMAL CHILD, 8th ed., New York, Churchill Livingstone, 1983.
- Isaac, Erich, "The Enigma of Circumcision," COMMENTARY, vol. 43, no. 1, January 1967.
- Isenberg, Seymour & Elting, L.M., CONSUMER'S GUIDE TO SUCCESSFUL SURGERY, cited by Edward Wallerstein in CIRCUMCISION: AN AMERICAN HEALTH FALLACY, New York, Springer Publishing Co., 1980.
- Jacobs, A.J., "The First Cut," M MAGAZINE, vol. 9, no. 12, September 1992.
- Jacobson, B., et al., "Perinatal Origin of Adult Self-destructive Behavior," ATCA PSYCHAIR. SCAND., vol. 76, 1987.
- James, Theodore, M.B., Ch.B., "Philo on Circumcision," SOUTH AFRICA MEDIESE TYDSKRIF, vol. 50, no. 36, 21 Augustus 1976.
- James, William, M.D., cited in "Circumcision: Is it a Health Benefit?," CONSUMER REPORTS: HEALTH LETTER, vol. 1, no. 4, December 1989.
- Joseph, Max, "Circumcision," THE UNIVERSAL JEWISH ENCYCLOPEDIA, New York, The Universal Jewish Encyclopedia, Inc., 1941.
- "The Joy of Uncircumcising! Restore Your Birthright and Maximize Sexual Pleasure," Review by BRITISH JOURNAL OF UROLOGY, vol. 73, 1994.
- Kaplan, George W., "Circumcision—An Overview," CURRENT PROBLEMS IN PEDIATRICS, vol. 7, no. 5, March 1977.
- Katchandourian, Herant A. & Lunde, Donald T., FUNDAMENTALS OF HUMAN SEXUALITY, 2nd ed., New York, Holt, Rinehart & Winston, 1972.
- Kelley, Dr. Charles, ALLENTOWN MORNING CALL, cited by Marilyn Milos, R.N., in NOCIRC NEWSLETTER, vol. 2, no. 1, Winter 1987.
- Kikiros, C.S., et al., "The Response of Phimosis to Local Steroid Application," PEDIATRIC SURGERY INTERNATIONAL, vol. 8, 1993.
- King, Lowell, M.D., et al., "Circumcision: Rite, Rational, or Both?," PATIENT CARE, March 15, 1978.
- Kirby, Roger S., Review of "The Joy of Uncircumcising! Restore Your Birthright and Maximize Sexual Pleasure," BRITISH MEDICAL JOURNAL, vol. 309, September 10, 1994.
- Kirya, Christopher, M.B., Ch.B. & Werthmann, Milton W., Jr., M.D., FAAP, "Neonatal Circumcision and Penile Dorsal Nerve Block—A Painless Procedure," THE JOURNAL OF PEDIATRICS, vol. 92, no. 6, June 1978.
- Kistler, S.L., M.D., "Rapid Bloodless Circumcision of Male and Female and Its Technic," JOURNAL OF AMERICAN MEDICAL ASSOCIATION, vol. 54, no. 22, May 28, 1910.
- Knight, J.F., B.A., M.B., B.S., FRACP, "Urinary Tract Infection," CURRENT OPINION IN PEDIATRICS, vol. 3, 1991.
- Kohler, Kaufmann, Ph.D., "Circumcision," THE JEWISH ENCYCLOPEDIA, New York, KTAV Publishing House, Inc., 1964.
- Kunin, Samuel A., "Base Circumcision Decision on What's Best," LOS ANGELES TIMES, Sunday, January 30, 1994.
- Lafferty, P.M., et al., "Management of Foreskin Problems," ARCHIVES OF DISEASE IN CHILDHOOD, vol. 66, 1991.
- Landers, Ann, "Doctor Adds Women's Concerns to List of Circumcision Benefits," CONTRA COSTA TIMES, Monday, April 12, 1993.
- Lattimer, John K., M.D., D.Sc. & Stalneck, Michael C., M.D., "Tissue Expansion of Underdeveloped Scrotum to Accommodate Large Testicular Prosthesis," UROLOGY, vol. 33, no. 1, January 1989.
- Lawler, Frank H., M.D., et al., "Circumcision: A Decision Analysis of Its Medical Value," FAMILY MEDICINE, vol. 23, no. 8, November/December 1991.
- Levin, S., M.B., MRCP, DCH, "Brit Milah: Ritual Circumcision," SOUTH AFRICAN MEDICAL JOURNAL, vol. 39, December 11, 1965.
- Levitt, Selwyn B., M.D., et al., "Iatrogenic Microphallus Secondary to Circumcision," UROLOGY, vol. 8, no. 5, November 1976.
- Lewis, Alfred Allan, et al., THE MALE: HIS BODY, HIS SEX, Garden City, NY, Anchor Press/Doubleday, 1978.



- Lightfoot-Klein, Hanny, *PRISONERS OF RITUAL: AN ODYSSEY INTO FEMALE GENITAL CIRCUMCISION IN AFRICA*, New York, Harrington Park Press, 1989.
- Lilienfeld, Abraham M., M.D., MPH & Graham, Saxon, Ph.D., "Validity of Determining Circumcision Status by Questionnaire as Related to Epidemiological Studies of Cancer of the Cervix," *JOURNAL OF THE NATIONAL CANCER INSTITUTE*, vol. 21, no. 4, October 1958.
- "Love Surgery" Victim Awarded \$5 million," news release, Dayton, Ohio, June 22, 1991.
- Lynch, M.J. & Pryor, J.P., "Uncircumcision: A One-stage Procedure," *BRITISH JOURNAL OF UROLOGY*, vol. 72, no. 2, August 1993.
- Maden, Christopher, Ph.D., et al., "History of Circumcision, Medical Conditions, and Sexual Activity and Risk of Penile Cancer," *JOURNAL OF THE NATIONAL CANCER INSTITUTE*, vol. 85, no. 1, January 6, 1993.
- Maimonides, Moses, *THE GUIDE FOR THE PERPLEXED*, New York, Dover Publications, Inc., 1956.
- Male Box*, *MEN'S CONFIDENTIAL*, December 1993.
- Marchbanks, Howard, M.D., Interview, cited by Rosemary Romberg in *CIRCUMCISION: THE PAINFUL DILEMMA*, South Hadley, MA, Bergin & Garvey Publisher, Inc., 1985.
- Marcus, Jeffrey, MPH, et al., "Tissue Expansion: Past, Present, and Future," *JOURNAL OF THE AMERICAN ACADEMY OF DERMATOLOGY*, vol. 23, no. 5, pt. 1, November 1990.
- Marino, Leonard J., M.D., Letter to the Editor, *CONTEMPORARY PEDIATRICS*, November 1989.
- Masters, William H. & Johnson, Virginia E., *HUMAN SEXUAL RESPONSE*, Boston, Little, Brown and Co., 1966.
- Matturri, L., M.D., et al., "Long-Term Histopathologic Evaluation of Human Expanded Skin," *PLASTIC AND RECONSTRUCTIVE SURGERY*, vol. 90, no. 4, October 1992.
- McDonald, C.F., M.D., "Circumcision of the Female," *GP*, vol. 18, no. 3, September 1958.
- McKay, R.J., "The Newborn Infant," *TEXTBOOK OF PEDIATRICS*, 9th ed., W.E. Nelson, ed., Philadelphia, W.B. Saunders Co., 1969.
- McMillen, S.I., M.D., *NONE OF THESE DISEASES*, Westwood, NJ, Fleming H. Revell Co., 1963.
- McMillen, S.I., M.D., *NONE OF THESE DISEASES*, 2nd ed., Old Tappan, NJ, Fleming H. Revell Co., 1984.
- Meeres, Edward E., M.D., Letter to the Editor, *THE LANCET*, November 30, 1889.
- Mercier, O.F., "Restauration d'un Prépuce," ["Restauration of a Prepuce Removed by Circumcision," trans. Frederick Hodges], *L'UNION MÉDICALE DU CANADA*, vol. 3, no. 4, April 1898.
- Milos, Marilyn Fayre, R.N. & Macris, Donna, CNM, MSN, "Circumcision: A Medical or a Human Rights Issue?," *JOURNAL OF NURSE-MIDWIFERY*, vol. 37, no. 2 (Supplement), March/April 1992.
- Minuchin, P.P. & Shapiro, E.K., "The School as a Context for Social Development," in P.H. Mussen, ed., *HANDBOOK OF CHILD PSYCHOLOGY*, vol. 4, New York, John Wiley, 1983.
- Mohl, Paul C., M.D., et al., "Prepuce Restoration Seekers: Psychiatric Aspects," *ARCHIVES OF SEXUAL BEHAVIOR*, vol. 10, no. 4, 1981.
- Money, John, Ph.D. & Tucker, Patricia, *SEXUAL SIGNATURES*, Boston, Little, Brown and Co., 1975.
- Money, John, Ph.D., "Sexology, Body Image, Foreskin Restoration, and Bisexual Status," *THE JOURNAL OF SEX RESEARCH*, vol. 28, no. 1, February 1991.
- Morgan, David Z., M.D., "Airborne Babies," cited in *A Chuckle a Day Keeps the Doctor Happy*, *AMERICAN MEDICAL NEWS*, April 22/29, 1991.
- Moss, C.L., "The Unkindest Cut," *SAN FRANCISCO EXAMINER, Image*, Sunday, December 15, 1991.
- Moss, Lisa Braver, B.A., "The Jewish Roots of Anti-Circumcision Arguments," Second International Symposium on Circumcision, San Francisco, April 30 - May 3, 1991.
- Neifert, Marianne, M.D., *DR. MOM*, New York, Signet Book, 1986.
- Newton, Lancelot, Letter to the Editor, *THE LANCET*, October 26, 1889.
- Noble, Elizabeth, P.T., "Psychological Motivation of Choosing Not to Circumcise," Second International Symposium on Circumcision, San Francisco, April 30 - May 3, 1991.
- Noble, Elizabeth, P.T., Letter to the Editor, *AMERICAN MEDICAL NEWS*, August 5, 1991.
- O'Connor, David, "Infant Foreskin Used In Medical Experiments," *BAY AREA REPORTER*, Thursday, July 8, 1993.
- Ohjimi, Toshihide, M.D. & Ohjimi, Hiroyuki, M.D., "Special Surgical Techniques for Relief of Phimosis," *THE JOURNAL OF DERMATOLOGIC SURGERY AND ONCOLOGY*, vol. 7, no. 4, April 1981.
- Olenius, Michael, M.D., et al., "Mitotic Activity in Expanded Human Skin," *PLASTIC AND RECONSTRUCTIVE SURGERY*, vol. 91, no. 2, February 1993.
- "Olympic Circumstraint," Brochure, Olympic Medical Corp., Seattle, WA.
- Øster, Jakob, M.D., "Further Fate of the Foreskin," *ARCHIVES OF DISEASE IN CHILDHOOD*, vol. 43, no. 228, April 1968.
- Øster, Jakob, M.D., "Clinical Phenomena Noted by a School Physician Dealing with Healthy Children," *CLINICAL PEDIATRICS*, vol. 15, no. 8, August 1976.
- Ostwald, Peter F. & Peltzman, Philip, "The Cry of the Human Infant," *SCIENTIFIC AMERICAN*, vol. 230, no. 3, March 1974.
- Paige, Karen Erickson, "The Ritual of Circumcision," *HUMAN NATURE*, May 1978.
- Panati, Charles, *PANATI'S EXTRAORDINARY ENDINGS OF PRACTICALLY EVERYTHING AND EVERYBODY*, New York, Harper & Row, Publishers, 1989.
- Parkash, Satya, "Phimosis and Its Plastic Correction," *JOURNAL OF THE INDIAN MEDICAL ASSOCIATION*, vol. 58, no. 10, May 16, 1972.
- Pasyk, Krystyna A., M.D., Ph.D., et al., "Quantitative Analysis of the Thickness of Human Skin and Subcutaneous Tissue Following Controlled Expansion with a Silicone Implant," *PLASTIC AND RECONSTRUCTIVE SURGERY*, vol. 81, no. 4, April 1988.
- Penn, Jack, FRCS, "Penile Reform," *BRITISH JOURNAL OF PLASTIC SURGERY*, vol. 16, 1963.
- Pollack, Miriam, "Circumcision: A Jewish Feminist Perspective," Third International Symposium on Circumcision, College Park, MD, May 22-25, 1994.
- Pomeranz, Virginia E., M.D. & Schultz, Dodi, *THE MOTHERS' MEDICAL ENCYCLOPEDIA*, New York, Signet Book, 1972.
- Porter, J., *BLACK CHILD, WHITE CHILD: THE DEVELOPMENT OF RACIAL ATTITUDES*, Cambridge, MA, Harvard University Press, 1971.
- Preston, E. Noel, Captain, M.C., USAF, "Whither the Foreskin?," *JOURNAL OF THE AMERICAN MEDICAL ASSOCIATION*, vol. 213, no. 11, September 14, 1970.
- Purvis, Kenneth, M.D., Ph.D., *THE MALE SEXUAL MACHINE: AN OWNER'S MANUAL*, New York, St. Martin's Press, 1992.
- Rathmann, W.G., M.D., "Female Circumcision, Indications and a New Technique," *GP*, vol. 20, no. 3, September 1959.
- "Rating the Circumcisers," *NEWSWEEK*, vol. 80, no. 10, September 4, 1972.
- Ravich, Abraham, M.D., *PREVENTING V.D. AND CANCER BY CIRCUMCISION*, New York, Philosophical Library, 1973.
- Reichelderfer, Thomas E., M.D. & Fraga, Juan R., M.D., "Circumcision," cited by Kenneth S. Shepard, M.D., *FAAP*, in *CARE OF THE WELL BABY*, 2nd ed., J.B. Lippencott Co., 1968.
- Reinisch, June, Ph.D., Interview, *Real Personal*, CNBC, April 14, 1994.
- Remondino, P.C., M.D., *HISTORY OF CIRCUMCISION*, New York, The F.A. Davis Co., Publishers, 1900.
- Reuben, David, M.D., *EVERYTHING YOU EVER WANTED TO KNOW ABOUT SEX*, New York, David McKay Co., Inc., 1969.
- Reuben, David, M.D., *HOW TO GET MORE OUT OF SEX*, New York, Bantam Books, 1975.
- Richards, M.P.M., et al., "Early Behavioral Differences: Gender or Circumcision?," *DEVELOPMENTAL PSYCHOBIOLOGY*, vol. 9, no. 1, 1976.
- Ritter, Thomas J., M.D., *SAY NO TO CIRCUMCISION!*, Aptos, CA, Hourglass Book Publishing, 1992.
- Robertson, Pat, Reprint of personal correspondence on file at UNCIRC headquarters.
- Rogers, Peggy & Wallace, Richard, "Infant Bleeds to Death After Being Circumcised," *THE MIAMI HERALD*, Saturday, June 26, 1993.
- Romberg, Henry C., M.D., *BRIS MILAH*, New York, Feldheim Publishers, 1982.
- Romberg, Rosemary, *CIRCUMCISION: THE PAINFUL DILEMMA*, South Hadley, MA, Bergin & Garvey Publisher, Inc., 1985.
- Romberg, Rosemary, Personal correspondence, cited by Billy Ray Boyd in *CIRCUMCISION: WHAT IT DOES*, San Francisco, Taterhill Press, 1990.
- Rothenberg, Moshe, CSW, "Ending Circumcision in the Jewish Community?," Second International Symposium on Circumcision, San Francisco, April 30 - May 3, 1991.
- Rothenberg, Moshe, CSW, "Jewish Roots of Circumcision," Third International Symposium on Circumcision, College Park, MD, May 22-25, 1994.
- Rubin, J.Z., et al., "The Eye of the Beholder: Parents' Views on Sex of Newborns," *AMERICAN JOURNAL OF ORTHOPSYCHIATRY*, vol. 44, 1974.
- Rubin, Jody P., M.A., "Celsus' Decircumcision Operation," *UROLOGY*, vol. 16, no. 1, July 1980.
- Rutherford, Frederick W., M.D., *YOU AND YOUR BABY*, New York, Signet Book, 1971.
- Ryan, C. Anthony, M.B., MRCP, FRCP & Finer, Neil N., M.D., FRCP, "Changing Attitudes and Practices Regarding Local Analgesia for Newborn Circumcision," *PEDIATRICS*, vol. 94, no. 2, August 1994.
- Sathaye, U.V., et al., "Skin Bridge—A Complication of Paediatric Circumcision," *BRITISH JOURNAL OF UROLOGY*, vol. 66, no. 2, 1990.
- Schlosberg, Charles, M.D., "Thirty Years of Ritual Circumcisions," *CLINICAL PEDIATRICS*, vol. 10, no. 4, April 1971.
- Schlossberger, Norman M., M.D., MPH, et al., "Early Adolescent Knowledge and Attitudes About Circumcision: Methods and Implications for Research," *JOURNAL OF ADOLESCENT HEALTH*, vol. 13, no. 4, June 1992.

- Schneider, T., M.D., FRCP, "Circumcision and 'Uncircumcision,'" *SOUTH AFRICAN MEDICAL JOURNAL*, March 27, 1976.
- Schoen, Edgar J., Letter to the Editor, *JOURNAL OF UROLOGY*, vol. 146, no. 6, December 1991.
- Schultz, Terri, "Female Circumcision: Operation Orgasm," *VIVA*, vol. 2, no. 6, March 1975.
- Seabrook, Charles, "Lawyers: \$22.8 million to be Paid Over Botched Circumcision," *THE ATLANTA CONSTITUTION*, Tuesday, March 12, 1991.
- "Should Your Child Be Circumcised?," *FAMILY HEALTH*, cited by Anne Briggs in *CIRCUMCISION: WHAT EVERY PARENT SHOULD KNOW*, Earlsyville, VA, Birth and Parenting Publications, Inc., 1985.
- Silber, Sherman J., M.D., *THE MALE*, New York, Charles Scribner's Sons, 1981.
- Silberner, Joanne & Carey, Joseph, "Circumcision," *U.S. NEWS & WORLD REPORT*, May 30, 1988.
- Simonsen, J. Neil, M.D., et al., "Human Immunodeficiency Virus Infection Among Men with Sexually Transmitted Diseases," *THE NEW ENGLAND JOURNAL OF MEDICINE*, vol. 319, no. 5, August 4, 1988.
- "Skin Deep," *DISCOVER*, August 1991.
- Snowman, L. V., "The Surgery of Ritual Circumcision," 3rd ed., cited by Edward Wallerstein in *CIRCUMCISION: AN AMERICAN HEALTH FALLACY*, New York, Springer Publishing Co., 1980.
- Snyder, Howard M., III, "To Circumcise or Not," *HOSPITAL PRACTICE*, January 15, 1991.
- Snyder, James L., M.D., FACS, Presentation to the California Medical Association Scientific and Educational Activities Committee, 118th Annual Session and Western Scientific Assembly, Anaheim, CA, March 4, 1989.
- Spach, David H., M.D., et al., "Lack of Circumcision Increases the Risk of Urinary Tract Infection in Young Men," *JOURNAL OF THE AMERICAN MEDICAL ASSOCIATION*, vol. 267, no. 5, February 5, 1992.
- Speert, Harold, M.D., "Circumcision of the Newborn," *OBSTETRICS AND GYNECOLOGY*, vol. 2, no. 2, August 1953.
- Spence, Sir James, cited by Ronald S. Illingworth, M.D., in *THE NORMAL CHILD*, 8th ed., New York, Churchill Livingstone, 1983.
- Spencer, Walter G., Letter to the Editor, *THE LANCET*, November 2, 1889.
- Spitz, René A., M.D., "Authority and Masturbation: Some Remarks on a Bibliographical Investigation," cited by Irwin M. Marcus, M.D. & John J. Francis, M.D., in *MASTURBATION: FROM INFANCY TO SENESCENCE*, New York, International Universities Press, Inc., 1975.
- Spock, Benjamin, M.D., *BABY AND CHILD CARE*, New York, Pocket Books, 1946.
- Spock, Benjamin, M.D., "Circumcision—It's Not Necessary," *REDBOOK*, April 1989.
- Spratling, Edgar J., M.D., "Masturbation in the Adult," *MEDICAL RECORD*, vol. 48, no. 13, September 28, 1895.
- Stang, Howard J., M.D., et al., "Local Anesthesia for Neonatal Circumcision," *JOURNAL OF THE AMERICAN MEDICAL ASSOCIATION*, vol. 259, no. 10, March 11, 1988.
- Stein, Martin T., et al., "Routine Neonatal Circumcision: The Gap Between Contemporary Policy and Practice," *THE JOURNAL OF FAMILY PRACTICE*, vol. 15, no. 1, July 1982.
- Stemer, Rosalie, "Jewish Refugees' Rite of Passage," *SAN FRANCISCO CHRONICLE, Sunday Punch*, Sunday, December 27, 1992.
- Still, Eugene F., II, M.D. & Goodman, R. Cole, M.D., "Total Reconstruction of a Two-Compartment Scrotum by Tissue Expansion," *PLASTIC AND RECONSTRUCTIVE SURGERY*, vol. 85, no. 5, May 1990.
- Stoddard, Kathy, "Circumcision," *AMERICAN BABY*, March 1991.
- Strand, John, Personal correspondence, cited by Rosemary Romberg in *CIRCUMCISION: THE PAINFUL DILEMMA*, South Hadley, MA, Bergin & Garvey Publisher, Inc., 1985.
- Streitfeld, Hank, M.D., "Should Circumcision Be Routine?," *PARENTS' MAGAZINE*, March 5, 1981.
- Swadey, John, M.D., Personal correspondence, cited by Marilyn Milos, R.N., in *NOCIRC NEWSLETTER*, vol. 2, no. 1, Winter 1987.
- Taguchi, Yosh, M.D., *PRIVATE PARTS*, New York, Doubleday, 1988.
- Taylor, John, M.B., FRCP, "The Prepuce: What, Exactly, is Removed by Circumcision?," Second International Symposium on Circumcision, San Francisco, April 30 - May 3, 1991.
- Taylor, John, M.B., FRCP, "The Prepuce Defined," Third International Symposium on Circumcision, College Park, MD, May 22-25, 1994.
- Taylor, Laura R., CNM, MSN, Review of "The Joy of Uncircumcising! Restore Your Birthright and Maximize Sexual Pleasure," *JOURNAL OF NURSE-MIDWIFERY*, vol. 38, no. 6, November/December 1993.
- Thompson, Hugh C., M.D., et al., "Report of the Ad Hoc Task Force on Circumcision," *PEDIATRICS*, vol. 56, no. 4, October 1975.
- Thompson, Robert S., M.D., "Is Routine Circumcision Indicated in the Newborn?: An Opposing View," *THE JOURNAL OF FAMILY PRACTICE*, vol. 31, no. 2, 1990.
- Thornton, Jim, "Reverse Circumcision," *MEN'S CONFIDENTIAL*, October 1993.
- Tushnet, Leonard, M.D., "Uncircumcision," *MEDICAL TIMES*, vol. 93, no. 6, June 1965.
- U.S. Public Health Service, cited by Marilyn Milos, R.N., in *NOCIRC NEWSLETTER*, vol. 2, no. 1, Winter 1987.
- Van Biema, David, "Miracles, U.S.A.," *LIFE*, vol. 14, no. 9, July 1991.
- Van Biema, David, "The Journey of Our Lives," *LIFE*, October 1991, from David Cohen's *THE CIRCLE OF LIFE: RITUALS FROM THE HUMAN FAMILY ALBUM*, San Francisco, Harper, 1991.
- Van Buren, Abigail, "Don't Pierce Those Baby Ears," *Dear Abby*, *SAN FRANCISCO CHRONICLE*, Wednesday, February 6, 1991.
- Vermooten, Vincent, M.D., cited by Jane E. Brody in "A Restudy Urged on Circumcision," *NEW YORK TIMES*, September 20, 1970.
- Wählin, Nils, "Triple Incision Plasty? A Convenient Procedure for Preputial Relief," *SCANDINAVIAN JOURNAL OF UROLOGY AND NEPHROLOGY*, vol. 26, no. 2, 1992.
- Wall, Roscoe L., Jr., M.D., "Routine Circumcision? Recent Trends and Concepts," *NORTH CAROLINA MEDICAL JOURNAL*, vol. 29, no. 3, March 1968.
- Wallerstein, Edward, *CIRCUMCISION: AN AMERICAN HEALTH FALLACY*, New York, Springer Publishing Co., 1980.
- Wallerstein, Edward, *WHEN YOUR BABY BOY IS NOT CIRCUMCISED*, Seattle, WA, Pennypress, Inc., 1982.
- Wallerstein, Edward, "The Case of the Marble Foreskin," *FORUM*, September 1983.
- Warren, John P., FRCP & Bigelow, Jim, Ph.D., "The Case Against Circumcision," *BRITISH JOURNAL OF SEXUAL MEDICINE*, vol. 21, no. 5, September/October 1994.
- Watson, Stan J., M.D., Letter to the Editor, *PEDIATRICS*, vol. 80, no. 5, November 1987.
- Weiss, Charles, "A Worldwide Survey of the Current Practice of Milah (Ritual Circumcision)," *JEWISH SOCIAL STUDIES*, January 1962.
- Weiss, Charles, M.D., Ph.D., "Ritual Circumcision," *CLINICAL PEDIATRICS*, vol. 1, no. 1, October 1962.
- Wilkes, Edward T., M.D., "Should Your Son Be Circumcised?," *PARENTS' MAGAZINE*, vol. 34, no. 2, February 1959.
- Williams, George L., M.B., Ch.B., FRACP, "Newborn Circumcision: An Enigma of Health," Second International Childbirth Conference, Sydney, Australia, October 7, 1992.
- Williams, Nigel, et al., "Why Are Children Referred for Circumcision?," *BRITISH MEDICAL JOURNAL*, vol. 306, January 2, 1993.
- Winberg, Jan, et al., "The Prepuce: A Mistake of Nature?," *THE LANCET*, March 18, 1989.
- Winn, Denise, "A Campaign to Save the Foreskin," *INDEPENDENT*, London, Tuesday, April 20, 1993.
- Wiswell, Thomas E., Major, M.C., USA & Roscelli, John D., LTC, M.C., USA, "Corroborative Evidence for the Decreased Incidence of Urinary Tract Infections in Circumcised Male Infants," *PEDIATRICS*, vol. 78, no. 1, July 1986.
- Wiswell, Thomas E., M.D., et al., "Circumcision in Children Beyond the Neonatal Period," *PEDIATRICS*, vol. 92, no. 6, December 1993.
- Wolfson, Dr. Jerome, *PITTSBURGH POST GAZETTE*, cited by Marilyn Milos, R.N., in *NOCIRC NEWSLETTER*, vol. 2, no. 1, Winter 1987.
- Wright, J.E., M.B., B.S., FRACS, FACS, "Further to 'The Further Fate of the Foreskin,'" *THE MEDICAL JOURNAL OF AUSTRALIA*, vol. 160, February 7, 1994.
- Wright, J.E., M.B., B.S., FRACS, FACS, "The Treatment of Childhood Phimosis With Topical Steroid," *THE AUSTRALIAN AND NEW ZEALAND JOURNAL OF SURGERY*, vol. 64, no. 5, May 1994.
- Wynder, Ernest L., M.D., et al., "A Study of Environmental Factors in Carcinoma of the Cervix," *AMERICAN JOURNAL OF OBSTETRICS AND GYNECOLOGY*, vol. 68, no. 4, October 1954.
- Ying, He & Zhou, Xiu-hua, "Balloon Dilation Treatment of Phimosis in Boys," *CHINESE MEDICAL JOURNAL*, vol. 104, no. 6, 1991.
- Zavales, Anastasios, Ph.D., "Transcultural, Multireligious, & Interdisciplinary Dimensions of Appropriating Universal Paradigms Regarding the Human Rights Challenge of Genital Mutilation," Third International Symposium on Circumcision, College Park, MD, May 22-25, 1994.
- Zweifler, John, M.D., "Teaching Residents Circumcision," *FAMILY MEDICINE*, vol. 26, no. 1, January 1994.

---

# Glossary

---

**Adhesions:** bodily tissues abnormally grown together after inflammation.

**Aposthia:** congenital absence of the foreskin (a birth defect).

**Bris milah:** Bris is a Hebrew word meaning “covenant” or promise (with God). Alternate spellings include: brith, brit, berith, or briss. Bris milah is the Jewish ritual circumcision ceremony normally performed on the eighth day of the child’s life.

**Castration:** removal of the testes.

**Cauterization:** burning.

**Cervix:** the narrow outer end of the uterus.

**Circumcision:** the amputation of all or part of the foreskin (prepuce) of the male or female.

**Clitoridectomy:** removal of the clitoris.

**Clitoris:** female sexual organ corresponding to the penis.

**Corona:** the prominent, elevated, circular border of the glans penis.

**Coronal sulcus:** the groove that encircles the penis where the glans meets the penile shaft.

**Correlation:** a statistic which indicates the extent to which two events or conditions occur or exist together.

**Decircumcision:** restoration or reconstruction of the foreskin.

**Dorsal slit:** Dorsal refers to the back of a structure, e.g. the top of the one’s own penis that one sees when looking down upon it. A dorsal slit is a procedure used to enlarge the orifice of the foreskin rather than resort to circumcision.

**Electrocautery device:** a device which uses electricity to sever tissue rather than cutting. The procedure simultaneously severs the tissue and cauterizes the wound.

**Epispasm:** a Greek term eventually used for most ancient forms of foreskin restoration and reconstruction.

**FGM:** female genital mutilation.

**Fibula:** a clasp used in ancient times to fasten the foreskin closed over the glans.

**Flaccid:** the unerect penis.

**Foreskin:** the prepuce. The loose retractable skin sheath at the end of the natural (uncircumcised) penis or clitoris. In the female, sometimes called the hood.

**Frenar band:** a tightly pleated zone near the tip of the foreskin. This band narrows the foreskin orifice and is continuous with the frenulum.

**Frenulum (frenum):** the fold of membrane on the underside of the glans where the inner foreskin lining is attached to the penis. Frenulum is now the preferred term in the U.S.

**Glans penis (glans):** the rounded head at the end of the penis.

## Infibulation

**Female:** a form of genital mutilation, usually accompanied by primitive forms of female circumcision, in which the vaginal opening is stitched closed as a method of preserving virginity.

**Male:** the stitching or otherwise fastening of the foreskin together in front of the glans, often as a means of preventing masturbation. In ancient Rome, accomplished by means of a fibula.

**Intact:** untouched, uninjured. The normal, uncircumcised penis.

**Keratin/keratinization:** the dry, sometimes horny material that collects on skin or mucosal surfaces in response to excessive friction and exposure or to the deprivation of smegma.

**Kynodesme:** a tie used in ancient times to hold the foreskin closed over the glans.

**Labia:** literally, lips. There are two folds of tissue: the larger, labia majora, covers the vulva; the smaller, labia minora, lies within the labia majora.

**Liposuction:** the removal of excess fat by means of suction.

**Meatal stenosis:** a condition in which the urinary opening of the glans penis becomes constricted due to inflammation or infection.

**Meatus:** a passage or an opening. The urinary meatus in the male is located at the tip of the penis; in the female, it is located between the clitoris and the vagina.

**MGM:** male genital mutilation.

**Mohel (mohelet):** a Jewish ritual circumciser.

**Neonate:** newborn.

**Orifice:** a mouth or opening. In the foreskin, the tip or opening normally narrowed by the frenar band.

## Paraphimosis

**Acquired:** in the infant, caused by forcing the naturally tight or adherent foreskin behind the glans.

**Congenital/true:** a rare condition in which a tight, narrow foreskin opening is forced behind the glans and is too tight to permit the foreskin to return to its normal position over the glans.

**Penile sheath:** the continuous covering of the penis from the abdomen to the corona of the glans, includes both the skin covering the shaft of the penis and the foreskin in an intact male.

## Phimosis

**Acquired:** a complication caused by forceful retraction of the infant’s foreskin before it has separated naturally from the glans.

**Congenital/true:** a rare condition in which the foreskin cannot be retracted after the age of puberty.

**Prepuce:** the more precise medical term for the foreskin.

**Prophylactic:** preventing or guarding from disease.

**Reconstruction, of the foreskin:** more recently reserved to refer to surgical re-creation of the foreskin.

**Restoration, of the foreskin:** has referred to any form of foreskin re-creation. More recently, re-creation by nonsurgical means.

**Retraction, of the foreskin:** the foreskin unfolding back off the glans onto the shaft of the penis, either pulled back manually or unfolding spontaneously during an erection.

**Scarification, of the glans:** the result of stripping the adherent infant foreskin from the glans in order to perform an infant circumcision.

**Smegma:** the naturally occurring substance that collects beneath the foreskin of the penis and around the clitoris and labia. It is mainly composed of dead skin cells.

**Sulcus (see coronal sulcus)**

**Sunna:** the mildest form of ritual female genital mutilation, the removal of the hood and the tip of the clitoris.

**Symbolic circumcision:** original form of Jewish circumcision, practiced for approximately 2,000 years before the introduction of periah.

**Synechia:** the natural membrane which holds two body structures together. In the infant penis, the natural membrane between the foreskin and the glans.

**Trauma:** any severe wound or injury, physiological or psychological.

**Urethra:** the tube-like conduit (for urine and/or semen) that connects the bladder to the exterior of the body.

**UTI:** urinary tract infection.

**Vagina:** the genital canal which leads from the uterus to the vulva.

**Venereal disease:** any disease transmitted by sexual contact.

**Ventral slit:** Ventral refers to the ‘belly’ or front side of the body, the under surface of the penile shaft. A ventral slit is a procedure used to enlarge the orifice of the foreskin rather than resort to circumcision.

**Vulva:** the visible, external parts of the female genitalia.

---

## Resources (revised October, 2002)

---

When writing to the following centers or individuals, always include a S.A.S.E.

### **MGM (Male Genital Mutilation)**

The following North American centers either provide information and support to circumcised men or, along with their focus on various men's issues, have taken a stand against routine male circumcision.

#### **National Organization of Restoring Men**

NORM International Headquarters

R. Wayne Griffiths, M.S., M.Ed.

Co-founder and Executive Director

3205 Northwood Drive, Suite 209, Concord, CA 94520-4506

Tel: (510) 827-4077 Fax: (510) 827-4119

[waynerobb@aol.com](mailto:waynerobb@aol.com)

[www.norm.org](http://www.norm.org)

This center coordinates the NORM support groups worldwide, as well as oversees the support NETWORK for men who are restoring their foreskin. For an initial information packet, please send \$4.00 to cover printing and postage.

#### **UNCircumcising Information and Resources Center**

UNCIRC

Jim Bigelow, Ph.D.

address correspondence in care of NORM. (see above)

Tel/Fax: (408) 375-4326

This center provides information and support for circumcised men who are interested in foreskin restoration.

#### **Internet Foreskin Restoration Information**

Gary Burlingame

1111 12th Street, Bellingham, WA 98225-6617

Tel: (360) 671-5150 Fax: (360) 714-0701

[gburlin@eskimo.com](mailto:gburlin@eskimo.com)

#### **Men's Rights, Inc.**

Fredric Hayward

P.O. Box 163180, Sacramento, CA 95816

Tel: (916) 484-7333

[www.backlash.com/content/gender/1995/5-may95/page11.html](http://www.backlash.com/content/gender/1995/5-may95/page11.html)

[www.pelican.guild.uwa.edu.au/editions/95-2/Page12.html](http://www.pelican.guild.uwa.edu.au/editions/95-2/Page12.html)

#### **The National Men's Resource Center**

Working since 1982 to end men's isolation

Gordon Clay, Executive Director

P.O. Box 1080, Brookings OR 97415

[www.menstuff.org](http://www.menstuff.org). 175 megabytes of information, resources, issues, books, and events.

#### **National Organization to Halt the Abuse and Routine Mutilation of Males**

NOHARMM

Tim Hammond

P.O. Box 460795, San Francisco, CA 94146

Tel: (415) 826-9351

[www.noharmm.org](http://www.noharmm.org)

This Center's primary mission is to educate men about the benefits of genital integrity and the adverse consequences of circumcision and to encourage men to speak out for the rights of children to bodily integrity and self-determination.

#### **MGM Worldwide**

Routine circumcision has been practice by virtually every English speaking nations, as well as others, since late in the 19<sup>th</sup> century. For support centers in countries other than the United State, go to

[www.norm.org](http://www.norm.org) .

#### **Intact Baby Movement**

The following North American centers provide information on available books, pamphlets, magazines, audio- and videotapes, etc., which seek to inform the public about genital mutilation worldwide, particularly infant male circumcision in the U.S. and other English-speaking countries.

#### **NOCIRC National Headquarters**

Marilyn Milos, RN, Executive Director

P.O. Box 2512, San Anselmo, CA 94979-2512

Tel: (415) 488-9883 Fax: (415) 488-9660

[www.nocirc.org](http://www.nocirc.org)

Dedicated to making a safer world, NOCIRC is a non-profit educational organization committed to securing the birthright of male and female children and babies to keep their sexual organs intact. On March 15, 1986, a group of healthcare professionals in the San Francisco Bay Area announced the founding of the National Organization of Circumcision Information Resource Centers (NOCIRC); the first national clearinghouse in the United States for information about circumcision. In its first decade, NOCIRC grew into an international network and now has more than 110 centers worldwide.

For the list of regional centers, go to [www.nocirc.org](http://www.nocirc.org) and see NOCIRC Centers. There are centers across the U.S. and in a number of other countries.

### **Circumcision Resource Center**

Ron Goldman, Ph.D., Executive Director  
P.O. Box 232, Boston, MA 02133  
Tel: (617) 523-0088  
[crc@circumcision.org](mailto:crc@circumcision.org)  
<http://www.circumcision.org>

A nonprofit educational organization with the purpose of informing the public and professionals about the practice of circumcision. The Center is a valuable source of circumcision information for parents and children's advocates; childbirth educators and allied professionals; medical, mental health, and academic people; Jews; and all others who wish to learn more.

### **D.O.C (Doctors Opposing Circumcision)**

George C. Denniston, M.D. Executive Director  
2442 NW Market Street, Suite 42  
Seattle WA 98107  
[gcd@u.washington.edu](mailto:gcd@u.washington.edu)  
<http://doctorsopposingcircumcision.org/>

Doctors opposing circumcision was founded 1995. Within one year, there were members in all 50 States of the United States, all 10 provinces and 2 territories of Canada and now in countries on six continents. This organization works primarily in the United States, Canada, Australia, New Zealand and Great Britain, reaching medical students to inform them about the procedure that they will shortly be told to perform on infants. These students are invited to visit our website on the Internet, and study the brief Foreskin curriculum.

### **Attorneys for the Rights of the Child (ARC)**

J. Steven Svoboda, Esq.  
2961 Ashby Avenue, Berkeley, CA 94705  
Tel/Fax: 510-595-5550  
[arc@post.harvard.edu](mailto:arc@post.harvard.edu)  
[www.arclaw.org](http://www.arclaw.org)

An international network of attorneys and supporters now addressing the multi-faceted issue of genital mutilation of children, particularly the practice of male circumcision. ARC is a non-profit organization founded to secure equal protection for, and broaden judicial and public recognition of, children's legal and human rights to bodily integrity and self-determination.

### **FGM (Female Genital Mutilation)**

For information, go to [www.norcirc.org](http://www.norcirc.org) and see Affiliated Organizations page.

### **Alternative Bris Ceremonies**

Many in the Jewish community are now questioning the ritual of infant male circumcision. For information on alternatives to the rite, go to [www.nocirc.org](http://www.nocirc.org) and see the Circumcision and Religion page, or go to your search engine and enter "alternative bris"

### **Books/Magazines/Publications**

CIRCUMCISION: AN AMERICAN HEALTH FALLACY, Edward Wallerstein, New York, Springer Publishing Co., 1980. (This book is out of print but may be available through interlibrary loan.)

CIRCUMCISION: THE HIDDEN TRAUMA, Ronald F. Goldman, 1997. [crc@circumcision.org](mailto:crc@circumcision.org)

CIRCUMCISION: THE PAINFUL DILEMMA, Rosemary Romberg, South Hadley, MA, Bergin & Garvey Publisher, Inc., 1985. (This book is out of print but may be available through interlibrary loan.)

CIRCUMCISION: WHAT EVERY PARENT SHOULD KNOW, Anne Briggs, Earlysville, VA, Birth and Parenting Publications, Inc., 1985. (No longer available.)

CIRCUMCISION EXPOSED, Billy Ray Boyd, 1998  
[www.crossingpress.com](http://www.crossingpress.com)

DOCTORS RE-EXAMINE CIRCUMCISION, is the latest edition Thomas J. Ritter, M.D., and George C. Denniston, M.D.  
[gcd@u.washington.edu](mailto:gcd@u.washington.edu)  
Order from NOCIRC - PA P.O. Box 103, Mountville, PA 17554  
[musiciansunited@aol.com](mailto:musiciansunited@aol.com) Or call 717-285-2839

THE JOY OF BEING A BOY, Elizabeth Noble, P.T., with Leo Sorger, M.D., 1994. (This book is now out of print.)

NOCIRC Symposia Books from Lausanne, Oxford and Sydney Symposia. [www.norcirc.org](http://www.norcirc.org)

QUESTIONING CIRCUMCISION: A JEWISH PERSPECTIVE, Ronald F. Goldman, 1998. [crc@circumcision.org](mailto:crc@circumcision.org)

SAY NO TO CIRCUMCISION!, Thomas J. Ritter, M.D., George C. Denniston, M.D., Aptos, CA, Hourglass Book Publishing, 1992. (No longer in print.) Replaced by DOCTORS RE-EXAMINE CIRCUMCISION. (See above.)

WHAT DOCTORS WON'T TELL YOU, 1994.  
AWAKENINGS: A PRELIMINARY POLL OF CIRCUMCISED MEN, 1994. [www.noharm.org](http://www.noharm.org).

WHAT YOUR DOCTOR MAY NOT TELL YOU ABOUT CIRCUMCISION  
Paul Fleiss, M.D. and Frederick M. Hodges, DPhil  
[www.norcirc.org/publish](http://www.norcirc.org/publish) for ordering information.

### **Manufactured Restoration Devices and/or Methods**

For information on commercial devices currently available, see chapter 18 and/or go to [www.norm.org](http://www.norm.org).

# Index

- AA 220  
Abcarian, Robin 228  
Abraham/Abrahamic covenant 8, 38, 55  
ACA 220  
Adams, Cecil (*The Straight Dope*) 30, 217, 222, 230  
adhesions  
    incorrect term for natural membrane in  
        newborn 33-34  
    true/acquired 34, 43, 75  
Africa/African 37-38, 45, 48, 71-72, 215-216  
AIDS  
    (see venereal disease)  
Alcalen, Erlinda 51, 225  
Aldeeb, Sami A. 219, 230  
Alexander the Great 61  
Alter, Gary J. 227  
Altschul, Martin S. 36, 223  
Amato, Dante 32, 223  
American Academy of Pediatrics (AAP) 30, 33, 34,  
    36, 114, 130, 218  
anatomy  
    of circumcised penis 20-23  
    of natural penis 12-15  
Anders, T.F. 228  
Angell, Dwight E.M. 230  
Angell, Sir Norman 46  
Angell, Rich 228  
anger/angry 5-6, 50, 52-53, 99, 102-103, 111, 113,  
    115, 117, 120, 127, 129-130, 214-215,  
    218-219, 222  
    (see circumcision, infant, effects)  
Antiochus IV, Seleucid Emperor 62-63, 64  
Antoninus Pius 64, 66  
aposthia (birth defect) 23-24  
Apostle Paul 66-67, 83, 86-87  
Apt, Adolf 39-40, 224  
Argenta, Louis C. 131, 229  
Artz, J. Sheldon 124-125  
Austad, Eric David 131, 132, 229  
Australia/Australian 129, 195-196, 211, 221,  
    *Resources*  
Baldwin, James 93, 227  
Bar Kokba Uprising 56, 64  
Bauman, Eli 29  
Beaugé, Michel 223  
Belgium/Belgian 221, *Resources*  
Bergeson, Paul S. 82, 227  
Berkeley, B. 18, 70, 222, 227, 230  
Bigelow, Jim 217, 226, 227, 229, 230, *Resources*  
birth trauma 109-110  
birthing environment/procedures 36, 41, 95-96,  
    109-110  
Blackmon, Edward B. 41, 224  
Bliss, Shepherd 112  
Block, Jeanne H. 228, 230  
Bly, Robert 112  
body image 21, 49-50, 51, 113, 114-115, 116  
    (see circumcision, infant, effects)  
    (see self-image)  
Boyd, Billy Ray 128, 129, 229  
Bradshaw, John 111  
Brazelton, T. Berry 41, 108, 224, 228  
Briggs, Anne 43, 109, 128, 225, 228  
Brigman, William E. 220, 230  
bris milah 55-60  
    messisa 57  
    milah 55-56, 61, 86  
    periah 56-57, 59, 65, 66, 87  
Britain  
    (see Great Britain)  
Britton, Eve 230  
Bryk, Felix 57, 226  
BUFF 50, 125, 127, 128, 169, 228  
Burt, James C. 72-73  
California Medical Association (CMA) 42, 130  
Canada/Canadian 13, 29, 47, 123, 211, *Resources*  
cancer  
    cervical 38-39, 45  
    penile 26-27, 32, 39-40, 43-44  
    prostatic 39-40  
Carey, Joseph 223  
castration (treatment for masturbation) 70-71  
cauterization (treatment for masturbation) 70, 72  
Celsus, Aulus Cornelius 65, 67-68, 193, 200  
cervical cancer  
    (see cancer)  
Chaleman, R.J. 228  
Chandler, Cameron 230  
Chessare, John B. 32, 223  
chordee 81  
    (see penis, erections, bent)  
Christianity, attitude toward infant male circumcision  
    1st century 66-67  
    modern-day 8, 58, 70, 83-88, 105  
    need for new 219  
circumciser/s  
    effects on 96-99  
    indigenous peoples 215-216  
    motives of 58, 94-96  
    rated, mohel *v.* doctor 59  
circumcision  
    abnormal penis, contraindicated 81, 82  
    adults/older children, medical 27, 31-33, 46-  
        47, 211  
    alternatives, treatments/methods 32, 35, 75,  
        194-195  
    Christianity and infant circumcision  
        (see Christianity, attitude toward infant male  
            circumcision)  
    female/female genital mutilation (FGM) 48-49,  
        71-73, 130, 215-216, *Resources*  
    human rights  
        (see human rights issues)  
    infant  
        (see research, effects of circumcision, trauma  
            & long-term)  
        America, in 50-51, 54-55, 69-82, 83-88  
        effects, physical 19-27, 44-45, 56-57, 80, 97,  
            105, 218-219  
    effects, psychological 4-6, 40-41, 49-50, 89-  
        112, 114-115, 214-215, 218-219  
        (see anger, body image, self-image,  
            woundedness)  
    motives/reasons for 57-58, 89-112  
        hygiene 21, 26-27, 30-31, 54, 74, 102, 211  
        match father/peers 50-51, 98, 99-100,  
            102-103, 217  
        prevent disease and complications 7,  
            31-40, 54, 69, 73, 83-84, 211  
        preventive/treatment for masturbation 70-  
            72, 74  
    rate  
        (see rate of infant male circumcision)  
    risks/complications 23-24, 42-44, 57, 59, 75,  
        76, 80-82, 218-219  
        (see death)  
    Jewish/ritual  
        (see Jews/Judaism)  
    adults 60  
    ceremony  
        (see bris milah)  
    radical 54-55, 56-57, 67, 86-87  
        (see bris milah, periah)  
    symbolic 8, 55-56, 61, 86-87  
        (see bris milah, milah)  
    why in infancy? 57-58  
    methods/tools 74, 75-80  
    partial 35, 75  
Circumcision Resource Center 128, *Resources*  
circumferential purse-string suture 191-192, 207  
    (see surgical touch ups to restored foreskin)  
Circumstraint (circumcision board) 77, 80, 227  
    (see Olympic Medical Corp.)  
Clark, K.B. & M.P. 228  
clitoridectomy 48, 71-72  
    (see circumcision, female)  
cognitive dissonance 99, 102-103, 105-107, 112,  
    120  
Cohen, Arthur R. 228  
Cohen, David 227  
Cohen, Herman A. 59, 226  
Cohen, Mimis 229  
Condry, J. & S. 227  
Conference on Infants Studies, The First International  
    41, 224  
connective membrane/tissue (synechia) 13-15, 33-  
    34, 76, 82  
constriction of blood flow, tests for 143  
Cook, Linda S. 38, 224  
correlation, statistical 36, 37, 38, 40, 45  
    (see statistics)  
cries during infant circumcision 40-41, 49, 92, 93,  
    94, 96, 98, 104, 108-109, 210  
Cuckow, Peter M. 223  
Curran, James 38, 224  
death from infant circumcision 40, 42-44, 57  
decircumcision 66  
    (see foreskin restoration)  
defense mechanisms and circumcision 89-112, 120

- DeMeo, James 225  
Denmark/Danish 31, 35, 40  
Denniston, George C. 37, 40, 222, 224  
Denton, John 42, 225  
Deutsch, Morton 228  
Diamond, Jed 112  
Donahue, Phil (*Donahue*) 128  
dorsal slit 35, 44, 75  
    (see circumcision, alternatives)  
Eason, Julian D. 59, 226  
Ecumenics International, Inc. 219  
Edell, Dean 1, 128, 186, 229  
Edison, Thomas A. 182  
Edwardes, Allan 226  
Eiger, Marvin S. 37, 39-40, 224  
Egypt/Egyptian 48, 55, 58, 72, 84, 86, 92, 215  
electrocautery device(s) 42, 43  
electrolysis, touch up to restored foreskin 192  
Elting, L.M. 41, 224  
Emde, R.N. 228  
Emden, Rabbi Jacob 76  
Emmett, Anthony J.J. 223, 229  
England/English  
    (see Great Britain)  
epispasm 63, 67  
    (see foreskin restoration, ancient, methods)  
equilibrium, point of 168, 169-171  
erection, penile  
    (see penis, erections)  
Erickson, John A. 52, 128, 225, *Resources*  
ETHIC *Resources*  
expansion devices/procedures, stage III 169-181  
    alternative devices/procedures 182-186  
    manufactured devices/methods 147, 182, 186-187, *Resources*  
Faria, Duyen 204-205  
Farrell, Warren 112, 217, 230  
Feins, Neil R. 126, 206-207, 228, 230  
female circumcision  
    (see circumcision, female)  
Feriz, H. 68, 196-197, 226, 229  
Festinger, Leon 228  
fever  
    (see infection after infant circumcision)  
Finer, Neil N. 230  
Fink, Aaron J. 31, 37, 47, 48, 49-50, 69, 130, 222, 224, 225, 226  
Finland/Finnish 31, 40  
Fiscus Judaicus (circumcision tax) 64, 66, 120  
Fleiss, Paul M. 30, 34, 222, 223  
foreplay  
    (see foreskin, natural and/or restored, sexual function)  
foreskin/prepuce, natural 11-18  
    care of  
        infant 30-31, 33-34  
        older child/adult 30-31, 34-35  
    development 13-15, 33-34  
    function, general 13-15, 29-30  
    'medical waste' 204-205, 210  
    nonretractable in infant 13-15, 33-34  
    reputation in America 17-18, 31-33, 69-71, 74-75, 113  
    research, used in 204-205, 210  
    sexual/sensual function 3-4, 15-17, 24-26, 29-30  
    structure 12-13, 14  
foreskin, restored 138  
    finishing touches to 138, 188-192, 206-207  
    retractability, excessive 180, 188-192  
    sensitivity, glans/mucous tissue 135-136, 158-159, 167, 180  
    sexual/sensual function 114, 134-138, 158, 159, 167, 179, 181  
foreskin restoration/reconstruction  
    ancient, Jews 61-67  
        methods 63-64, 65-66  
        motives/reasons 62-63, 64, 118-120  
    Jews under Hitler 67-68  
    modern-day  
        alternative devices/procedures 182-187  
        cooperative approach, proposed 206-207  
        Jewish awareness 68  
        manufactured devices/methods 147, 182, 186-187, *Resources*  
        motives/reasons 97, 113-120, 197  
        restoration movement 121-130  
        results of  
            (see foreskin, restored)  
        skin-expansion system 131-181  
            stage I 152-160  
            stage II 161-168  
            stage III 169-181  
        social attitudes toward 52-53, 118-120, 214-215  
        support during  
            (see support during nonsurgical restoration)  
        surgical procedures/plastic surgery 68, 121-122, 123, 126, 193-205  
            free graft 195-196  
            platinum ring, implanted 124-125, 194  
            rotated graft 200-201  
            scrotal graft 196-200  
            skin expansion 201-202  
            Z- and/or Y-plasties 194-195, 206  
Fraga, Juan R. 34, 223, 225  
France/French 38, 40  
Frاند, M. 226  
Frank, J.D. 223  
Freedman, Lawrence D. 30-31, 222  
frenar band 13, 14, 138, 184, 191-192  
frenulum 13, 14, 23, 55, 56, 66, 75, 76, 81, 123, 138, 158  
Gairdner, Douglas 30, 34, 35, 219, 222, 223, 230  
Ganiats, Theodore G. 32, 222  
Gardner, A.M.N. 226  
Garduno-Espinosa, Juan 32, 223  
Gayman, Dan 84, 223  
Gelbaum, Ilene 95-97, 210, 227  
Gellis, Sydney S. 43, 225  
Gentile, Anthony 51, 225  
Germany/German 60  
Gershman, Martin 50, 225  
Gilbaugh, James H. 25-26, 35, 81, 136, 222, 223, 227, 229  
glans/glans penis  
    external organ (circumcised penis) 22-23  
        aging 7, 23, 80  
    internal organ (intact penis) 15-17  
    sensitivity of  
        circumcised penis 23, 44-45, 57, 80, 97, 105  
            (see circumcision, infant, effects)  
        intact penis 3-4, 15-17, 29-30, 44-45  
        restored penis 113-114, 135-136, 158, 159, 167, 180, 186, 188  
gliding mechanism 3-4, 11, 17, 25-26, 29-30, 138, 181  
goals of restoration 138, 149, 159-160, 168, 178-181, 188-189  
Goldman, Ronald F. 60, 128, 219, 226, *Resources*  
Goldstein Mfg. Co. 77  
    (see Gomco Clamp)  
Gomco Clamp 59, 77, 78, 95, 108  
    (see Goldstein Mfg. Co.)  
Goncalves, Fernando 227  
gonorrhoea  
    (see venereal disease)  
Goodman, R. Cole 134, 229  
Goodman, Terri 131, 229  
Goodwin, Willard E. 114, 126, 133, 193, 197, 199-200, 201, 228, 229, 230  
Gordon, Andrew 230  
Gounen, S. 230  
Grace, Beth 227  
Graham, Saxon 110, 228  
Great Britain/British 37, 38, 54, 57, 59, 70, 129, 200, 211, 212, 219, 221, *Resources*  
Greer, Donald M. 124, 126, 197-199, 228, 229  
Griffiths, D. 223  
Griffiths, R. Wayne 97, 129, 175, 186, 188, *Resources*  
Grimes, David A. 41, 224  
Grossman, Elliot A. 40, 76-80, 82  
Gulf Coast Infant Circumcision Information Center 50, 128  
Hadrian, Emperor 64  
Hall, Robert G. 229  
Hammond, Tim 128, 129-130, 225, 230, *Resources*  
Hand, Eugene A. 57, 225, 226  
Hellenic Period/Hellenism 61-64, 65, 119-120  
hemorrhage after infant circumcision 42, 77, 82  
    (see circumcision, infant, risks/complications)  
Herodotus 58  
Herrera, Alfredo J. 230  
Hitler/Nazi 7, 67-68, 93, 118, 193, 196-197  
Hoffman, S. 223, 229  
Holland/Dutch 68, 196  
Hollister Corp. 77  
    (see Plastibell)  
Holt, L. Emmet, Jr. 71, 72  
homosexuality, foreskin restoration and 52, 53  
Hoppe, Art (*Art Hoppe*) 104, 228  
Horton, Charles 49, 202

- Hosken, Fran P. 227, *Resources*
- Howard, Cynthia R. 230
- human rights issues
- rights of the individual to his body 6-7, 27, 46, 47-49, 75, 87-88, 129-130, 210, 214, 216-217, 218-220
  - rights of the parents to circumcise their child 46, 47-49, 204, 209-210
  - women's rights 49, 74-75, 216-217, *Resources*
- humor and infant circumcision 93, 97, 104-105, 110-111
- hygiene
- (see circumcision, infant, motives for)
  - (see Jews, circumcision, health or holiness?)
  - (see penis, infant and/or natural/intact, care of)
- hypersensitivity of glans due to infant circumcision 24
- (see circumcision, infant, risks/complications)
- Illingworth, Ronald S. 34, 223
- infection after infant circumcision 40, 42-44, 82
- (see circumcision, infant, risks/complications)
- infibulate/infibulation 70, 72
- insurance, coverage for routine circumcision/foreskin restoration 202, 212
- Intact Baby Movement 127-128, *Resources*
- INTACT Educational Foundation 127
- International Symposium(a) on Circumcision *Resources*
- First 36
  - Second 13, 29, 33, 60, 87, 100
  - Third 60, 219
- Internet Foreskin Restoration Mailing List *Resources*
- Isaac, Erich 58, 226
- Isenberg, Seymour 41, 224
- Italy/Italian 38
- Jacobs, A.J. 223
- Jacobson, B. 109-110, 228
- James, Theodore 226
- James, William 47, 225
- Jews/Judaism
- circumcision
    - ceremony
      - (see bris milah)
      - alternative ceremony 59-60, *Resources*
    - differing attitudes toward
      - Conservative 59
      - Orthodox 58-59, 61, 84
      - Reform 60, 219
    - health or holiness? 58-59, 86-88
    - history/development 54-60
      - radical 56-57
      - symbolic 55-56, 61, 86-87
      - why in infancy? 57-58
    - foreskin restoration 61-68, 118-120
    - recircumcision
      - after restoration 66
      - after insufficient infant circumcision 56-57
      - risks/complications 57, 59
  - Johns Hopkins Hospital 42
  - Johnson, Virginia E. 44-45, 225
  - Joseph, Max 226
  - Josephus, Flavius 61, 63, 64, 84
  - JOURNAL OF NURSE-MIDWIFERY 129, 217
  - JOURNEYMEN, survey by 49-50, 218
  - Judaism
    - (see Jews/Judaism)
  - Judeo-Christian influence in America 54-55, 70, 90-91
  - Kaiser Permanente 36, 95-96
  - Kaplan, George W. 222
  - Katchandourian, Herant A. 223
  - Keen, Sam 112
  - Kelleher, Ruth E. 229
  - Kelley, Charles 51, 225
  - keratin/keratinization 22-23, 57
    - (see circumcision, infant, effects)
  - Kikiros, C.S. 223
  - King, Lowell 224
  - Kinsey Institute, The 50
  - Kirya, Christopher 41, 224, 230
  - Kistler, S.L. 74, 227
  - Klein, Fred 29
  - Kohler, Kaufmann 55, 56, 225, 227
  - Krauss, Robert M. 228
  - Kunin, Samuel A. 97, 228
  - Kynodesme 62
    - (see foreskin restoration, ancient, methods)
  - Lafferty, P.M. 223
  - Landers, Ann (*Ann Landers*) 39, 224
  - Lattimer, John K. 134, 229
  - Lawler, Frank H. 32, 223
  - Levin, S. 77, 226, 227
  - Levitt, Selwyn B. 43, 225
  - Lewis, Alfred Allan 29-30, 222
  - LIFE (magazine) 70, 92-93
  - Lightfoot-Klein, Hanny 228, *Resources*
  - Lilienfeld, Abraham M. 110, 228
  - love surgery 72-73, 227
  - lubrication, need for artificial 25-26, 80
  - Lunde, Donald T. 223
  - Lynch, M.J. 200-201, 229
  - Maccabean Age/Revolt 59-60, 64
  - Macris, Donna 217, 230
  - MADD 220
  - Maden, Christopher 40, 224
  - Maimonides, Moses 57-58, 84, 226, 227
  - males, cultural attitudes toward 71, 89-93, 102, 103-104, 110-112, 212-217
  - manufactured devices/methods 147, 182, 186-187, *Resources*
  - Marchbanks, Howard 41, 224
  - Marcus, Jeffrey 229
  - Marino, Leonard J. 36, 223
  - Marschall, Michael 229
  - Masters, William H. 44-45, 225
  - masturbation, circumcision as treatment for 19, 70-72, 74
    - (see circumcision, infant, motives for)
  - Matturri, L. 133, 229
  - McDonald, C.F. 227
  - McKay, R.J. 34, 223
  - McMillen, S.I. 26-27, 29, 38, 39, 58, 74, 84, 87, 222, 224, 226, 227
  - Mead, Margaret 208
  - meatal stenosis 15, 23-24
    - (see circumcision, infant, risks/complications)
  - meatus, foreskin as protection for 15, 23-24
  - Medical Ethics Network *Resources*
  - Meeres, Edward E. 229
  - Melendy, Mary 69
  - Menninger, Karl 89
  - MEN'S CONFIDENTIAL 49
  - men's rights
    - (see human rights issues)
  - Men's Rights, Inc. 112, *Resources*
  - men's self-help organizations 128-130, 220-221, *Resources*
    - (see NOHARMM, NORM)
  - Mercier, O.F. 123, 228, 229
  - messisa
    - (see bris milah)
  - metzitzah
    - (see messisa)
  - mezziza
    - (see messisa)
  - Michelangelo's David 55-56
  - milah
    - (see bris milah)
  - military, attitude toward male circumcision 69
  - Milos, Marilyn 33, 103, 110, 127, 128, 206, 217, 230, *Resources*
  - Minuchin, P.P. 230
  - mishaps of infant circumcision 42-43, 59, 80-82
    - (see circumcision, infant, risks/complications)
  - mizizah
    - (see messisa)
  - mohel/mohelet 54, 57, 59, 77, 95-97, 210
  - Mohl, Paul C. 52, 225, 229
  - Money, John 43, 52, 225
  - Morgan, David Z. 228
  - Moslems 219
  - Moss, C.L. 226
  - Moss, Lisa Braver 60, 226
  - mutilation, genital
    - male (MGM), circumcision as 4-5, 6, 39, 52, 60, 62, 71, 93, 96-97, 116, 128, 129-130, 179, 215-216, 218, 219, *Resources*
    - female (FGM) 71-73, 130, 215, *Resources*
    - severe complications of circumcision 40, 42-44, 59
      - (see circumcision, infant, risks/complications)
  - NATIONAL GEOGRAPHIC MAGAZINE, THE 122
  - National Men's Resource Center, The 112, *Resources*
  - Nazi
    - (see Hitler/Nazi)
  - Neifert, Marianne 47, 225
  - Network, The (support network of restoring men) 220, *Resources*
  - New Testament teachings on circumcision and other Old Testament ordinances 66-67, 83, 86-88
  - Newton, Lancelot 229
  - Noble, Elizabeth 33, 100, 101, 223



- NOCIRC 50, 103, 110, 116, **127**, 128, 129, 195, 212, 220, *Resources*
- nocturnal erections during restoration  
(see penis, erections, during skin-expansion system)
- NOHARMM 50, 113, 116, **122, 128, 129-130, 218-219, 221**, *Resources*
- Non-Circumcision Educational Foundation 127
- Non-Circumcision Information Center 127, *Resources*
- nonretractability of infant foreskin  
(see foreskin, nonretractable in infant)
- NORM 50, 110, 113, 116, **122, 129**, 178, 190, 200, **220-221**, *Resources*
- Norway/Norwegian 31, 40
- nurse-midwives 95-97, 217  
(see JOURNAL OF NURSE-MIDWIFERY)
- O'Connor, David 230
- odor of natural penis 26, 74
- Ohjimi, Toshihide & Hiroyuki 223
- Old Testament circumcision  
(see bris milah, milah)
- Old Testament law as medical prescription 38-39, 84-88
- Olenius, Michael 229
- Olympic Medical Corp. 77, 80, 227  
(see Circumstraint)
- Øster, Jakob 30, 34, 35, 222, 223
- Ostwald, Peter F. 108, 228
- Paige, Karen Ericksen 70, 227
- pain, during and after infant circumcision 40-41, 47-48, 54, 108-110, 214
- pain, psychological effects of circumcision  
(see circumcision, infant, effects)
- painful erections 44, 80-81  
(see circumcision, infant, effects)
- Pam, Leslie A. 109
- Panati, Charles 226
- paraphimosis 34-35  
acquired 34
- Parkash, Satya 223
- partial circumcision 35, 75  
(see circumcision, alternatives)
- Pasyk, Krystyna A. 132-133, 229
- Paul, Apostle  
(see Apostle Paul)
- Peaceful Beginnings 128, *Resources*
- Peltzman, Philip 108, 228
- penile cancer  
(see cancer)
- penis  
abnormal, circumcision contraindicated 81, 82  
amputation, treatment for masturbation 71  
circumcised 19-27  
development, foreskin 13-15, 33-34  
erections  
bent/angled, painful 44, 80-81, 126  
(see chordee & Peyronie's disease)  
during skin-expansion system 142, 144-145, 157, 161, 162, 163-164, 170, 171, 173, 174-175, 182-183, 185  
infant, intact 30-31, 33-34  
natural/intact 11-18  
care of 26-27, 30-31, 33-35, 73-75  
reputation in America 17-18, 30-33, 69-71, 74-75, 103-104  
sexual/sensual responsiveness 3-4, 15-17  
reputation in America 103-104  
Penn, Jack 121, 123, 124, 193, 195, 228  
periah  
(see bris milah)  
Peron, James E. 127  
Peyronie's disease 81, 126  
(see penis, erections, bent)  
Philo of Alexandria 58  
phimosis 24, 33-35, 54, 71, 75, 125, 194, 195, 199  
acquired 34, 43  
Physicians' Committee for Responsible Medicine 130  
pitted glans 22-23, 42-43, 82  
(see circumcision, infant, risks/complications)  
Plastibell 23, 76, 77, 79, 108-109  
(see Hollister Corp.)  
plastic surgery 42, 43, 53, 126, 131-132, 134, 201-202  
(see skin expansion, surgical)  
(see foreskin restoration, modern-day)  
platinum ring, implanted  
(see foreskin restoration, modern-day)  
pleasure dynamic 13, 16-17, 25, 138  
Pollack, Miriam 60, 226  
Pomeranz, Virginia E. 224  
Pondus Judeaus 66  
(see foreskin restoration, ancient, methods)  
Porter, J. 228  
Posner, Norman Ames 40, 224  
prepuce  
(see foreskin/prepuce)  
Presley, Elvis 107  
Preston, E. Noel 30, 39-40, 222, 224  
primal therapy  
(see birth trauma)  
probe (circumcision tool) 76-77  
prostatic cancer  
(see cancer)  
Pryor, J.P. 200-201, 229  
psychological effects of circumcision  
(see circumcision, infant, effects)  
purse-string suture  
(see circumferential purse-string suture)  
Purvis, Kenneth 211, 230  
rate of infant male circumcision  
Great Britain 219  
Denmark 31  
Norway 31  
U.S. 19, 21, 38, 51, 69, 113, 210  
Rathmann, W.G. 227  
Ravich, Abraham 37, 224  
Redwood Men's Center 112  
Reichelderfer, Thomas E. 34, 223, 225  
Reinisch, June 50  
Remain Intact Organization 127  
Remondino, P.C. 71, 227  
R.E.N.U. 128-129  
(see UNCIRC)  
research  
(see foreskin/prepuce, natural, 'medical waste' & research, used in)  
effects of circumcision, trauma 41, 108-110, 210  
effects of circumcision, long-term 49-50, 218-219  
foreskin, anatomy and function 13, 29-30, 32, 218  
need for cautious use of findings 7, 31-33, 36-40, 45, 217-218  
need for valid, cross-cultural 89-90, 92, 217-219  
researcher bias 36-37, 217-218  
resentment about circumcision 49-50, 51-52, 218-219  
toward doctors *Men's Voices*  
toward parents 105-107, 116-117, 218-219, *Men's Voices*  
restoration movement, modern-day 2, 121-130, 169-170  
Reuben, David 37, 222, 224  
reviews of this book, major journals 129, 217, *Back Cover*  
Richards, M.P.M. 220  
Ritter, Thomas J. 17, 22-23, 25, 128, 138, 222, 229  
Robertson, Pat 84, 227  
Rodgers, Richard 101  
Rogers, Peggy 225  
Romberg, Henry C. 77, 227  
Romberg, Rosemary 59, 128, 223, 225, 226, 228, *Resources*  
Roscelli, John D. 223  
rotated graft  
(see foreskin restoration, modern-day)  
Rothenberg, Moshe (Martin) 60, 226, *Resources*  
Rubin, J.Z. 230  
Rubin, Jody P. 226  
Russia/Russian 39  
Rutherford, Frederick W. 41, 223, 224  
Ryan, C. Anthony 230  
Sade, Marquis de 70  
Sally, Tim 129  
Saquet, Roger 127, *Resources*  
Sathaye, U.V. 227  
Scandinavia/Scandinavian 31  
(see individual countries)  
scarification of glans 22-23, 57, 80  
(see circumcision, infant, effects)  
Schlosberg, Charles 41, 98, 223, 224, 228  
Schlossberger, Norman M. 21, 49-50, 222, 225  
Schneider, T. 226  
Schoen, Edgar J. 33, 114, 130, 218, 228  
Schultz, Dodi 224  
Schultz, Terri 227  
Scott, Michael 148, 206-207  
Scott, W.W. 228

- scrotal implant, foreskin reconstruction  
(see foreskin restoration, modern-day)
- scrotum, surgical reconstruction of 134
- Seabrook, Charles 225
- self-help organizations, men's  
(see men's self-help organizations)
- self-image 21, 107-108, 113, 114-117, 179  
(see body image)  
(see circumcision, infant, effects)
- sense of wholeness 2, 114-117, 151, 179, 181
- sensitivity of glans/mucous tissue  
(see glans, sensitivity)
- sex-change surgery as result of circumcision 42, 43  
(see circumcision, infant, risks/complications)
- sex role and gender differences 71, 75, 90-91, 102, 103-104, 111-112, 212-217  
(see males, cultural attitudes toward)
- sexual/sensual function of the foreskin  
natural 3-4, 15-17, 24-26, 29-30  
restored 113-114, 134-138, 158-159, 166-167, 179, 181
- Shapiro, E.K. 230
- Sharlip, Ira 49
- Shenaq, Saleh M. 131
- Silber, Sherman J. 26, 29, 30, 38-39, 43, 44, 46, 48, 94, 222, 224, 225, 227
- Silberner, Joanne 223
- Simonsen, J. Neil 224
- skin bridge 43, 75, 81  
(see circumcision, infant, risks/complications)
- skin/tissue expansion  
nonsurgical 134  
(see foreskin restoration, modern-day)  
surgical  
foreskin reconstruction 201-202  
history, principles of 131-134
- skin graft/free graft  
(see foreskin restoration, modern-day)
- skin tag 81-82  
(see circumcision, infant, risks/complications)
- skin-expansion system  
(see foreskin restoration, modern-day)
- smegma 30, 39, 40, 72, 74, 75
- Snowman, L.V. 226
- Snyder, Howard M. 37, 224
- Snyder, James L. *Foreword*, 42, 225
- South Africa/South African 122, 123, 215-216
- Spach, David H. 31-32, 222
- Spain/Spanish 66
- Speert, Harold 39, 224
- Spence, Sir James 34, 223
- Spencer, Walter G. 229
- Spitz, René A. 71, 227
- Spock, Benjamin 50, 225
- Spratling, Edgar J. 71, 227
- Stalneck, Michael C. 134, 229
- Stang, Howard J. 41, 224, 230
- statistics 6-7, 32-33, 45, 217-219  
(see correlation, statistical)
- Stein, Martin T. 223
- Steiner, Richard 128
- Stemer, Rosalie 224
- Still, Eugene F., II 134, 229
- stitch tunnel 76, 81  
(see circumcision, infant, risks/complications)
- Stoddard, Kathy 225
- Strand, John 52, 124, 225, 228
- Streitfeld, Hank 43-44, 225
- Sunna 71-72  
(see circumcision, female)
- support for/during restoration, need of/lack of  
doctor 51-52, 99, 114, 119, 129, 140, 148, 172, 206-207, 210-211, 220  
partner 150-151  
support groups 122, 128, 129, 220-221,  
*Resources*
- surgical reconstruction of foreskin 42, 52, 65, 67-68, 122-123, 126, 129, 147, 193-205, 210-211  
(see foreskin restoration, modern-day)
- surgical touch ups to restored foreskin 138, 188-192, 207
- Swadey, John 38, 224
- Sweden/Swedish 36, 39-40, 109-110, 132
- synechia  
(see connective membrane/tissue)
- syphilis  
(see venereal disease)
- Taguchi, Yosh 34-35, 39-40, 41, 42, 46-47, 96, 223, 224, 225, 227, 228
- tape, selection of 141-142
- tattooing, after free-graft procedure 196
- Taylor, John 13, 29-30, 138, 218, 222
- Taylor, Laura R. 217, 229, 230
- teasing/ridicule for having natural penis 50-51, 74-75
- testosterone ointment 148, 206-207
- Testskin 204  
(see foreskin/prepuce, natural, 'medical waste' & research, used in)
- TheLAN, H.M. 228
- Thompson, Hugh C. 222
- Thompson, Robert S. 32, 37, 222, 224
- Thornton, Jim 225
- tie, foreskin restraint 62, 63, 183-184  
(see foreskin restoration, ancient, methods)
- tincture of benzoin 142
- tissue expansion  
(see skin/tissue expansion)
- 'tuck' procedures  
(see surgical touch ups to restored foreskin)
- Tucker, Patricia 43, 225
- Turkish circumcision 92
- Tushnet, Leonard 67-68, 226
- UNCIRC 2, 21, 44, 50, 51, 53, 68, 74, 75, 106, 107, 110, 113, 116, 117, **119, 128-129**, 140, 143, 147, 151, 182, 187, 190, 194, 196, 200, 203, 220, *Resources*
- uncircumcising  
(see foreskin restoration)
- United Kingdom  
(see Great Britain)
- urinary tract infection (UTI) 7, 31-33, 36-37, 59
- urination while wearing tape or a device 144, 153, 155-156, 162-167, 171, 172-173, 174-175, 178, 185, 186, 187
- Ussher, Bishop 55
- Van Biema, David 226, 227
- Van Buren, Abigail (*Dear Abby*) 49, 225
- venereal disease, circumcision as protection against 7, 37-38, 74  
AIDS 7, 37-38, 45  
gonorrhea 37-38, 70  
syphilis 37-38
- ventral slit 35, 75  
(see circumcision, alternatives)
- Vermooten, Vincent 37, 224
- Victims Speak 129
- Victorianism, effects of 70-71, 103-104
- violence, effects of 6, 91-92, 213-214  
(see circumcision, infant, effects)
- V.O.I.C.E. 50, *Resources*
- Wählin, Nils 223
- Wall, Roscoe 42, 224
- Wallace, Richard 225
- Wallerstein, Edward 19, 31, 38, 40, 42, 56, 71, 89, 128, 222, 223, 224, 225, 226, 227, 228, 230
- Warren, John P. 230, *Resources*
- Watson, Stan J. 36, 223
- Weiss, Charles 59-60, 226
- Werthmann, Milton W. 41, 224, 230
- White, Susan 131
- Wilkes, Edward T. 41, 224
- Williams, George L. 230
- Williams, Nigel 230
- Winberg, Jan 223
- Winn, Denise 230
- Wiswell, Thomas E. 31-32, 36-37, 45, 222, 223
- Wolfson, Jerome 51, 225
- women's rights  
(see human rights issues)
- Wood, Jeffrey 127
- woundedness, sense of 2, 4-6, 51-53, 111-112, 151, 194, 211, 219, 220-221  
(see circumcision, infant, effects)
- Wright, J.E. 223, 230
- Wynder, Ernest L. 39, 224
- Yellen, H.S. 77
- Ying, He 223
- Y-plasty 194-195, 206  
(see circumcision, alternatives)  
(see foreskin restoration, modern-day)
- Zanger, Russell 127
- Zavales, Anastasios 219, 230
- Zhou, Xiu-hua 223
- Z-plasty 194-195, 206  
(see circumcision, alternatives)  
(see foreskin restoration, modern-day)
- Zweifler, John 228

# What the Medical Journals Are Saying...

“This book...adds a new dimension to the argument against routine circumcision....The evolution of elective circumcision from a method to control masturbation and other ‘immoral’ sexual behaviors to an accepted, routine medical modality provides an interesting discussion....The psychological and sexual benefits of restoring the foreskin are expounded....”

***The Journal of the American Medical Association***

“[The book] is based on three premises: that infant circumcision is performed without consent; that circumcision diminishes penile sensation and therefore reduces sexual enjoyment; and that techniques of prepuce reconstruction can restore lost sensitivity to the glans penis....As Dr. Bigelow forcefully points out, there is little evidence that early circumcision confers any health gain to the individual in the longer term.”

***British Medical Journal***

“Bigelow’s book is...an important statement on a theme about which little is usually said, and on which most of us are ignorant. Urologists should read this book, which should make them consider alternatives...before offering circumcision...and take seriously the wishes of the troubled patient who asks to have his mutilation corrected.”

***British Journal of Urology***

“Jim Bigelow provides a profound service for the general public, for parents, physicians, and hopefully, most of all, for future generations of infant boys. In this multi-faceted, well-researched and clearly written book, he leaves no stone unturned....[It] provides abundant facts and information necessary to include circumcision in any discussion of child abuse.”

***The Journal of Orgonomy***

“In reading this book, one is forced to examine his/her own feelings about circumcision....[It] challenges us to think about new issues such as men’s rights and foreskin restoration.”

***Journal of Nurse-Midwifery***

“Most plastic surgeons will be surprised and many will be distressed at the information and arguments presented in this book....Particularly valuable are the insights on why some men feel so strongly about the desirability of the uncircumcised penis....It is an excellent introduction to a subject too long absent in plastic surgical literature.”

***Plastic and Reconstructive Surgery***

## About the Author

Jim Bigelow, Ph.D., brings to this book experience as a college professor, therapist, clergyman and author. He earned his doctorate in psychology at Claremont Graduate School and served as a Professor of Psychology at Whittier College. He has also lectured abroad extensively and pastored several Evangelical churches. Jim founded and is the director of UNCIRC. He is the father of two grown children and lives with his wife in California.